

FEATURES

- Pin-to-Pin Compatible with National DS26C32C
- Low Power CMOS Design
- Three-State Outputs with Enable Pin
- Meets the EIA RS-422 Requirements
- Low Propagation Delays
- High Speed

GENERAL DESCRIPTION

The ST26C32 is a CMOS quad differential line receiver designed to meet the standard RS-422, RS-423 requirements. The ST26C32 has an input sensitivity of 200mv over the common mode input voltage range of $\pm 7V$. To improve noise margin and output stability for slow changing input signal, special hysteresis is built in the ST26C32 circuit.

The ST26C32 is a high speed line receiver designed to operate with MFM / RLL controllers and hard disk drives as well as RS-422, and RS-423 differential applications. ST26C32 provides TTL compatible outputs to interface with standard 74LS and CMOS design environments. ST26C32 is suitable for low power 5V operation.

ORDERING INFORMATION

Part No.	Package	Operating Temperature Range
ST26C32CP16	16 Lead 300 Mil PDIP	0°C to +70°C
ST26C32CF16	16 Lead 150 Mil JEDEC SOIC	0°C to +70°C
ST26C32IP16	16 Lead 300 Mil PDIP	-40°C to +85°C
ST26C32IF16	16 Lead 150 Mil JEDEC SOIC	-40°C to +85°C

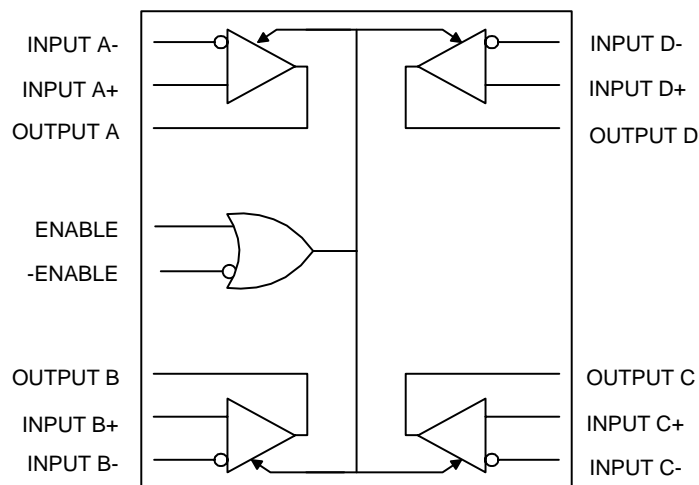
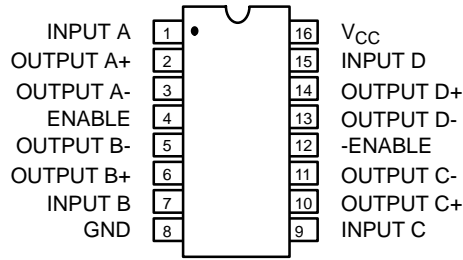
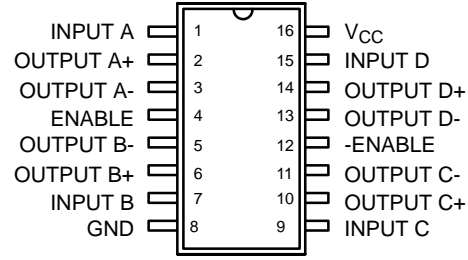

Figure 1. Block Diagram

PIN CONFIGURATION



16 Lead PDIP (0.300")



16 Lead SOIC (Jedec, 0.150")

PIN DESCRIPTION

Pin #	Symbol	Type	Description
1	INPUT A-	I	Receiver A differential inverting input pin.
2	INPUT A+	I	Receiver A differential non-inverting input pin.
3	OUTPUT A	O	Receiver A output pin.
4	ENABLE	I	Gate control (active high). This pin is one of the two control pins which enables or disables all four receivers.
5	OUTPUT B	O	Receiver B output pin.
6	INPUT B+	I	Receiver B differential non-inverting input pin.
7	INPUT B-	I	Receiver B differential inverting input pin.
8	GND	O	Signal and power ground.
9	INPUT C-	I	Receiver C differential inverting input pin.
10	INPUT C+	I	Receiver C differential non-inverting input pin.
11	OUTPUT C	O	Receiver C output pin.
12	-ENABLE	I	Gate control (active low). See ENABLE description
13	OUTPUT D	O	Receiver D output pin.
14	INPUT D+	I	Receiver D differential non-inverting input pin.
15	INPUT D-	I	Receiver D differential inverting input pin.
16	V _{CC}	I	Power supply pin.

AC ELECTRICAL CHARACTERISTICS

Test Conditions: $T_A = -40^{\circ}\text{C} - +85^{\circ}\text{C}$, $V_{CC} = 5.0\text{V} \pm 10\%$ unless otherwise specified.

Symbol	Parameter	Min.	Typ.	Max.	Unit	Conditions
T_1	Propagation Delay, Input to Output		8	10	ns	$S1=V_{CC}$
T_2	Propagation Delay, Input to Output		18	20	ns	$S1=GND$
T_3	Output Enable Time		18	20	ns	$V_{DIF}=2.5\text{V}$
T_4	Output Disable Time		18	20	ns	$V_{DIF}=2.5\text{V}$

DC ELECTRICAL CHARACTERISTICS

Test Conditions: $T_A = -40^{\circ}\text{C} - +85^{\circ}\text{C}$, $V_{CC} = 5.0\text{V} \pm 10\%$ unless otherwise specified.

Symbol	Parameter	Min.	Typ.	Max.	Unit	Conditions
V_{IH}	Enable High Level	2.0			V	
V_{IL}	Enable Low Level			0.8	V	
V_{OH}	Output High Level	3.8	4.2		V	$I_{OH} = -6\text{mA}$
V_{OL}	Output Low Level			0.4	V	$I_{OH} = 6\text{mA}$
V_{ID}	Differential Input Level	-0.2		0.2	V	$-7\text{V} < V_{CM} < +7\text{V}$
V_H	Input Hysteresis		50		mV	
I_{IN}	Input Current			± 1.0	μA	
I_{CC}	Operating Current		12		mA	$V_{DIF}=+1\text{V}$
I_{OZ}	Three-State Output Leakage		± 1.0	± 5.0	μA	$V_{OUT}=V_{CC}$ or GND
I_{EN}	Enable Input Current		± 1.0		μA	$V_{IN}=V_{CC}$ or GND
V_R	Input Resistance	5		15	$\text{K}\Omega$	$-7\text{V} < V_{CM} < +7\text{V}$

Specifications are subject to change without notice

ABSOLUTE MAXIMUM RATINGS

Supply Range 7V
 Voltage at Any Pin GND-0.3V to $V_{CC} + 0.3\text{V}$
 Operating Temperature -40°C to $+85^{\circ}\text{C}$

Storage Temperature -60°C to $+160^{\circ}\text{C}$
 Package Dissipation 500mW

Enable	-Enable	Input	Differential Non-Inverting Output	Differential Inverting Output
L	H	Z	X	X
H	L	L	L	H
H	L	H	H	L

Notes

X = Don't care

Z = Three-State (high impedance)

Table 1. Functional Table

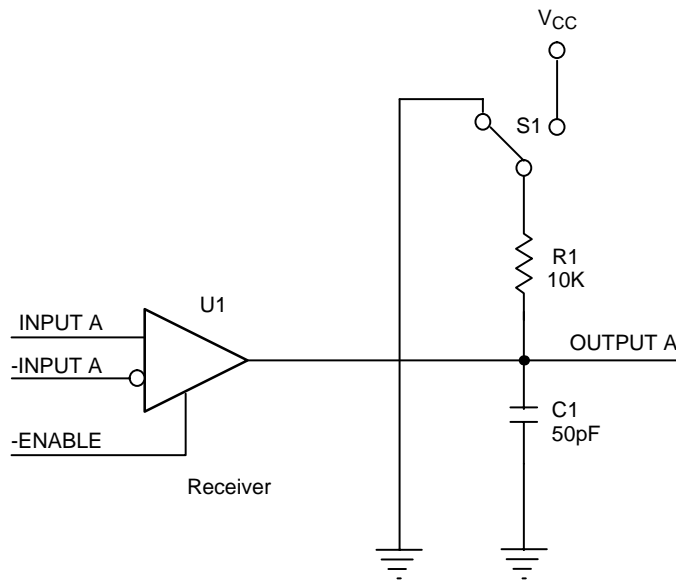

Figure 2. Test Condition

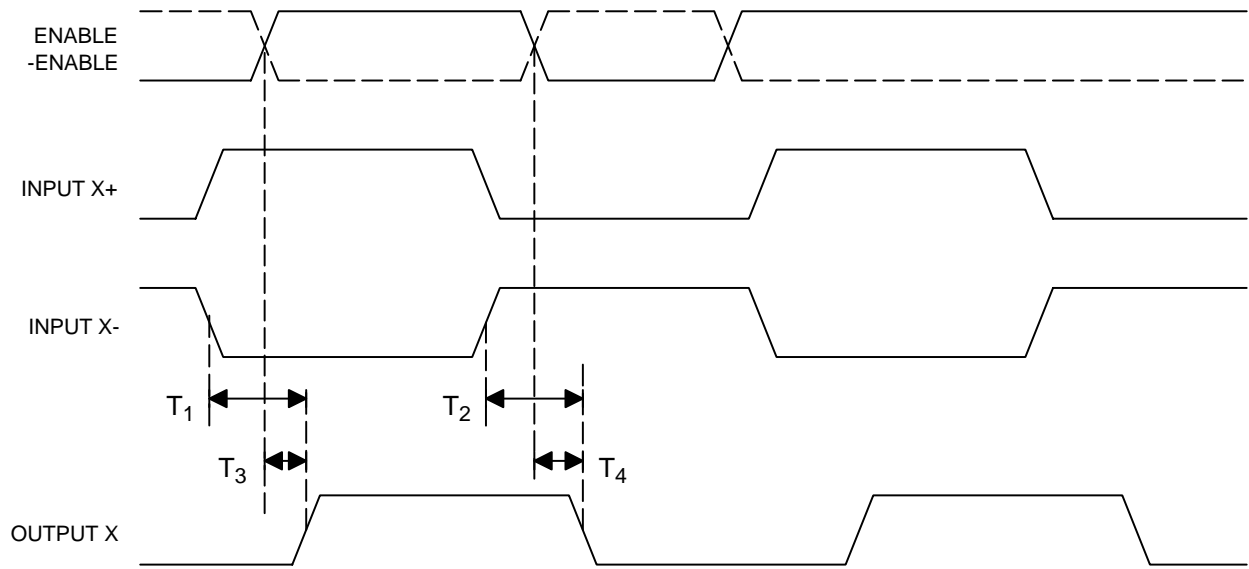
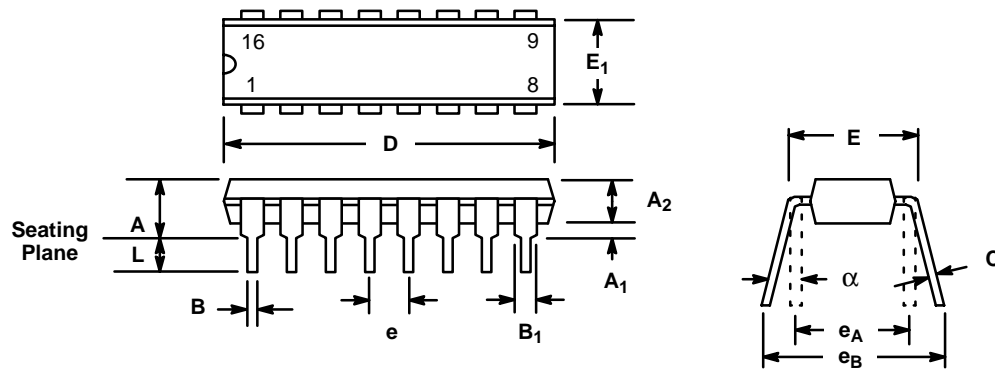

Figure 3. Differential Line Receiver Timing

16 LEAD PLASTIC DUAL-IN-LINE (300 MIL PDIP)

Rev. 1.00



SYMBOL	INCHES		MILLIMETERS	
	MIN	MAX	MIN	MAX
A	0.145	0.210	3.68	5.33
A ₁	0.015	0.070	0.38	1.78
A ₂	0.115	0.195	2.92	4.95
B	0.014	0.024	0.36	0.56
B ₁	0.030	0.070	0.76	1.78
C	0.008	0.014	0.20	0.38
D	0.745	0.840	18.92	21.34
E	0.300	0.325	7.62	8.26
E ₁	0.240	0.280	6.10	7.11
e	0.100 BSC		2.54 BSC	
e _A	0.300 BSC		7.62 BSC	
e _B	0.310	0.430	7.87	10.92
L	0.115	0.160	2.92	4.06
α	0°	15°	0°	15°

Note: The control dimension is the inch column

**16 LEAD SMALL OUTLINE
(150 MIL JEDEC SOIC)**

Rev. 1.00

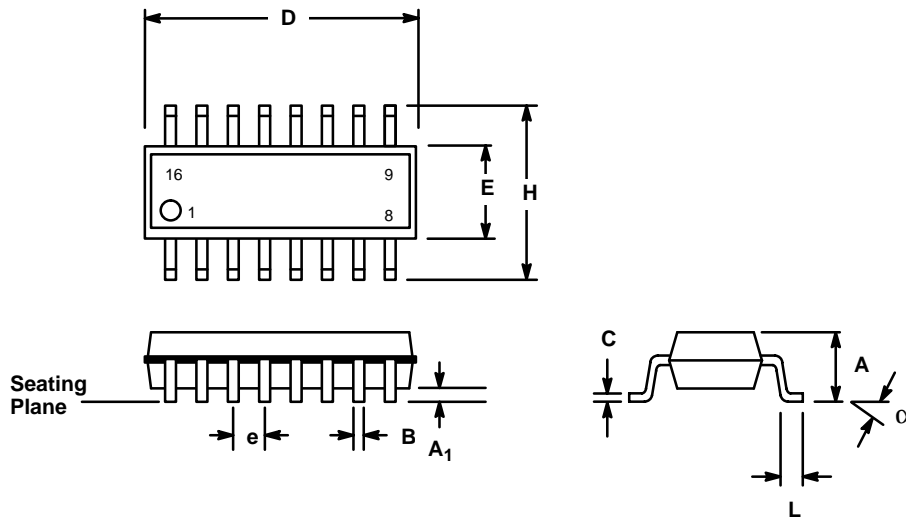

SYMBOL	INCHES		MILLIMETERS	
	MIN	MAX	MIN	MAX
A	0.053	0.069	1.35	1.75
A ₁	0.004	0.010	0.10	0.25
B	0.013	0.020	0.33	0.51
C	0.007	0.010	0.19	0.25
D	0.386	0.394	9.80	10.00
E	0.150	0.157	3.80	4.00
e	0.050 BSC		1.27 BSC	
H	0.228	0.244	5.80	6.20
L	0.016	0.050	0.40	1.27
α	0°	8°	0°	8°

Note: The control dimension is the millimeter column

NOTICE

EXAR Corporation reserves the right to make changes to the products contained in this publication in order to improve design, performance or reliability. EXAR Corporation assumes no responsibility for the use of any circuits described herein, conveys no license under any patent or other right, and makes no representation that the circuits are free of patent infringement. Charts and schedules contained here in are only for illustration purposes and may vary depending upon a user's specific application. While the information in this publication has been carefully checked; no responsibility, however, is assumed for inaccuracies.

EXAR Corporation does not recommend the use of any of its products in life support applications where the failure or malfunction of the product can reasonably be expected to cause failure of the life support system or to significantly affect its safety or effectiveness. Products are not authorized for use in such applications unless EXAR Corporation receives, in writing, assurances to its satisfaction that: (a) the risk of injury or damage has been minimized; (b) the user assumes all such risks; (c) potential liability of EXAR Corporation is adequately protected under the circumstances.

Copyright 1997 EXAR Corporation
Datasheet June 1997

Reproduction, in part or whole, without the prior written consent of EXAR Corporation is prohibited.