

FPT-120C-A01

<p>120-pin ceramic QFP</p>  <p>(FPT-120C-A01)</p>	Lead pitch	0.8 mm
	Lead shape	Gullwing
	Sealing method	Metal seal

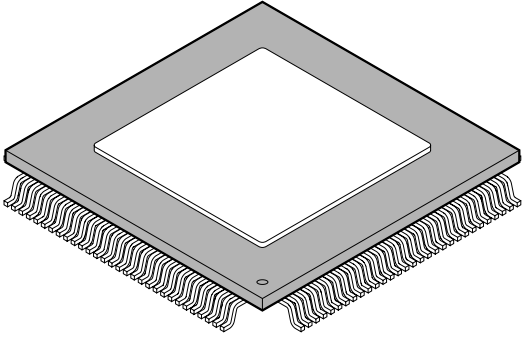
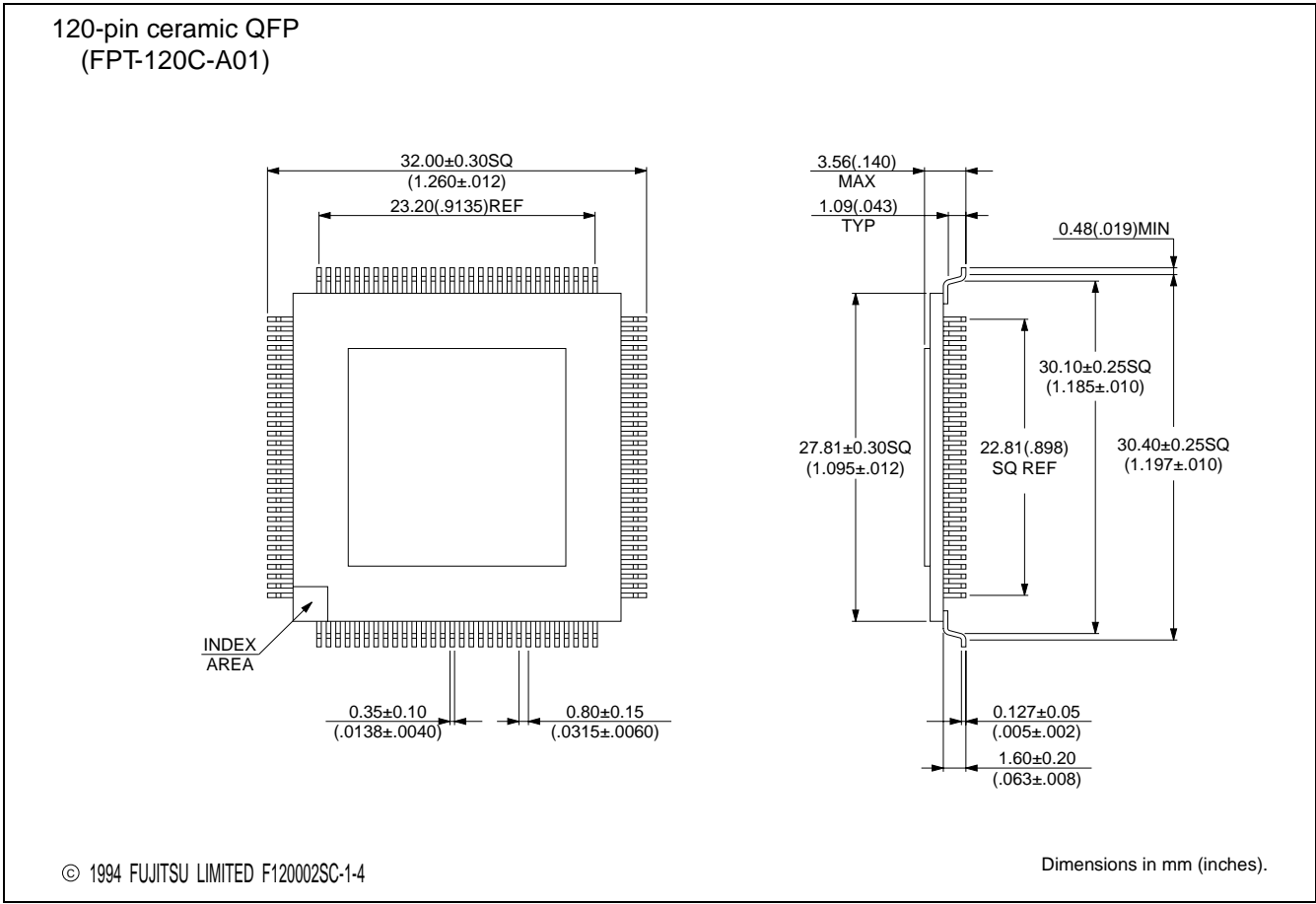

The contents of this document are subject to change without notice.
Customers are advised to consult with FUJITSU sales representatives before ordering.
FUJITSU is unable to assume responsibility for infringement of any patent rights or other rights of third parties arising from the use of the information or package dimensions in this document.