

FPT-120P-M21

EIAJ code : *P-LQFP-0120-1616-0.50

<p>120-pin plastic LQFP</p>  <p>(FPT-120P-M21)</p>	Lead pitch	0.50 mm
	Package width × package length	16.0 × 16.0 mm
	Lead shape	Gullwing
	Sealing method	Plastic mold
	Mounting height	1.70 mm MAX
	Weight	0.88 g

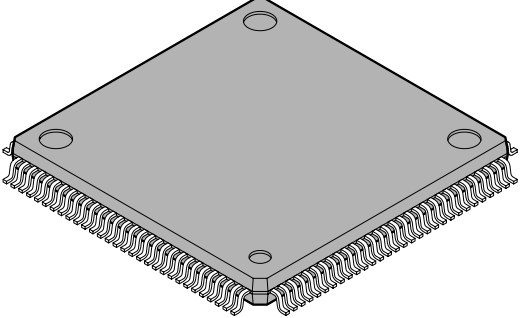
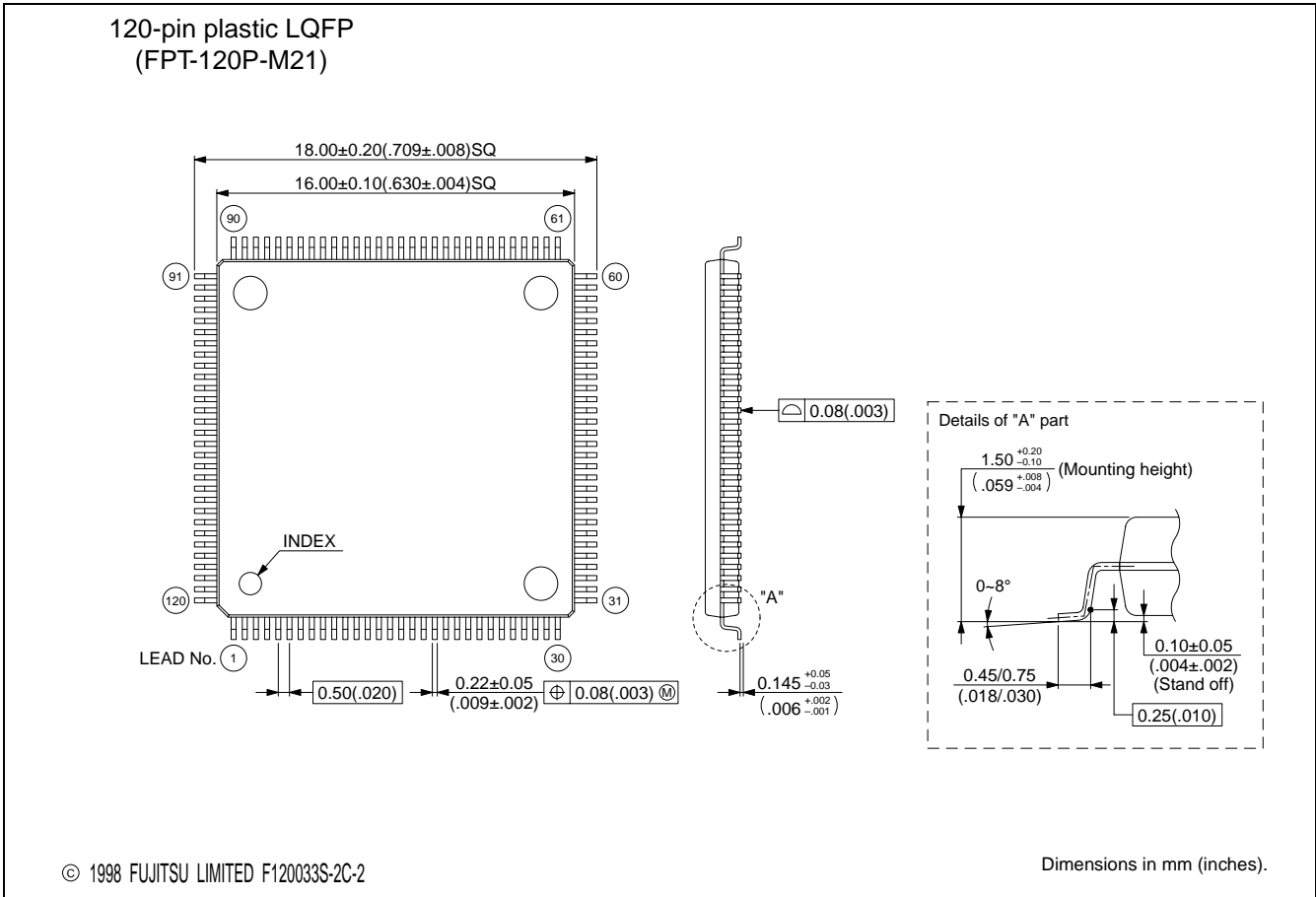

The contents of this document are subject to change without notice.
Customers are advised to consult with FUJITSU sales representatives before ordering.
FUJITSU is unable to assume responsibility for infringement of any patent rights or other rights of third parties arising from the use of the information or package dimensions in this document.