

FPT-144P-M01

EIAJ code : *QFP144-P-2828-1

<p>144-pin plastic QFP</p>  <p>(FPT-144P-M01)</p>	Lead pitch	0.65 mm	
	Package width × package length	28 × 28 mm	
	Lead shape	Gullwing	
	Sealing method	Plastic mold	

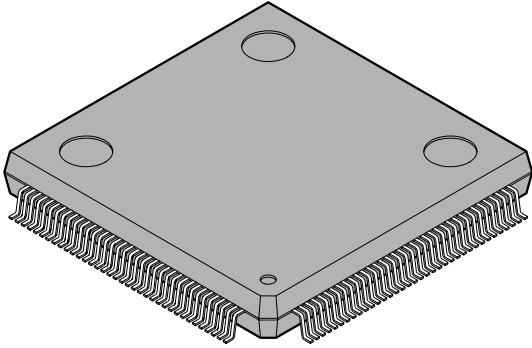
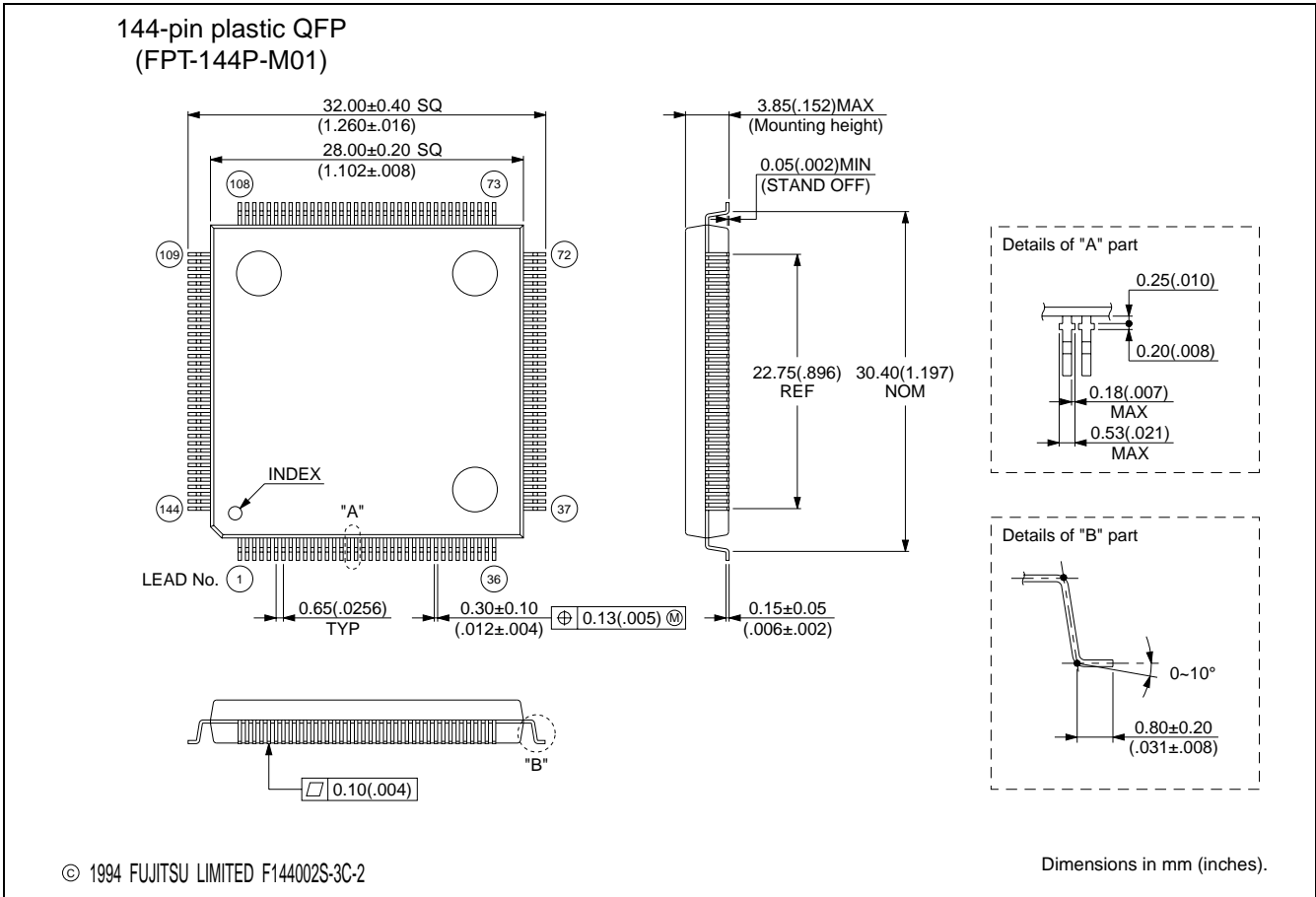

The contents of this document are subject to change without notice.
Customers are advised to consult with FUJITSU sales representatives before ordering.
FUJITSU is unable to assume responsibility for infringement of any patent rights or other rights of third parties arising from the use of the information or package dimensions in this document.