

QUAD FLAT L-LEADED PACKAGE 80 PIN CERAMIC

FPT-80C-A02

<p>80-pin ceramic QFP</p>  <p>(FPT-80C-A02)</p>	Lead pitch	0.8 mm	
	Lead shape	Gullwing	
	Sealing method	Metal seal	

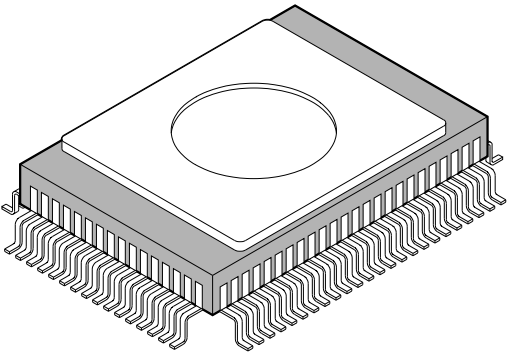