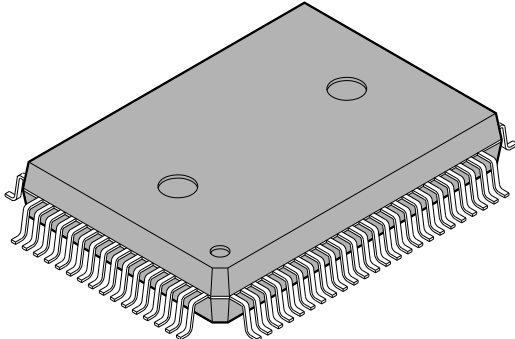

QUAD FLAT L-LEADED PACKAGE 80 PIN PLASTIC

FPT-80P-M06

EIAJ code : *QFP080-P-1420-4

<p>80-pin plastic QFP</p>  <p>(FPT-80P-M06)</p>	Lead pitch	0.80mm
	Package width × package length	14 × 20mm
	Lead shape	Gullwing
	Sealing method	Plastic mold
	Length of flat portion of pins	0.80mm

80-pin plastic QFP
(FPT-80P-M06)

