

LOW PROFILE SHRINK QUAD FLAT L-LEADED PACKAGE 80 PIN PLASTIC

FPT-80P-M11

EIAJ code : *QFP080-P-1414-1

<p>80-pin plastic LQFP</p>  <p>(FPT-80P-M11)</p>	Lead pitch	0.65mm	
	Package width × package length	14 × 14mm	
	Lead shape	Gullwing	
	Sealing method	Plastic mold	

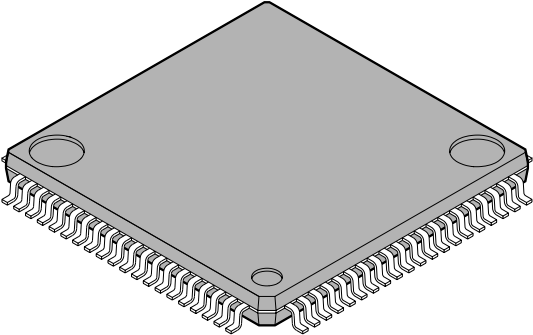