

MDS-168P-P39

<p>168-pin plastic DIMM (socket type)</p>  <p>(MDS-168P-P39)</p>	Lead pitch	1.27 mm	
	Motherboard material	Plastic	
	Mounted package material	Plastic	
	Pin plating	Gold	

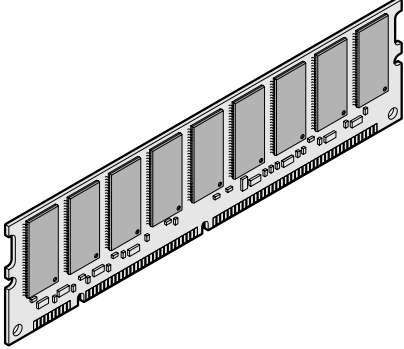
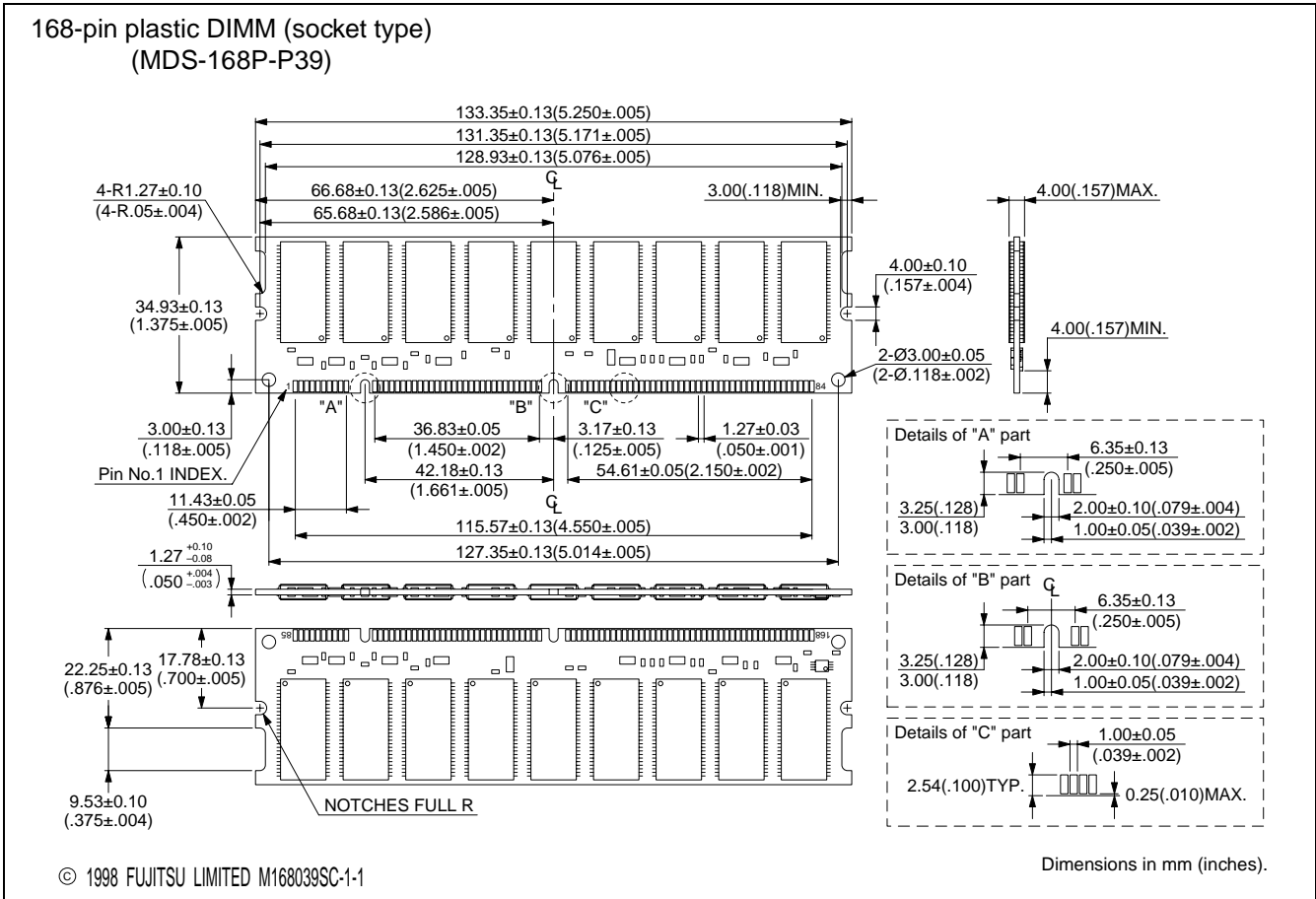

The contents of this document are subject to change without notice.
Customers are advised to consult with FUJITSU sales representatives before ordering.
FUJITSU is unable to assume responsibility for infringement of any patent rights or other rights of third parties arising from the use of the information or package dimensions in this document.