

AN1027

Reliability/Performance Aspects of CATV Amplifier Design

Prepared by
Michael D. McCombs

ABSTRACT

The reliability advantages to be offered by the RF hybrid amplifier as used in CATV applications are discussed. The active part of the hybrid amplifier is the transistor. Metallization, ballasting and ruggedness are reliability related factors that must be considered by the device engineer when designing a high performance CATV transistor. Vertical and horizontal geometry and device distortion mechanisms are performance related factors that must also be taken into account. The interrelation between these factors is examined. Life test data is then presented to illustrate the advantages to be gained by careful device design.

I. INTRODUCTION

The cable television system operator buys equipment which he knows has demonstrated a certain minimum level of performance, or in other words, equipment that meets his specifications. If he questions this performance he can run various electrical tests to check it.

Another question that we would like to be able to answer is, how long will his equipment operate before it fails, costing him downtime and repair. This is the question of reliability and to understand this it is necessary to understand the factors that go into designing for reliability.

The primary building block of a reliable CATV amplifier is the RF integrated circuit. This concept possesses many advantages over the PC board discrete design including a reduced number of interconnects and the ability of the manufacturer to effectively test the system before delivery to the equipment manufacturer.

Going one step further, the basic constituent of the integrated circuit is the transistor itself. It is in the design of this transistor that the ideals of high performance with reliability can be effectively realized.

The ultimate test is to see how long a part operates in the field without failing. The best way to simulate this is by means of a life test. Life test data is included as a means of demonstrating the results of a careful design.

II. WHAT IS RELIABILITY

One definition could be that reliability is something that can cost you money if you don't have it. The dictionary defines reliability as "the quality describing that which is dependable or honest." To build honest transistors and amplifiers is a noble concept but one which may be difficult to measure. So in the everyday sense, reliability is a somewhat abstract idea that is difficult to describe quantitatively. In engineering, however, reliability has an exact meaning.

"Reliability is the probability of a device performing its purpose adequately for the period of time intended under the operating conditions encountered."

When an amplifier is designed for a certain level of gain, it may happen in practice that the gain is less than that called out in the specification. In certain cases this may be acceptable if the amplifier turns out to be very reliable. However, another amplifier, which supplies the full gain with ease, may breakdown in operation because its components are being taxed to their limits. This is where reliability enters the picture. It is possible to achieve full performance and still have state-of-the-art reliability.⁵

We said that reliability is the capability of equipment not to break down in operation. The measure of an equipment's reliability, then, is the frequency at which failures occur in time. A failure is a malfunction which causes the component to violate the requirement for adequate performance. The frequency of such failures is called the failure rate. The reciprocal of the failure rate is called the mean time between failures or MTBF.

$$\lambda = \text{Failure Rate}$$
$$\frac{1}{\lambda} = \text{MTBF}$$



Referring to Figure 1, it is seen that there are three basic types of failures; early, chance and wearout failures.²

Early failures occur early in the life of a component and result usually from poor manufacturing. These can be eliminated by a 'burn-in' process.

Wearout failures are a symptom of component aging. These types of failures can be eliminated by either replacing at regular intervals or by designing for longer life than the intended life of the equipment if the components are inaccessible.

Chance failures occur at random intervals and are due to sudden stress accumulations beyond the design strength of the component. Since the other failure types are relatively easy to eliminate, performance reliability should be determined by the chance failures.

For chance failures only, reliability may be expressed by the exponential relationship

$$R(t) = e^{-\lambda t}$$

where λ is the failure rate and t is a given operating time; t must never exceed the 'useful life' of the device. The derivation of this reliability expression is found in the Appendix.

System failures are caused by component failures. When components can fail only because of chance, the system will fail only because of chance. The design engineer is responsible for the reliability which is characteristic of his equipment. If he desires to reduce the number of chance failures which occur during the useful life period of his equipment, he must keep several key points in mind.⁵

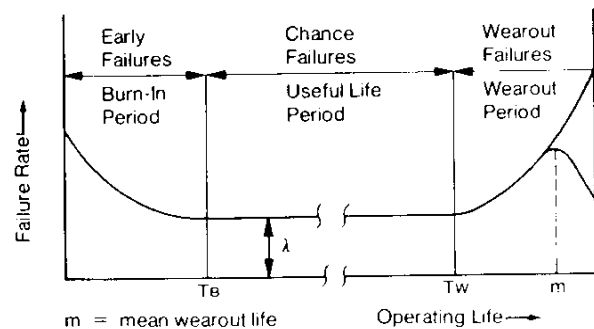

Figure 1. Component Failure Rate as a Function of Age

1. Design components to accept overstress; the normal operating point should be well below rated values, including temperature.
2. Provide good packaging with adequate heat sinking.
3. Design with as few components and interconnects as possible.

III. HYBRID CIRCUIT RELIABILITY ADVANTAGES

The hybrid circuit is the heart of the CATV amplifier. This assembly must perform its duty while experiencing a variety of electrical and environmental extremes. If the hybrid circuit should fail, then the cost to the system operator is high. For this reason the hybrid circuit should be an extremely reliable piece of equipment.

There are certain qualities of a hybrid circuit which make it an inherently reliable assembly.

One subtle advantage relates to the wear out life of components. Replacement of a hybrid circuit means replacing every amplifier component which resets the clock on the entire amplifier as far as mean life is concerned. Replacing a component in a discrete amplifier does not. All of the other discrete components continue to approach their wear out life.

The metallization system of the hybrid is another advantage. The gold metallization which is used for interconnects on the hybrid circuit allows the designer to have the high conductivity of gold for use in tying together the various components of the circuit, while having the additional reliability advantage of a mono-metallic gold system in wire bonding from the transistor to the hybrid. Even though the hybrid circuit utilizes heat sinking to reduce heat buildup, any bi-metallic interface will be susceptible to failure due to intermetallic formation. These gold-aluminum intermetallics are more brittle than the parent metals, and they also are susceptible to void formation due to the faster diffusion of aluminum into gold compared with gold into aluminum (Kirkendall Effect). If a hybrid circuit is manufactured using die with aluminum metallization, it is certainly preferable to use aluminum for bonding. This is because the gold-aluminum interface will then occur on the substrate, away from the heat of the transistor. This is important since the formation of intermetallics, $AuAl_2$ or Au_3Al_2 , is accelerated by temperature. However, these interfaces, even though they occur on the substrate, are nonetheless sensitive to weakening. Which intermetallic compound is formed depends on the amount of gold available in the bonding area. If the gold is thin then Au_3Al_2 will be formed. If the gold is thicker then $AuAl_2$ will be formed. The end result is the same; voiding and a weak bond which eventually lifts. The entire process can be accelerated by thermal cycling whereby cracks are formed in the brittle intermetallics.¹ Data presented later illustrates the comparison between failure rates due to bond lifts in aluminum and gold systems.

Another advantage which hybrids enjoy over discrete designs is the reduction of the number of interconnects.

An interconnect is a potential failure point. Reduction of the number of these points will result in a more reliable system. A calculation of the additional interconnects required in a typical discrete amplifier over the hybrid equivalent shows an increase of 127 interconnects in the discrete version.³ Figure 2 summarizes hybrid life test data.

So it is apparent that the hybrid structure is inherently more reliable than a discrete assembly. But the heart of the amplifier, be it hybrid or discrete, is the transistor.

Reliability Data at 95°C Case Temperature

Part Description	Unit Hours Accumulated	# Fail	MTBF With 90% Confidence	MTBF — Gain Product
Transistor Chip	7,398,000	3	141 Years	—
CA2200 Hybrid	984,000	4	13 Years	221dB — Yrs
CA2600 Hybrid	577,000	4	8 Years	264dB — Yrs

Figure 2. Hybrid Circuit Life Test Data

IV. RF TRANSISTOR DESIGN CONSIDERATIONS

The performance which can be obtained from the amplifier is determined, in the end, by the transistor. Not only must the transistor provide performance, however, it must provide this performance for a reasonable length of time. If the transistor fails, then the hybrid fails and cost to the system operator is the result.

When the transistor engineer begins to design a device for use in CATV amplifiers, then, he is faced with two main requirements. The device must offer a certain level of performance and it must do its job reliably. We will now investigate the RF transistor and the considerations that go into its design.

1. Starting Material

Modern transistors are built using what is called the planar technology. This name arises from the fact that all areas of the transistor are found on the planar surface of the silicon wafer. Figure 3 illustrates a cross-section

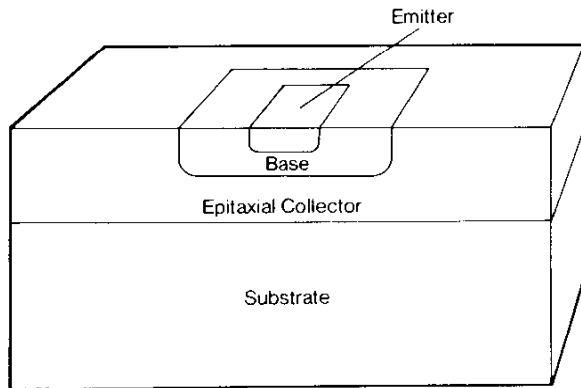

Figure 3. Planar-Epitaxial Technology

of a typical transistor structure as built using the planar technology. The first job of the designer is to decide what starting material he wishes to use for his transistor. The starting material consists of a wafer of silicon, approximately 10 mils thick and typically 2 inches in diameter. This silicon has been grown in crystal form while introducing a large concentration of impurities. This substrate silicon, then, is very heavily 'doped' so that the resistivity is very low. On the surface of this low resistivity silicon wafer is then grown a layer of silicon

which is not so heavily doped so that the resistivity of this layer is higher than that of the substrate. It is the configuration of this 'epitaxial layer' that is very important to the performance of the device. It is this layer that will form the collector of the transistor. There are two parameters of the epi layer that can be specified by the engineer. One is the thickness and the other is the resistivity. The resistivity is chosen from operating voltage considerations. The transistor is intended for a specific purpose and presumably the voltage at which it will be operating is known. If the device will be biased at 20 volts in an amplifier, then the collector breakdown voltage of the transistor, BVC_{EO} , should be higher than 20 volts to provide a safety cushion. The phenomenon that occurs in a well-designed transistor at breakdown is called avalanche. This occurs when a sufficiently high reverse voltage is placed across a p-n junction. A field is formed across this junction and carriers are accelerated across the field. When the applied voltage equals the avalanche voltage a multiplication effect occurs in which atomic bonds are broken and the junction breaks down. This is the collector breakdown voltage and it is proportional inversely to the doping level of the collector or epi layer. By specifying epi material, then, the designer sets his voltage operating limit.

The other epi parameter of interest is the thickness of the layer. It has been found that epi thickness is closely tied in to both device reliability and performance. One parameter that is commonly used to describe high-frequency transistors is f_T . This is the gain-bandwidth product of the device or the frequency at which the common-emitter, short circuit current gain, h_{21} , equals unity. A high f_T means to the circuit designer better wide band gain performance. The f_T frequency can be related to the physical device in terms of the various delay times throughout the transistor. If the delay that a carrier sees in traveling through a device is less than in another device, then the f_T for the device with the least delay is higher. The thickness of the epitaxial region is related directly to one of these delay times; namely the $r_{sc}C_{TC}$ time constant in the collector. The r_{sc} is the collector series resistance and to reduce this value for a given resistivity, we must reduce the epi thickness. There is another advantage to be gained from reducing the epi thickness which relates to distortion performance. Figure 4 shows a comparison of intermodulation distortion performance between two CATV transistors. The transistors are identical in all respects except that one

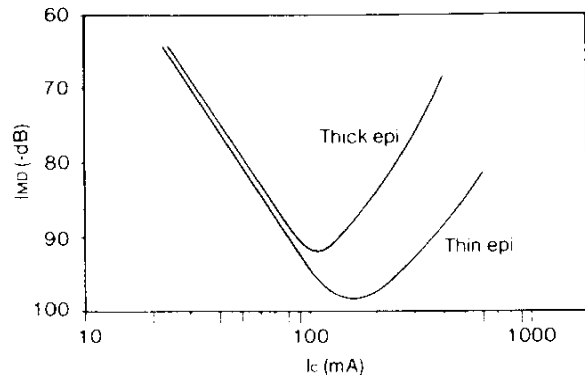

Figure 4. IMD Distortion Performance as a Function of EPI Thickness

device was built on epi material which was 50% thicker than the other. It is seen that the device which was built on thin epi material offers better distortion performance at higher current levels. The reason for this performance gain with thin epi is the fact that the maximum current density available in a device increases as the epi thickness is decreased. This occurs because of debiasing of the collector-base depletion region by the resistive epi region. The thin epi device, then, acts like a larger device at higher currents, resulting in better distortion performance at these higher levels.

Thin epitaxial material appears to yield very good transistors for CATV applications. Unfortunately there is a negative side to the story. The fact is that as the epi material is made thinner and thinner to achieve good performance the transistor becomes more and more sensitive to voltage variations. With thin epi the ballasting effect of the collector resistor is lost and the transistor loses ruggedness. The designer, then, wants to choose an epitaxial material which is as thin as possible for performance yet which is thick enough to avoid complete depletion and provide some collector ballasting.

2. Vertical Geometry

Once the starting material is decided upon, then it must be insured that a process is available which will yield a high performance vertical geometry. The importance of high f_T in the CATV transistor has been discussed. Another time constant which can be reduced in order to increase f_T is the delay due to carrier movement through the base region. The relationship for this delay is

$$t_b = \frac{W_b^2}{2.43 D_{eb} \nabla n (N_b' / N_{bc})}$$

This relationship describes the time required for carrier transit across the base region in terms of base width, W_b ; diffusion co-efficient, D_{eb} ; and doping gradient, N_b' and N_{bc} . The point here is that this delay time varies directly as the square of the base width. A desirable goal then is to produce a transistor which has a narrow base width. The well understood diffusion process can be used to control this parameter to a point. However, as narrower base widths are sought, device yields go down due to non-uniformities which are inherent in the diffusion process. State-of-the-art base widths with good uniformity are possible, though, by taking advantage of ion implant technology for the formation of the device junctions. Another advantage of implantation is that it makes possible steeper gradients in the emitter and base regions resulting in higher fields and shorter transit times in those areas.

3. Horizontal Geometry

One more item must be considered before the CATV transistor is ready to be built. A mask set must be designed, or, in other words, it must be determined what the device will look like, physically.

First, the basic device configuration must be decided upon. There are three transistor contact geometries in use: these are interdigitated, overlay, and mesh. The

overlay and mesh configurations are used primarily for modern power transistors. High frequency devices are sensitive to parasitic capacitances and this favors the interdigitated design.

Figure 5 is a representation of typical transistor configurations. The base area is dictated by the power

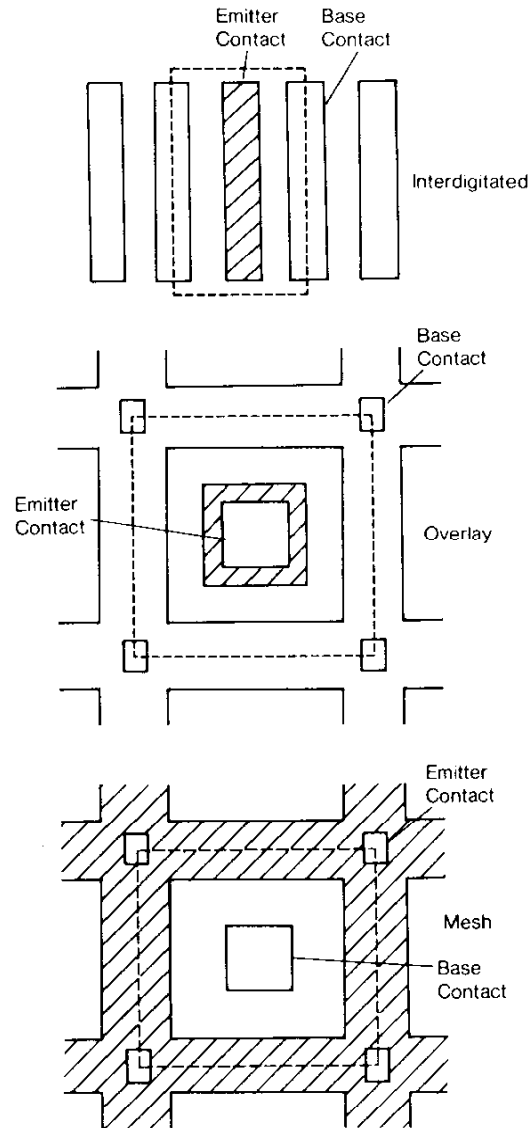

Figure 5. Typical Transistor Configurations

handling requirements of the transistor. There must be enough area available to dissipate the heat which is generated. The amount of current to be handled by the device will determine what the minimum emitter periphery is. This is because at higher bias levels and frequencies a large transverse voltage drop occurs in the active base region under the emitter. This will have a de-biasing effect on the central portion of the emitter-base junction causing most of the current to pass at the emitter edges. Since it is known how much current the

device will be required to handle, it is possible to calculate the amount of emitter periphery necessary to safely handle this current. The task now is to pack this amount of emitter periphery into the smallest base area possible, thereby reducing collector-base junction capacitance. Two examples of possible interdigitated designs having equal emitter peripheries are shown in Figure 6. It is seen

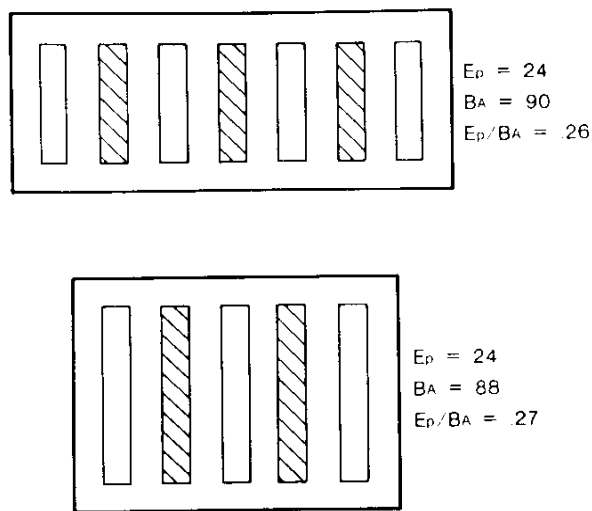

Figure 6. E_p/BA Comparison for Square vs Rectangular Base Configuration

that slightly higher E_p/BA ratios are possible with a design which is square compared to one with a higher aspect ratio. The problem with the square configuration is that the long emitter fingers required will result in considerable voltage drop along their length. The result is that part of the device is not being used and hot spots will develop. Not only will device performance be reduced, but it will soon fail because of overheating. The design with the higher aspect-ratio is desirable since the voltage drop problem is eliminated. Another advantage of this configuration is that it is inherently better able to dissipate heat since the cells are not so closely coupled as in the square configuration. This design also has a problem, however. Although the emitter fingers are now short enough, the active area of the device is now quite long. The middle portion of the device will tend to draw more current which is not efficient. The solution to this problem is to add ballast resistors between the emitter feeder arm and the emitter fingers. (See Figure 7.) The ballast resistors are thus in series with the emitter contact metallization. If an emitter-base junction site begins pulling more than its share of current the series resistance will cause a proportionate drop in the input voltage for that site, thus limiting the current and preventing failure. An important point is the type of ballast resistor used. Two types of resistor are popular, thin film or diffused. Thin film resistors are susceptible to microcracking and they also are faced with a high

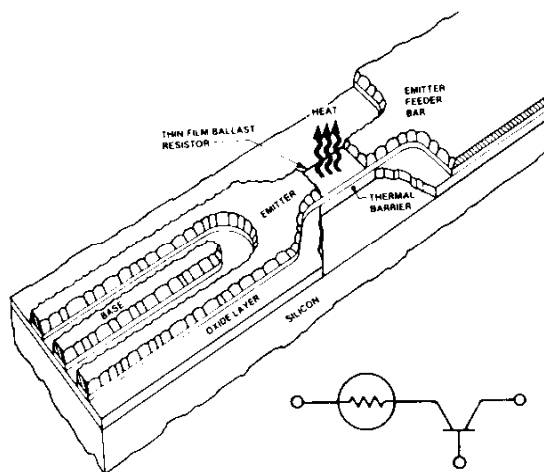
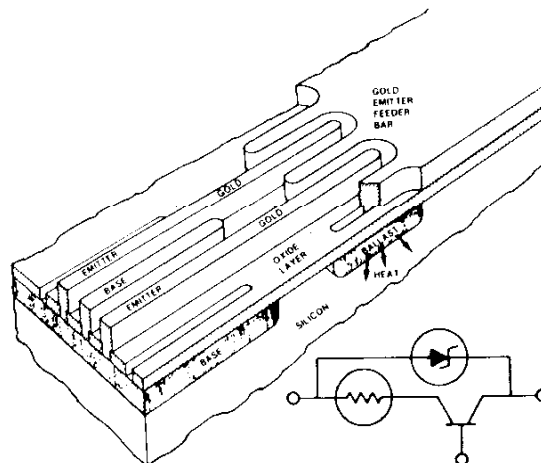

Figure 7. Ballast Resistor Configurations

thermal barrier since they sit on top of the silicon dioxide barrier. Diffused resistors are more reliable since they avoid the oxide barrier and are not susceptible to cracking.

It is also desirable to reduce the contact spacing and the emitter contact widths of the transistor for two important reasons.¹ A narrow contact spacing will allow more emitter periphery to be placed within a given base area. This is good since we have seen that gain performance depends directly on the amount of periphery available for current handling. A narrow emitter stripe is desirable since the resistance of the base region, r_b^i , varies directly as the emitter contact width and it is necessary to reduce the parasitic r_b^i as much as possible for gain purposes. Incidentally, reduction of r_b^i is good for noise figure too. Figure 8 illustrates the impact of emitter width on base resistance.

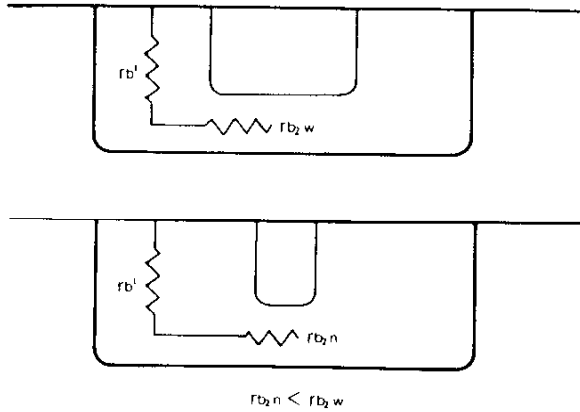

Figure 8. Effect of Emitter Stripe Width on Base Resistance

The last step in the construction of the transistor is the deposition of metallization so that contact can be made to the emitter and base regions. (See Figure 9.) The type

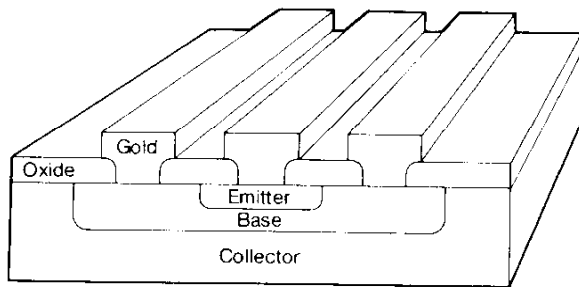

Figure 9. Transistor Metallization

of metal to be used is an important decision. The two metals that are low enough in conductivity that can be used for transistor metallization are gold and aluminum. Aluminum metallization has been used for years as a conductor for transistors. Its advantages are that it is a well-understood process, it offers a good silicon contact without any barrier metallization, and it is inexpensive. However, considering the micron contact geometry of the RF transistor and the fact that it will be mounted on a gold hybrid circuit, then the decision is considerably easier to make. For a CATV transistor, gold provides the following advantages over aluminum.⁴

1. Monometallic wire bonding system
 2. Electromigration resistance.
 3. Low contact resistance with elimination of shorts due to silicon-metal alloying
 4. Corrosion resistance.
 5. Oxide step coverage.
- Allows use of tighter contact geometries

Monometallic Wire Bonding System

As has been described, it is desirable to have an all-gold metal system for reasons of reliability. A monometallic system eliminates the formation of gold-aluminum inter-

metallics and the wire bond failures that result. Figure 10 illustrates life test data that shows an increased failure rate due to bond failures in the aluminum-gold system.

Life Test at 95°C Case Temperature

Part Description	Unit Hours Accumulated	Wire Bond Failure No's	Wire Bond Failure Rate %
601B, 200 Hybrids With Aluminum 3070 Die	1,162,000	24	4.1
2200, 2600 Hybrids With Gold 3040 Die	1,188,000	0	0

Figure 10. Wire Bond Failure Rates in Aluminum/Gold Life Test

Electromigration Resistance

It was shown earlier that it was desirable to achieve a high E_p/BA ratio so as to obtain maximum performance from a device. This was achieved by placing the transistor contacts as close together as possible. The use of such tight contact geometry forces the use of very narrow metal fingers. The resulting high current densities can lead to reliability problems as a result of electromigration. Electromigration is a phenomenon which occurs in metal films as a function of time, temperature, and current density. For any given temperature, a certain equilibrium concentration of vacancies exists in all metal films. Self diffusion of metal ions throughout the film arise due to the metal ions being thermally activated into adjacent vacancies. In the absence of any external forces, the metal ion diffusion will be isotropic and will result in no net accumulation or depletion of mass in any given site. In the presence of an electric field, however, the metal ions experience a force due to their charge, inducing an ionic flux toward the cathode end of the film. In addition, the conduction flow of electrons in the metal due to the electric field will cause electron scattering off the activated ions and impart momentum to them inducing an ionic flux toward the anodic end of the film. In good conductors, the momentum exchange force dominates the electrostatic force and results in a net mass transport toward the anodic end of the film. The result is an open circuit in the metallization strip. This void formation is accelerated by high temperatures and current density.⁶

Aluminum has exhibited a high susceptibility to electromigration for current densities above 10^{10} A/cm². Such a current density is easily realized in state-of-the-art RF devices. For a given device geometry there are only two alternatives to allow reduction of the current density in a device. Either the operating level can be reduced or a metal can be selected which has a higher mass and activation energy. The operating level cannot be reduced without a sacrifice in performance. We can still keep high performance and reduce the current density by using gold metallization. At 200°C, experiments conducted on identical transistors with gold vs. aluminum metallization showed an improvement in mean life time of two orders of magnitude using gold.

Contact Resistance

Gold cannot be used as a single layer metallization because of its relatively low silicon eutectic temperature and its poor adhesion to silicon and silicon dioxide. A barrier layer must be employed to prevent gold diffusion into the silicon and this barrier metal must offer good adhesion to silicon, silicon dioxide, and gold. Such a barrier is offered by a system utilizing platinum silicide, titanium and tungsten. The platinum silicide forms a good ohmic contact with the silicon; the Ti/W provides the necessary diffusion barrier and offers good adhesion to SiO₂ and silicon.

Aluminum has historically offered good ohmic contact without the need for barrier metals. In RF devices, however, at current densities well below electromigration densities, a problem of formation of silicon/aluminum alloy is ever present resulting in emitter-base shorts. Any hot spot formation will result in an increased alloying rate and early failure.

Corrosion Resistance

Under biased conditions, in a humid atmosphere, gold has demonstrated a lifetime more than 3 times that of aluminum. The failure mode in aluminum is electro-mechanical corrosion and gold is insensitive to this phenomenon.

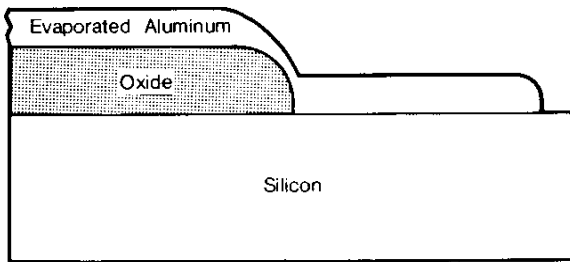

Step Coverage

Gold offers tremendous improvements over aluminum in its ability to cover oxide steps without decrease in metal thickness or cracking. (See Figure 11.) Aluminum is deposited by means of evaporation in a vacuum where the mean free path of the aluminum particle is long. This means that equal coverage of all surfaces is impossible even if the target is rotated during evaporation. The plate-up gold system reduces step coverage problems to insignificance.

Narrow Contact Geometries

The RF transistor must have very fine horizontal geometry to achieve the performance required in a CATV system. With aluminum metallization these narrow finger widths are achieved by etching the aluminum to remove it. Such a process, if done very carefully, will at best result in fingers of uneven width which are susceptible to high current densities and the associated reliability problems. The gold system is capable of providing microwave geometries with insignificant variations in line widths. In fact, the geometry on present gold CATV devices is narrower than some low-noise microwave devices which are on the market today.

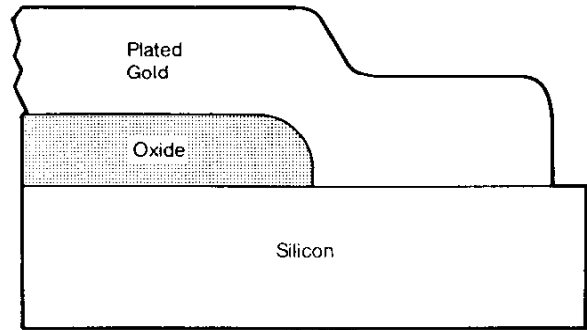

Figure 11. Oxide Step Coverage

V. SUMMARY

- 1 The CATV system operator is interested in performance with reliability in the amplifier equipment he uses
- 2 The basic building block of the CATV amplifier is the hybrid circuit. The hybrid amplifier offers reliability advantages over discrete designs including gold circuit metallization and a reduced number of interconnects
- 3 The heart of the hybrid circuit is the RF transistor
- 4 The design of a reliable transistor for use in CATV amplifiers requires a knowledge of basic design values plus the availability of state-of-the-art processing. Points to be considered include
 - starting material
 - vertical geometry
 - horizontal geometry
 - configuration
 - metallization.
- 5 Life tests show the improvements in reliability to be gained by careful transistor design

APPENDIX

Derivation of reliability expression for chance failures'

$$R(t) = e^{-\lambda t}$$

If an original population of X_0 items is continuously decaying so that there are X items at time t , the change of population in one interval dt is dX/dt . Divided by the total population X at t , this gives the negative rate at which the population changes at time t

$$-\lambda = \frac{dX}{dt} \cdot \frac{1}{X} = \frac{dX}{X dt}$$

then,

$$\lambda dt = -\frac{dX}{X}$$

Integrating over the time period being considered

$$\int_0^t \lambda dt = \ln X_0 - \ln X = \ln \frac{X_0}{X}$$

for $t = 0$, $X = X_0$

Then $C = X_0$

$$\text{And } X/X_0 = e^{-\int_0^t \lambda dt}$$

If the rate of decay λ is constant, then

$$X/X_0 = e^{-\lambda t}$$

Since X/X_0 is probability of survival for a decaying population then

$$R(t) = X/X_0 = e^{-\lambda t}$$

REFERENCES

- 1 Mike Flahie, "Reliability and MTF — The Long and Short of It," *Microwaves*, July 1972
- 2 James Humphrey and George Luettgenau, "Reliability Considerations in Design and Use of RF Integrated Circuits," IEEE/NCTE Conference, February 1976
- 3 Elliott Philofsky, "Design Limits When Using Gold-Aluminum Bonds," Motorola, Inc., Semiconductor Products Division
- 4 R. Flahie and M. Weiss, "A Study of the Advantages of Gold Metallization in the Manufacture of Microwave Transistors," TRW Semiconductors Technical Note
- 5 Igor Bazousky, *Reliability Theory and Practice*, Prentice-Hall, 1961
- 6 J. R. Black, "Electromigration Failure Modes in Aluminum Metallization for Semiconductor Devices," *Proceedings of the IEEE*, Volume 57, Number 9, September 1969

Motorola reserves the right to make changes without further notice to any products herein. Motorola makes no warranty, representation or guarantee regarding the suitability of its products for any particular purpose, nor does Motorola assume any liability arising out of the application or use of any product or circuit, and specifically disclaims any and all liability, including without limitation consequential or incidental damages. "Typical" parameters can and do vary in different applications. All operating parameters, including "Typicals" must be validated for each customer application by customer's technical experts. Motorola does not convey any license under its patent rights nor the rights of others. Motorola products are not designed, intended, or authorized for use as components in systems intended for surgical implant into the body, or other applications intended to support or sustain life, or for any other application in which the failure of the Motorola product could create a situation where personal injury or death may occur. Should Buyer purchase or use Motorola products for any such unintended or unauthorized application, Buyer shall indemnify and hold Motorola and its officers, employees, subsidiaries, affiliates, and distributors harmless against all claims, costs, damages, and expenses, and reasonable attorney fees arising out of, directly or indirectly, any claim of personal injury or death associated with such unintended or unauthorized use, even if such claim alleges that Motorola was negligent regarding the design or manufacture of the part. Motorola and  are registered trademarks of Motorola, Inc. Motorola, Inc. is an Equal Opportunity/Affirmative Action Employer.

Literature Distribution Centers:

USA: Motorola Literature Distribution; P.O. Box 20912; Phoenix, Arizona 85036.

EUROPE: Motorola Ltd.; European Literature Centre; 88 Tanners Drive, Blakelands, Milton Keynes, MK14 5BP, England.

JAPAN: Nippon Motorola Ltd.; 4-32-1, Nishi-Gotanda, Shinagawa-ku, Tokyo 141 Japan.

ASIA-PACIFIC: Motorola Semiconductors H.K. Ltd.; Silicon Harbour Center, No. 2 Dai King Street, Tai Po Industrial Estate, Tai Po, N.T., Hong Kong.



MOTOROLA