

# AN1518

## Using a Pulse Width Modulated Output with Semiconductor Pressure Sensors

Prepared by: Eric Jacobsen and Jeff Baum  
Sensor Design and Applications Group, Motorola Phoenix, AZ

### INTRODUCTION

For remote sensing and noisy environment applications, a frequency modulated (FM) or pulse width modulated (PWM) output is more desirable than an analog voltage. FM and PWM outputs inherently have better noise immunity for these types of applications. Generally, FM outputs are more widely accepted than PWM outputs, because PWM outputs are restricted to a fixed frequency. However, obtaining a stable FM output is difficult to achieve without expensive, complex circuitry.

With either an FM or PWM output, a microcontroller can be used to detect edge transitions to translate the time-domain signal into a digital representation of the analog voltage signal. In conventional voltage-to-frequency (V/F) conversions, a voltage-controlled oscillator (VCO) may be used in conjunction with a microcontroller. This use of two time bases, one analog and one digital, can create additional inaccuracies. With either FM or PWM outputs, the microcontroller is only concerned with detecting edge transitions. If a programmable frequency, stable PWM output

could be obtained with simple, inexpensive circuitry, a PWM output would be a cost-effective solution for noisy environment/remote sensing applications while incorporating the advantages of frequency outputs.

The Pulse Width Modulated Output Pressure Sensor design (Figure 1) utilizes simple, inexpensive circuitry to create an output waveform with a duty cycle that is linear to the applied pressure. Combining this circuitry with a single digital time base to create and measure the PWM signal, results in a stable, accurate output. Two additional advantages of this design are 1) an A/D converter is not required, and 2) since the PWM output calibration is controlled entirely by software, circuit-to-circuit variations due to component tolerances can be nullified.

The PWM Output Sensor system consists of a Motorola MPX5000 series pressure sensor, a ramp generator (transistor switch, constant current source, and capacitor), a comparator, and an MC68HC05P9 microcontroller. These subsystems are explained in detail below.

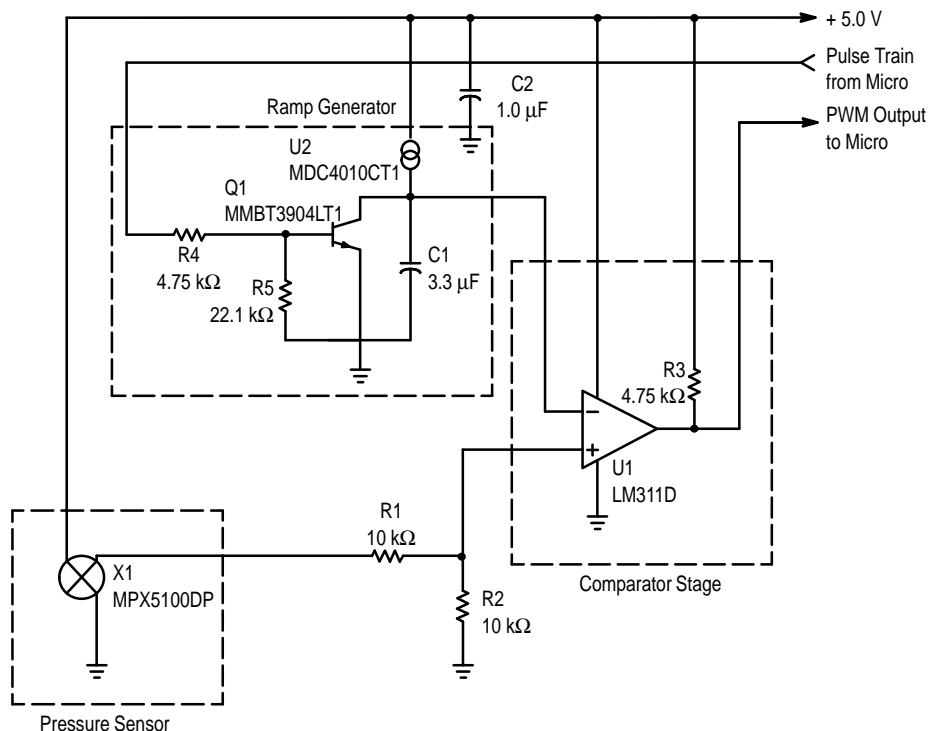

Figure 1. PWM Output Pressure Sensor Schematic

REV 1

## PRESSURE SENSOR

Motorola's MPX5000 series sensors are signal conditioned (amplified), temperature compensated and calibrated (i.e., offset and full-scale span are precision trimmed) pressure transducers. These sensors are available in full-scale pressure ranges of 50 kPa (7.3 psi) and 100 kPa (14.7 psi). With the recommended 5.0 V supply, the MPX5000 series

produces an output of 0.5 V at zero pressure to 4.5 V at full scale pressure. Referring to the schematic of the system in Figure 1, note that the output of the pressure sensor is attenuated to one-half of its value by the resistor divider comprised of resistors R1 and R2. This yields a span of 2.0 V ranging from 0.25 V to 2.25 V at the non-inverting terminal of the comparator. Table 1 shows the electrical characteristics of the MPX5100.

Table 1. MPX5100DP Electrical Characteristics

Characteristic	Symbol	Min	Typ	Max	Unit
Pressure Range	P <sub>OP</sub>	0	—	100	kPa
Supply Voltage	V <sub>S</sub>	—	5.0	6.0	Vdc
Full Scale Span	V <sub>FSS</sub>	3.9	4.0	4.1	V
Zero Pressure Offset	V <sub>off</sub>	0.4	0.5	0.6	V
Sensitivity	S	—	40	—	mV/kPa
Linearity	—	-0.5	—	0.5	%FSS
Temperature Effect on Span	—	-1.0	—	1.0	%FSS
Temperature Effect on Offset	—	-50	0.2	50	mV

## THE RAMP GENERATOR

The ramp generator is shown in the schematic in Figure 1. A pulse train output from a microcontroller drives the ramp generator at the base of transistor Q1. This pulse can be accurately controlled in frequency as well as pulse duration via software (to be explained in the microcontroller section).

The ramp generator uses a constant current source to charge the capacitor. It is imperative to remember that this current source generates a stable current only when it has approximately 2.5 V or more across it. With less voltage across the current source, insufficient voltage will cause the current to fluctuate more than desired; thus, a design constraint for the ramp generator will dictate that the capacitor can be charged to only approximately 2.5 V, when using a 5.0 V supply.

The constant current charges the capacitor linearly by the following equation:

$$\Delta V = \frac{I\Delta t}{C} \quad (1)$$

where  $\Delta t$  is the capacitor's charging time and C is the capacitance.

Referring to Figure 2, when the pulse train sent by the microcontroller is low, the transistor is off, and the current source charges the capacitor linearly. When the pulse sent by the microcontroller is high, the transistor turns on into saturation, discharging the capacitor. The duration of the high part of the pulse train determines how long the capacitor discharges, and thus to what voltage it discharges. This is how the dc offset of the ramp waveform may be accurately controlled. Since the transistor saturates at approximately 60 mV, very little offset is needed to keep the capacitor from discharging completely.

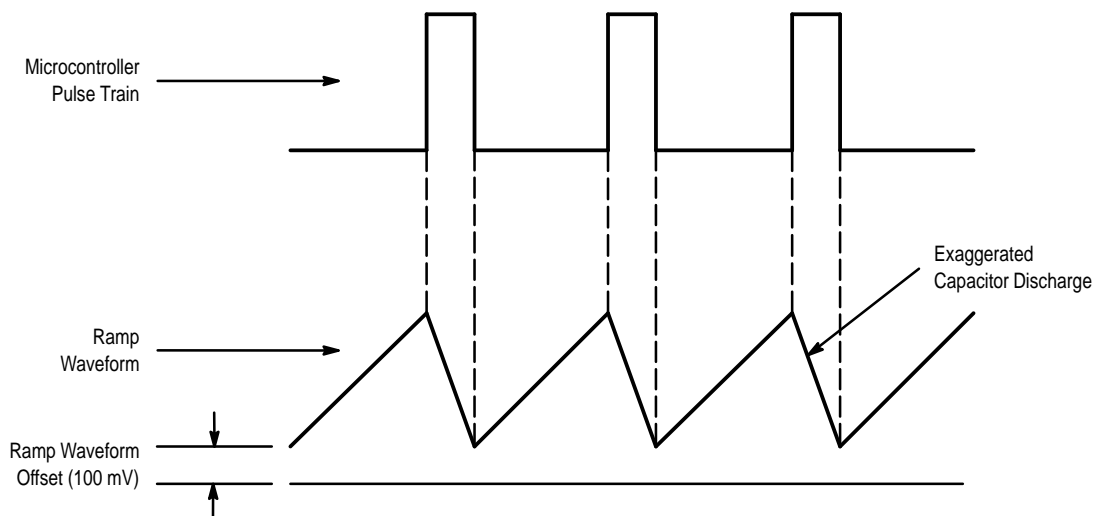

Figure 2. Ideal Ramp Waveform for the PWM Output Pressure Sensor

The PWM output is most linear when the ramp waveform's period consists mostly of the rising voltage edge (see Figure 2). If the capacitor were allowed to completely discharge (see Figure 3), a flat line at approximately 60 mV would separate the ramps, and these "flat spots" may result in

non-linearities of the resultant PWM output (after comparing it to the sensor voltage). Thus, the best ramp waveform is produced when one ramp cycle begins immediately after another, and a slight dc offset disallows the capacitor from discharging completely.

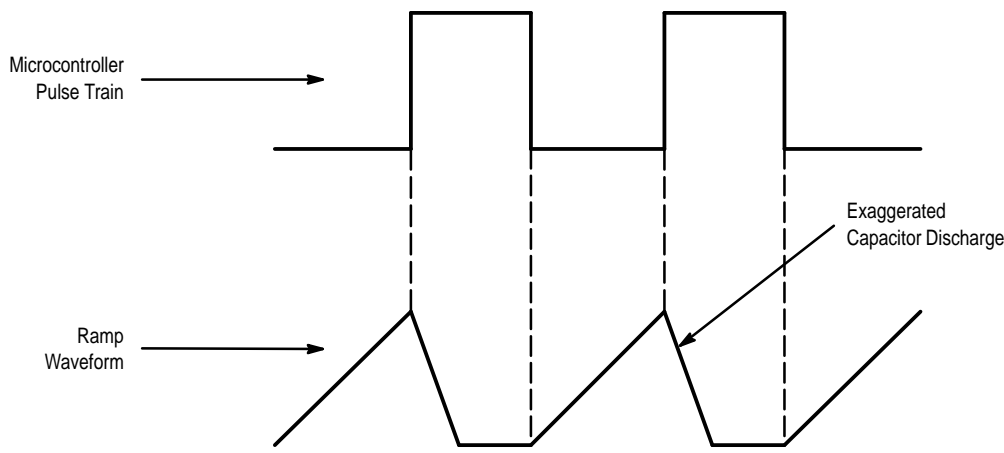

Figure 3. Non Ideal Ramp Waveform for the PWM Output Pressure Sensor

The flexibility of frequency control of the ramp waveform via the pulse train sent from the microcontroller allows a programmable-frequency PWM output. Using Equation 1 the frequency (inverse of period) can be calculated with a given capacitor so that the capacitor charges to a maximum  $\Delta V$  of approximately 2.5 V (remember that the current source needs approximately 2.5 V across it to output a stable current). The importance of software control becomes evident here since the selected capacitor may have a tolerance of  $\pm 20\%$ . By adjusting the frequency and positive width of the pulse train, the desired ramp requirements are readily obtainable; thus, nullifying the effects of component variances.

For this design, the ramp spans approximately 2.4 V from 0.1 V to 2.5 V. At this voltage span, the current source is stable and results in a linear ramp. This ramp span was used for reasons which will become clear in the next section.

In summary, complete control of the ramp is achieved by the following adjustments of the microcontroller-created pulse train:

- Increase Frequency: Span of ramp decreases. The dc offset decreases slightly.
- Decrease Frequency: Span of ramp increases. The dc offset increases slightly.
- Increase Pulse Width: The dc offset decreases. Span decreases slightly.
- Decrease Pulse Width: The dc offset increases. Span increases slightly.

## THE COMPARATOR STAGE

The LM311 chip is designed specifically for use as a comparator and thus has short delay times, high slew rate, and an open-collector output. A pull-up resistor at the output is all that is needed to obtain a rail-to-rail output. As Figure 1 shows, the pressure sensor output voltage is input to the non-inverting terminal of the op amp and the ramp is input to the inverting terminal. Therefore, when the pressure sensor voltage is higher than a given ramp voltage, the output is high; likewise, when the pressure sensor voltage is lower than a given ramp voltage, the output is low (refer to Figure 5). As mentioned in the Pressure Sensor section, resistors R1 and R2 of Figure 1 comprise the voltage divider that attenuates the pressure sensor's signal to a 2.0 V span ranging from 0.25 V to 2.25 V.

Since the pressure sensor voltage does not reach the ramp's minimum and maximum voltages, there will be a finite minimum and maximum pulse width for the PWM output. These minimum and maximum pulse widths are design constraints dictated by the comparator's slew rate. The system design ensures a minimum positive and negative pulse width of 20  $\mu\text{s}$  to avoid nonlinearities at the high and low pressures where the positive duty cycle of the PWM output is at its extremes (refer to Figure 4). Depending on the speed of the microcontroller used in the system, the minimum required pulse width may be larger. This will be explained in the next section.

THE MICROCONTROLLER

The microcontroller for this application requires input capture and output compare timer channels. The output capture pin is programmed to output the pulse train that drives the ramp generator, and the input capture pin detects edge transitions to measure the PWM output pulse width.

Since software controls the entire system, a calibration routine may be implemented that allows an adjustment of the frequency and pulse width of the pulse train until the desired ramp waveform is obtained. Depending on the speed of the microcontroller, additional constraints on the minimum and maximum PWM output pulse widths may apply. For this design, the software latency incurred to create the pulse train

at the output compare pin is approximately 40 μs. Consequently, the microcontroller cannot create a pulse train with a positive pulse width of less than 40 μs. Also, the software that measures the PWM output pulse width at the input capture pin requires approximately 20 μs to execute. Referring to Figure 5, the software interrupt that manipulates the pulse train always occurs near an edge detection on the input capture pin (additional software interrupt). Therefore, the minimum PWM output pulse width that can be accurately detected is approximately 60 μs (20 μs + 40 μs). This constrains the minimum and maximum pulse widths more than the slew rate of the comparator which was discussed earlier (refer to Figure 4).

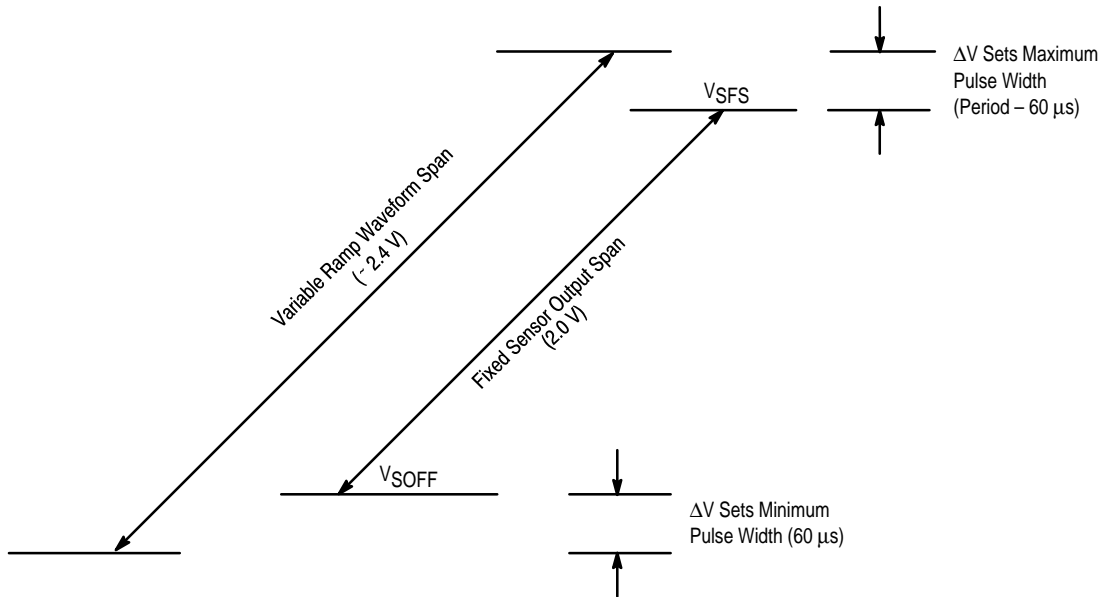

Figure 4. Desired Relationship Between the Ramp Waveform and Pressure Sensor Voltage Spans

An additional consideration is the resolution of the PWM output. The resolution is directly related to the maximum frequency of the pulse train. In our design, 512 μs are required to obtain at least 8-bit resolution. This is determined by the fact that a 4 MHz crystal yields a 2 MHz clock speed in the microcontroller. This, in turn, translates to 0.5 μs per clock tick. There are four clock cycles per timer count. This results in 2 μs per timer count. Thus, to obtain 256 timer counts (or 8-bit resolution), the difference between the zero pressure and full scale pressure PWM output pulse widths must be at least 512 μs (2 μs x 256). But since an additional 60 μs is needed at both pressure extremes of the output waveform, the total period must be at least 632 μs. This translates to a maximum frequency for the pulse train of approximately 1.6 kHz. With this frequency, voltage span of the ramp generator, and value of current charging the capacitor, the minimum capacitor value may be calculated with Equation 1.

To summarize:

The MC68HC705P9 runs off a 4 MHz crystal. The microcontroller internally divides this frequency by two to yield an internal clock speed of 2 MHz.

$$\frac{1}{2 \text{ MHz}} = > \frac{0.5 \mu\text{s}}{\text{clock cycle}}$$

And,

4 clock cycles = 1 timer count.

Therefore,

$$\frac{4 \text{ clock cycles}}{\text{timer count}} \times \frac{0.5 \mu\text{s}}{\text{clock cycle}} = \frac{2 \mu\text{s}}{\text{timer count}}$$

For 8-bit resolution,

$$\frac{2 \mu\text{s}}{\text{timer count}} \times 256 \text{ counts} = 512 \mu\text{s}$$

Adding a minimum of 60 μs each for the zero and full scale pressure pulse widths yields

$$512 \mu\text{s} + 60 \mu\text{s} + 60 \mu\text{s} = 632 \mu\text{s},$$

which is the required minimum pulse train period to drive the ramp generator.

Translating this to frequency, the maximum pulse train frequency is thus

$$\frac{1}{632 \mu\text{s}} = 1.58 \text{ kHz.}$$

## CALIBRATION PROCEDURE AND RESULTS

The following calibration procedure will explain how to systematically manipulate the pulse train to create a ramp that meets the necessary design constraints. The numbers used here are only for this design example. Figure 6 shows the linearity performance achieved by following this calibration procedure and setting up the ramp as indicated by Figures 4 and 5.

1. Start with a pulse train that has a pulse width and frequency that creates a ramp with about 100 mV dc offset and a span smaller than required. In this example the initial pulse width is 84  $\mu\text{s}$  and the initial frequency is 1.85 kHz.
2. **Decrease the frequency** of the pulse train until the ramp span increases to approximately 2.4 V. The ramp span of

2.4 V will ensure that the maximum pulse width at full scale pressure will be at least 60  $\mu\text{s}$  less than the total period. Note that by **decreasing the frequency** of the pulse train, a dc offset will begin to appear. This may result in the ramp looking nonlinear at the top.

3. If the ramp begins to become nonlinear, **increase the pulse width** to decrease the dc offset.
4. Repeat steps 2 and 3 until the ramp spans 2.4 V and has a dc offset of approximately 100 mV. The dc offset value is not critical, but the bottom of the ramp should have a "crisp" point at which the capacitor stops discharging and begins charging. Simply make sure that the minimum pulse width at zero pressure is at least 60  $\mu\text{s}$ . Refer to Figures 4 and 5 to determine if the ramp is sufficient for the application.

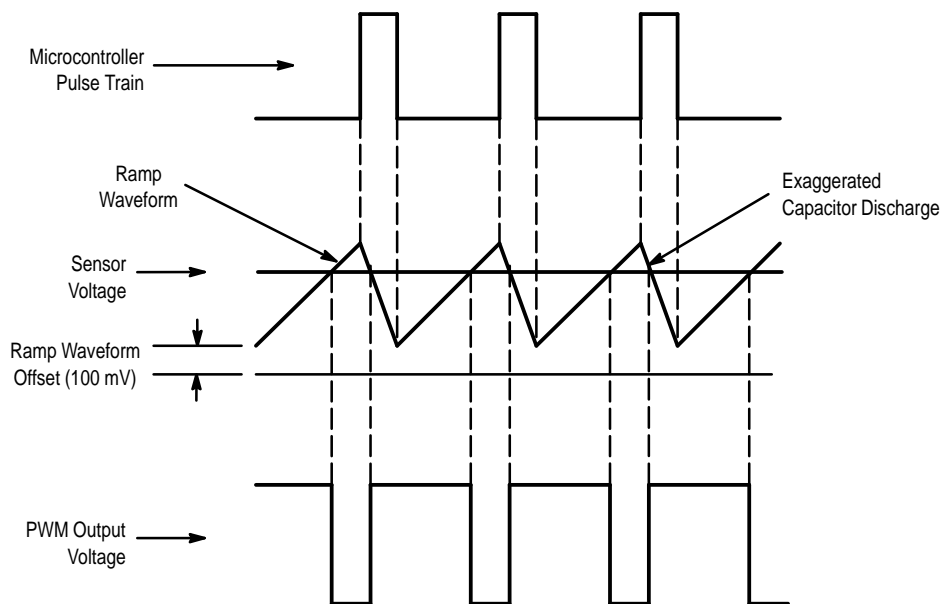

Figure 5. Relationships Between the PWM Output Pressure Sensor Voltages

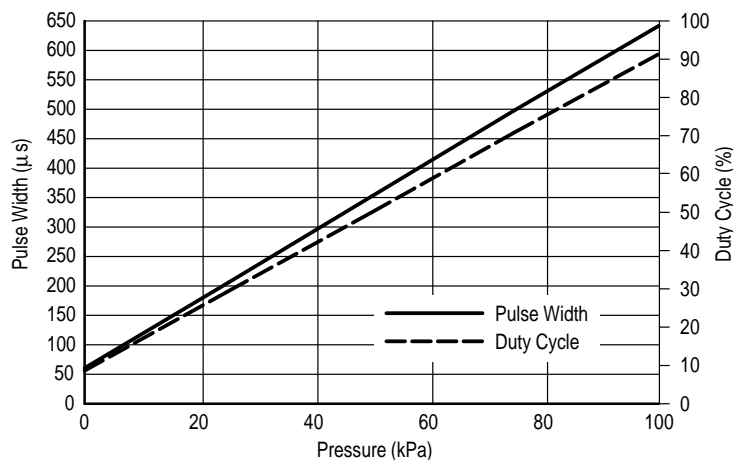



Figure 6. PWM Output Pressure Sensor Linearity Data

## CONCLUSION

The Pulse Width Modulated Output Pressure Sensor uses a ramp generator to create a linear ramp which is compared to the amplified output of the pressure sensor at the input of a comparator. The resulting output is a digital waveform with a duty cycle that is linearly proportional to the input pressure. Although the pressure sensor output has a fixed offset and

span, the ramp waveform is adjustable in frequency, dc offset, and voltage span. This flexibility enables the effect of component tolerances to be nullified and ensures that ramp span encompasses the pressure sensor output range. The ramp's span can be set to allow for the desired minimum and maximum duty cycle to guarantee a linear dynamic range.

Motorola reserves the right to make changes without further notice to any products herein. Motorola makes no warranty, representation or guarantee regarding the suitability of its products for any particular purpose, nor does Motorola assume any liability arising out of the application or use of any product or circuit, and specifically disclaims any and all liability, including without limitation consequential or incidental damages. "Typical" parameters which may be provided in Motorola data sheets and/or specifications can and do vary in different applications and actual performance may vary over time. All operating parameters, including "Typicals" must be validated for each customer application by customer's technical experts. Motorola does not convey any license under its patent rights nor the rights of others. Motorola products are not designed, intended, or authorized for use as components in systems intended for surgical implant into the body, or other applications intended to support or sustain life, or for any other application in which the failure of the Motorola product could create a situation where personal injury or death may occur. Should Buyer purchase or use Motorola products for any such unintended or unauthorized application, Buyer shall indemnify and hold Motorola and its officers, employees, subsidiaries, affiliates, and distributors harmless against all claims, costs, damages, and expenses, and reasonable attorney fees arising out of, directly or indirectly, any claim of personal injury or death associated with such unintended or unauthorized use, even if such claim alleges that Motorola was negligent regarding the design or manufacture of the part. Motorola and  are registered trademarks of Motorola, Inc. Motorola, Inc. is an Equal Opportunity/Affirmative Action Employer.

Mfax is a trademark of Motorola, Inc.

**How to reach us:**

**USA/EUROPE/Locations Not Listed:** Motorola Literature Distribution;  
P.O. Box 5405, Denver, Colorado 80217. 303-675-2140 or 1-800-441-2447

**JAPAN:** Nippon Motorola Ltd.; Tatsumi-SPD-JLDC, 6F Seibu-Butsuryu-Center,  
3-14-2 Tatsumi Koto-Ku, Tokyo 135, Japan. 81-3-3521-8315

**Mfax™:** RMFAX0@email.sps.mot.com – TOUCHTONE 602-244-6609  
– US & Canada ONLY 1-800-774-1848

**ASIA/PACIFIC:** Motorola Semiconductors H.K. Ltd.; 8B Tai Ping Industrial Park,  
51 Ting Kok Road, Tai Po, N.T., Hong Kong. 852-26629298

**INTERNET:** <http://motorola.com/sps>

