

# AN1585

## High-Performance, Dynamically-Compensated Smart Sensor System

by: Eric Jacobsen and Jeff Baum  
Systems Engineering Group  
Sensor Products Division  
Motorola Semiconductor Products Sector  
Phoenix, Arizona

### INTRODUCTION

The "front-end" sensor is the heart of any measuring system that requires a given physical condition to be transduced into an electrical variable. While the system presented in this paper has relevance to virtually all types of sensors, the case of converting a physical pressure to a voltage potential (via a micromachined semiconductor device), and subsequently to a numeric representation in the digital domain, will serve as the example presented here. Accuracy and resolution are the critical performance criteria that are native to such measuring systems.

Although all sources of measurement error cumulatively affect accuracy and resolution in a negative manner, sensor systems tend to obey the principle of "a chain only being as strong as its weakest link". In the case of today's sensor systems, it has become apparent that the overall system performance is typically limited by the less-than-ideal behaviors of the sensor devices. For piezoresistive pressure sensors, device-to-device variations in offset voltage and pressure sensitivity and temperature drift are the dominant sources of error.

The typical data acquisition system topology for most sensor applications includes a transducer, interface/signal conditioning circuitry associated with the transducer, an analog-to-digital converter (A/D), and a digital processing unit. In addressing the above sensor performance drawbacks, one could either pursue drastically improving the device design, semiconductor processing, and packaging of conventional sensor devices, or choose to accommodate and compensate these error-inducing variations via a radical departure from conventional signal conditioning and digital processing system designs. While the single goal of such a system design is to minimize the total measurement error, this objective has been accomplished by a three-fold approach. A system has been developed and demonstrated that eliminates device-to-device process variations, corrects for temperature dependencies of the sensor output, and optimizes the available resolution by means of a closed-loop, MCU-based, dynamic compensation system. This system philosophy and topology is presented as the final generation in an evolution that was directed at achieving a high-performance sensing system that is built around a low-cost, extremely non-ideal sensor device. In order to better facilitate an understanding of this, so-called, dynamic compensation system, a brief description of each of the prior generations of this evolution is also presented.

### DEFINING RESOLUTION AND ACCURACY

Performance of a pressure sensor system is directly related to its resolution. Resolution is the smallest increment of pressure that the system can resolve — e.g. a system that measures pressure up to 10 kPa (full-scale) with a resolution of 1% of full-scale can resolve pressure increments of 0.1 kPa. Similarly, the resolution (smallest increment of voltage) of an 8-bit A/D converter (see Figure 1) with a 5 volt window (a high reference voltage of 5 V and a low reference voltage of 0 V) is

$$\text{Smallest Increment} = \frac{5.0 \text{ V}}{255 \text{ steps}} = 19.6 \frac{\text{mV}}{\text{step}}$$

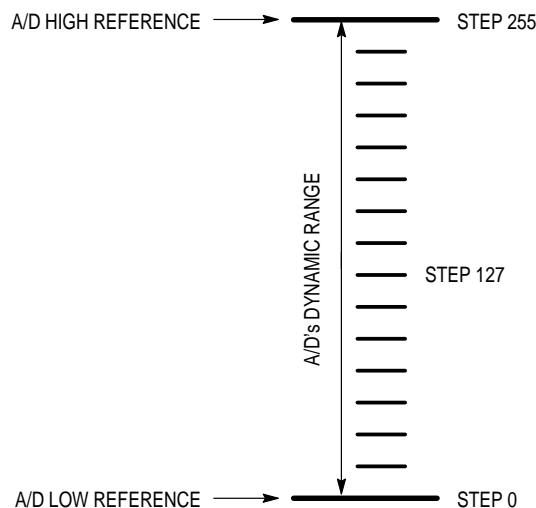

Figure 1. The 255 Digital Steps of an 8-Bit A/D

If the above system example requires 1% resolution when interfaced to an A/D, the pressure sensor signal's span must be at least

$$\text{Signal Span} = \frac{19.6 \text{ mV}}{0.01} = 1.96 \text{ V}$$

Similarly, if the system resolution required is 0.5%, the pressure sensor signal's span must be at least

$$\text{Signal Span} = \frac{19.6 \text{ mV}}{0.005} = 3.92 \text{ V}$$

## AN1585

From practical experience, an assumption is made that accuracy and resolution performance are related in the following manner:

$$\text{Accuracy} = 2 \cdot \text{Resolution}$$

This conservative relationship between accuracy and resolution is based on the fact that for an A/D, the digital quantization of the pressure signal can be plus or minus one step. Therefore, assume that it takes twice the number of steps previously determined to resolve a given minimum accuracy and incremental pressure.

### HARDWARE CALIBRATION ONLY

One method of compensating a sensor's signal utilizes a customized amplifier design to position the sensor's zero-pressure offset and full-scale output at predetermined values (at a given temperature). For systems with a single regulated 5.0 V supply, the transfer function of the amplifier's output has historically and manually been adjusted for a 0.5 V zero-pressure offset and 4.5 V full-scale output (i.e. the amplifier's offset voltage pedestal and gain are modified) to "calibrate out" any of the device-to-device variations in the sensor's inherent zero-pressure offset and span. This amplified dynamic range allows for maximum static-temperature accuracy while also conservatively remaining within the linear output range of the amplifier (assuming a "rail-to-rail" op-amp is being used in the amplifier interface).

For this design, the number of A/D steps (bits) used is

$$\# \text{ of A/D steps (bits)} = \frac{4.0 \text{ V}}{5.0 \text{ V}} \cdot 255 \text{ steps} = 200 \text{ steps}$$

Therefore the resolution is

$$\text{Resolution} = \frac{1}{200 \text{ steps}} = 0.5\% \text{ fullscale}$$

Using the aforementioned criteria for calculating accuracy

$$\text{Accuracy} = 2 \cdot \text{Resolution} = 1.0\% \text{ full-scale}$$

The system's resolution is depicted graphically in Figure 2, where the sensor's dynamic signal is shown to utilize 80% (4.0 V/5.0 V) of the A/D's bits.

Unfortunately, as mentioned previously, the above accuracy is defined only for static-temperature situations.

Temperature fluctuations in the system can create large fluctuations and drift in the sensor signal, thereby degrading the overall sensor accuracy.

### FIXED-HARDWARE INTERFACE WITH OPEN-LOOP SOFTWARE COMPENSATION

This technique performs both calibration (static-temperature) and temperature compensation of the sensor via software. Since the sensor's signal is compensated totally in software (no manual calibration of potentiometers, etc.), the fixed-value circuitry must be designed so that the sensor's signal is always within the high and low reference voltages of the A/D converter regardless of any sensor-to-sensor, component, or temperature variations in the system. To accomplish this goal a design methodology was established previously to determine the correct gain- and offset-setting resistors for the amplifier. This methodology works with the following criteria:

As discussed previously, to obtain the best signal resolution with an A/D, the sensor's amplified dynamic output voltage range should fill as much of the A/D window (difference between the A/D's high and low reference voltages) as possible without extending beyond the high and low reference voltages (i.e. the zero-pressure offset voltage must be greater than or equal to the low reference voltage, and the full-scale output voltage must be less than or equal to the high reference voltage).

The methodology designs a fixed-value circuit that optimizes performance (signal resolution) while taking into account all possible types of variation that may cause the sensor output to vary. Through this design methodology, the best sensor accuracy is achieved while ensuring through design, regardless of any system variation, that the sensor's amplified output will ALWAYS be within the saturation levels of the amplifier and the high and low reference voltages of the A/D converter.

Unfortunately, this restricts the sensor's true signal to a relatively small portion of the A/D's range since some of the bits are required for "headroom" to allow the sensor's signal to drift within the A/D window due to these sensor-to-sensor, component and temperature variations. Thus the resolution and overall accuracy are adversely affected.

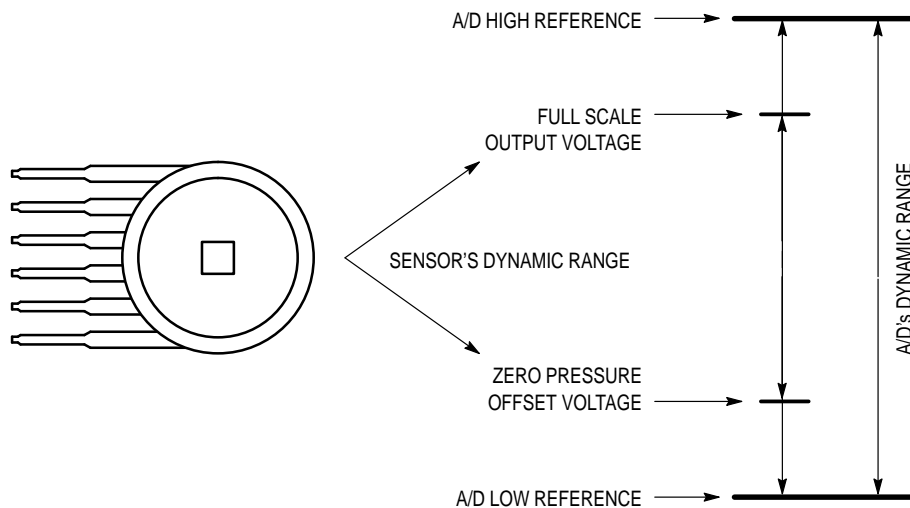

Figure 2. Sensor Dynamic Range with Hardware Calibration

However, by using the design methodology above, now the accurate open-loop software calibration and temperature compensation (with in-system temperature monitoring circuitry) of the sensor's output is possible. By sampling the pressure sensor's zero-pressure offset and full-scale-pressure output and the temperature monitoring circuit's output at two different temperatures, all of the temperature, device-to-device, and circuit variations can be fairly well-compensated.

Via this technique, the same sensor used in Hardware Calibration yields a best case accuracy of 4.5% full-scale (resolution of 2.25% full-scale) over the system's operating temperature range. This translates to using 51% of the A/D's quantization intervals ("bits") for the sensor's dynamic signal (see Figure 3). The remaining 49% of the A/D's bits are used as signal drift margin ("headroom") to allow for various system tolerances (voltage regulator tolerance, resistor tolerances, etc.) and the sensor's device-to-device and temperature variations.

### HYBRID SOLUTION

The previous two techniques may be combined to obtain a hybrid solution. This hybrid solution is manually-calibrated at room temperature as is the case for the Hardware Calibration. Additionally an open-loop software temperature compensation routine is implemented to maintain good accuracy over temperature. However, calculations must be performed to determine how much headroom is required to allow for temperature variations only (remember that

sensor-to-sensor and component variations are eliminated with the manual calibration!) in the sensor's output to guarantee that the sensor's signal remains within the A/D window over temperature. Since headroom is required for these temperature variations, a 0.5 V to 4.5 V manual calibration may not be possible since it does not allow enough headroom for temperature drift (e.g. the zero pressure offset may be designed to be at 0.75 V and the full-scale output at 4.25 V to allow room for the sensor's signal to drift over temperature and still remain within the A/D's window). Thus, this hybrid technique will experience better accuracies over temperature than the Fixed-Hardware Interface with Open-loop Software Compensation (more bits are used for the true signal and fewer bits are used for headroom since the only headroom component is temperature variations) but will experience poorer accuracies for static-temperature cases compared to the Hardware Calibration (fewer bits are used for the sensor's dynamic range).

### DYNAMIC COMPENSATION

Dynamic Compensation achieves what the other techniques cannot achieve. Dynamic Compensation allows the sensor signal to fill the entire A/D's range (Figure 4). By utilizing the entire A/D range, higher resolutions and accuracies are possible. Using Dynamic Compensation with a typical 8-bit A/D, over 90+% of the A/D's bits are used for the sensor's true signal span, resulting in accuracies better than 1% and a resolution as good as 0.4%.

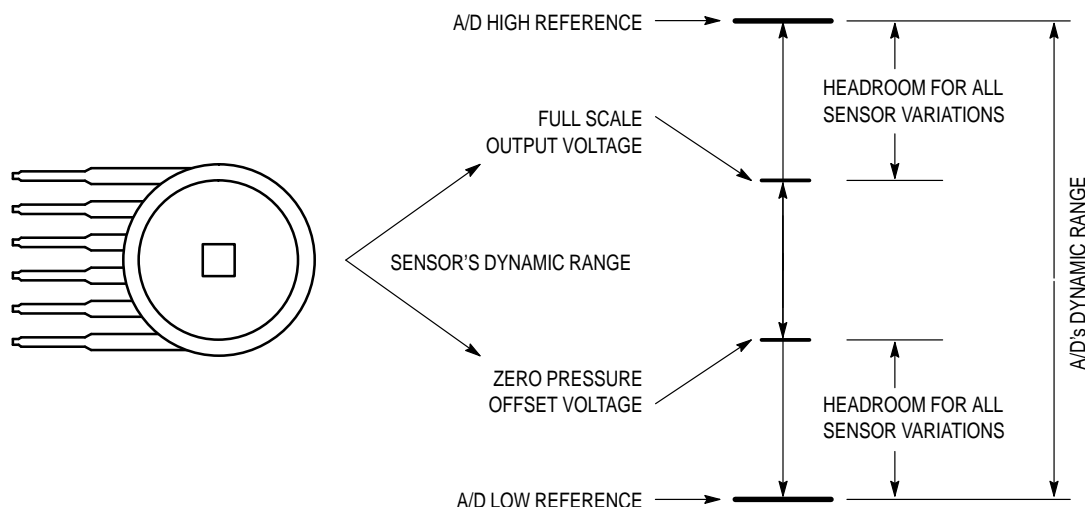

**Figure 3. Sensor Dynamic Range for the Fixed-Hardware Interface with Open-Loop Software Compensation**

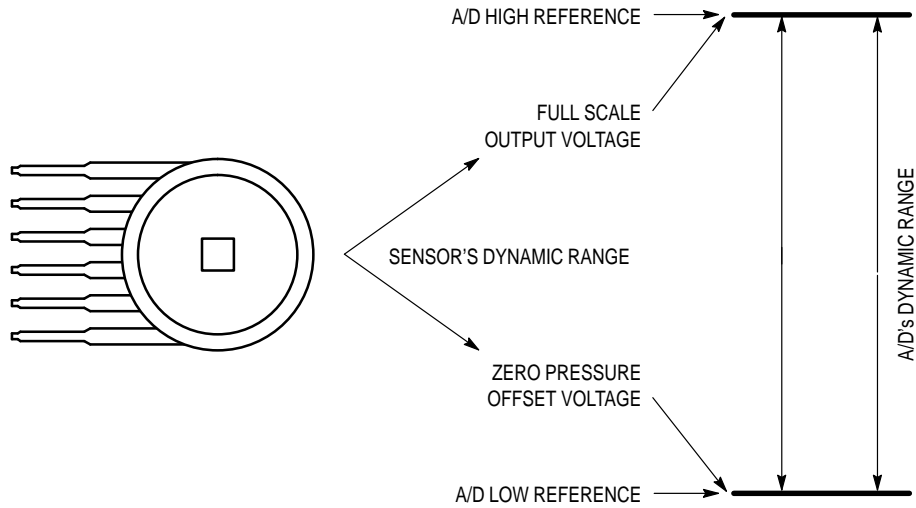

\*\* NO HEADROOM REQUIRED DUE TO DYNAMIC COMPENSATION OF SENSOR SIGNAL

**Figure 4. Sensor Dynamic Range with Dynamic Compensation**

Dynamic Compensation uses a closed-loop topology to dynamically compensate the sensor signal to eliminate sensor-to-sensor and temperature variations in the sensor's output. Refer to the block diagram of the smart sensor system in Figure 5. Dynamic Compensation uses 3 digital-to-analog (D/A) feedback loops to dynamically (real-time) adjust the sensor's signal. Two D/A feedback loops dynamically maintain the desired zero-pressure offset level. The third D/A feedback loop provides dynamic gain control to adjust and maintain the desired sensor span. Because the sensor signal is dynamically compensated, no A/D bits are required to be reserved for sensor-to-sensor and temperature variations (i.e. headroom); consequently, nearly all the A/D's bits are

available for the true sensor signal.

The actual circuit topology shown in Figure 6 is based around Motorola's MC68HC705P9 microcontroller. The "P9" is programmed with all the required mathematics routines to provide the dynamic compensation (the microcontroller is part of the feedback loop). The added benefits of a microcontroller-based system are the "smart sensor" features such as software calibration and temperature compensation (dynamic compensation), in-field recalibration capability, self-test and self-diagnostic features, dynamic zero (tare adjust), transducer electronic data sheet (TEDS), and serial communications interface.

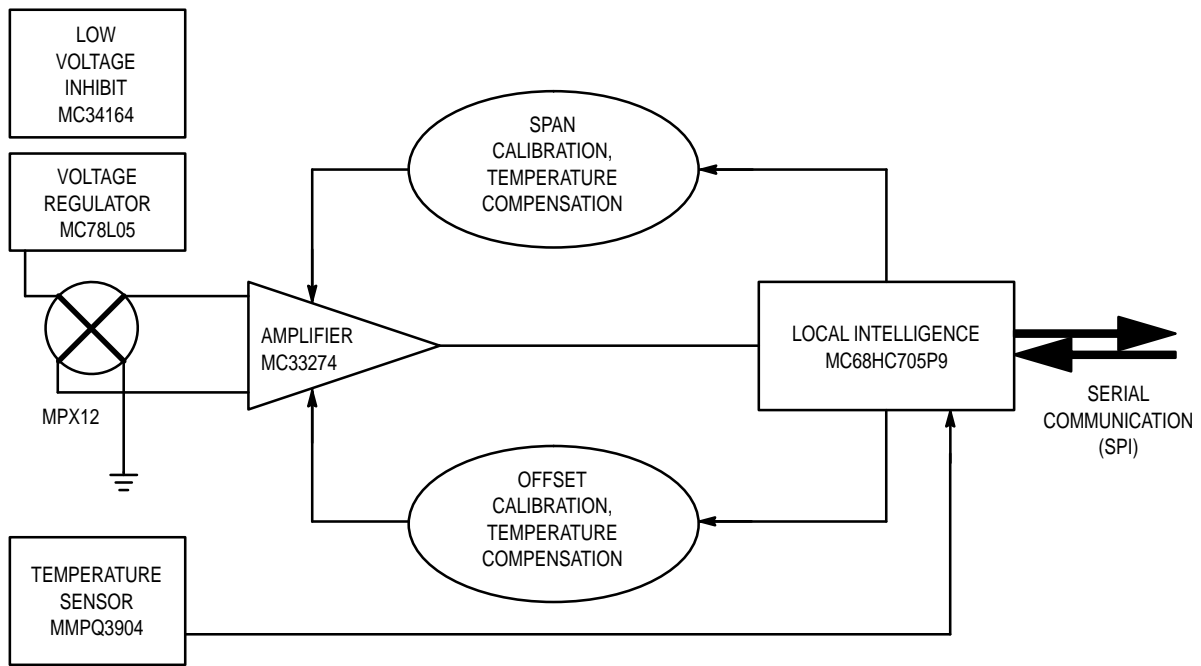

**Figure 5. Dynamically-Compensated Smart Sensor Block Diagram**

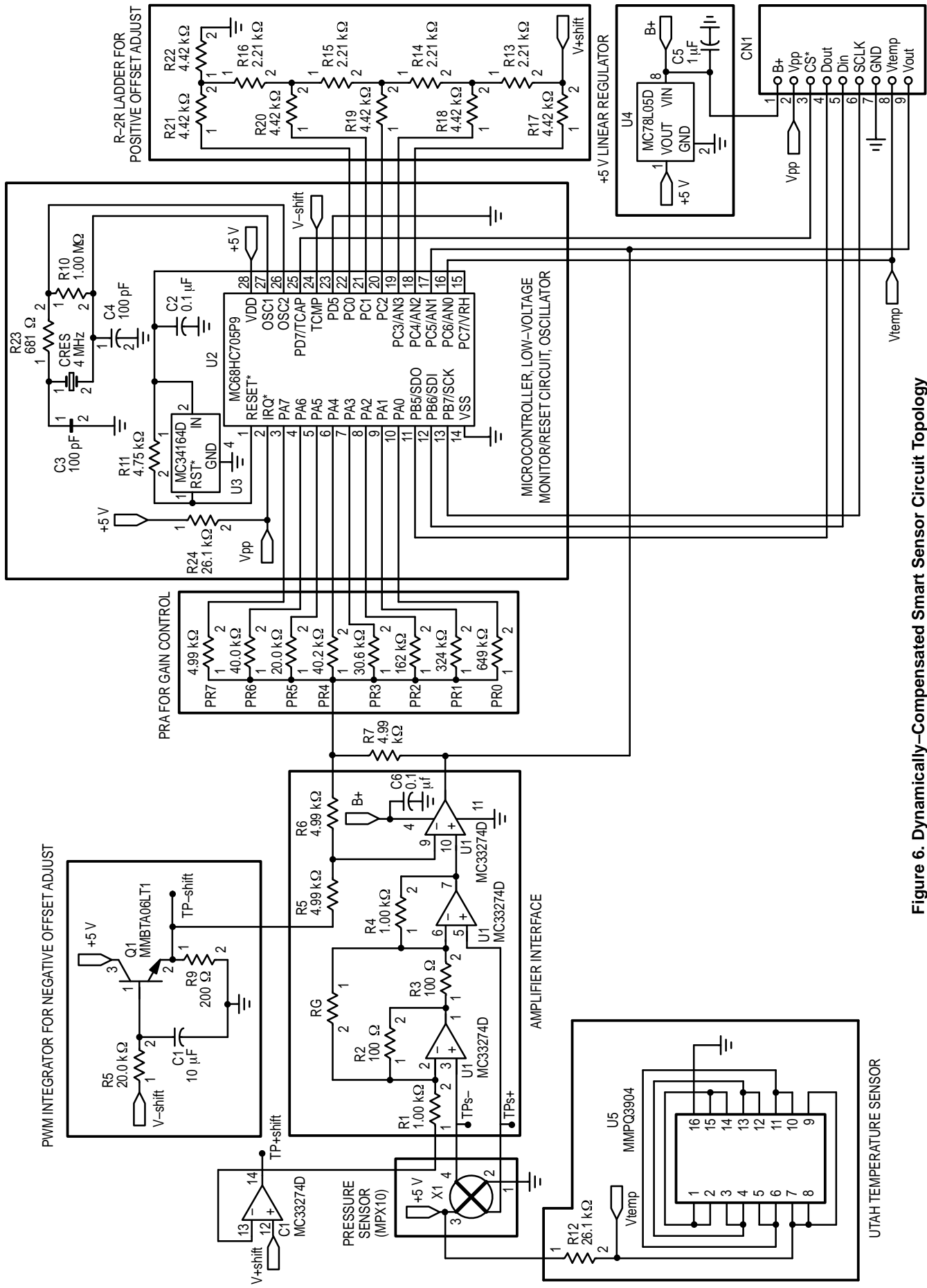

Figure 6. Dynamically-Compensated Smart Sensor Circuit Topology

## SUMMARY

The three sensor calibration/compensation techniques have been discussed with the results shown in Table 1. The first technique, Hardware Calibration, uses a customized amplifier to eliminate sensor-to-sensor variations. It achieves good accuracy and resolution for static-temperature situations; however, large errors in the system result from temperature variations in the system (no temperature compensation performed). This technique also requires labor-intensive manufacturing to customize the amplifier's transfer function for a specific sensor offset and span.

The second technique, Fixed-Hardware Interface with Open-loop Software Compensation, uses fixed-value system circuitry that is designed such that the sensor's dynamic signal over all sensor-to-sensor and temperature variations will remain within the A/D's window. Then an open-loop software calibration and temperature compensation routine is implemented. The solution does provide decent compensation of the sensor signal over temperature; however, since many of the A/D's bits must be reserved for headroom, less of the A/D's bits are available for

the sensor's true signal. Consequently, the accuracy and resolution capabilities of the sensor system are adversely affected.

The third technique, Dynamic Compensation, incorporates a closed-loop circuit topology to dynamically compensate the sensor signal (both the sensor's offset and sensitivity are dynamically adjusted to maintain them at their desired levels). Since the sensor signal is compensated in real-time, no headroom is required for sensor-to-sensor nor temperature variations in the system. All of the A/D's bits are available for the sensor's true signal. The result is superior resolution and accuracy.

Finally, in addition to the dynamic compensation, the system incorporates "smart sensor" features with the embedded microcontroller. These smart sensing functions include software calibration and temperature compensation (dynamic compensation), in-field recalibration capability, self-test and self-diagnostic features, dynamic zero (tare adjust), transducer electronic data sheet (TEDS), and serial communications interface.

Table 1. Results Summary

Compensation Method	Accuracy (in % of full-scale)	Resolution (in % of full-scale)
Hardware Calibration	1% (single temp. only)	0.5% (single temp. only)
Fixed-Hardware Interface	4.5%	2.25%
Dynamic Compensation	< 1%	0.4%

Motorola reserves the right to make changes without further notice to any products herein. Motorola makes no warranty, representation or guarantee regarding the suitability of its products for any particular purpose, nor does Motorola assume any liability arising out of the application or use of any product or circuit, and specifically disclaims any and all liability, including without limitation consequential or incidental damages. "Typical" parameters which may be provided in Motorola data sheets and/or specifications can and do vary in different applications and actual performance may vary over time. All operating parameters, including "Typicals" must be validated for each customer application by customer's technical experts. Motorola does not convey any license under its patent rights nor the rights of others. Motorola products are not designed, intended, or authorized for use as components in systems intended for surgical implant into the body, or other applications intended to support or sustain life, or for any other application in which the failure of the Motorola product could create a situation where personal injury or death may occur. Should Buyer purchase or use Motorola products for any such unintended or unauthorized application, Buyer shall indemnify and hold Motorola and its officers, employees, subsidiaries, affiliates, and distributors harmless against all claims, costs, damages, and expenses, and reasonable attorney fees arising out of, directly or indirectly, any claim of personal injury or death associated with such unintended or unauthorized use, even if such claim alleges that Motorola was negligent regarding the design or manufacture of the part. Motorola and  are registered trademarks of Motorola, Inc. Motorola, Inc. is an Equal Opportunity/Affirmative Action Employer.

Mfax is a trademark of Motorola, Inc.

**How to reach us:**

**USA/EUROPE/Locations Not Listed:** Motorola Literature Distribution;  
P.O. Box 5405, Denver, Colorado 80217. 303-675-2140 or 1-800-441-2447

**JAPAN:** Nippon Motorola Ltd.; Tatsumi-SPD-JLDC, 6F Seibu-Butsuryu-Center,  
3-14-2 Tatsumi Koto-Ku, Tokyo 135, Japan. 81-3-3521-8315

**Mfax™:** RMFAX0@email.sps.mot.com – TOUCHTONE 602-244-6609  
– US & Canada ONLY 1-800-774-1848

**ASIA/PACIFIC:** Motorola Semiconductors H.K. Ltd.; 8B Tai Ping Industrial Park,  
51 Ting Kok Road, Tai Po, N.T., Hong Kong. 852-26629298

**INTERNET:** <http://motorola.com/sps>

