

M68MPB16Z1UM/D
REV 1

March 1998

M68MPB16Z1
MCU PERSONALITY BOARD
USER'S MANUAL

Motorola reserves the right to make changes without further notice to any products herein to improve reliability, function or design. Motorola does not assume any liability arising out of the application or use of any product or circuit described herein; neither does it convey any license under its patent rights nor the rights of others. Motorola products are not designed, intended, or authorized for use as components in systems intended for surgical implant into the body, or other applications intended to support or sustain life, or for any other application in which the failure of the Motorola product could create a situation where personal injury or death may occur. Should Buyer purchase or use Motorola products for any such unintended or unauthorized application, Buyer shall indemnify and hold Motorola and its officers, employees, subsidiaries, affiliates, and distributors harmless against all claims, costs, damages, and expenses, and reasonable attorney fees arising out of, directly or indirectly, any claim of personal injury or death associated with such unintended or unauthorized use, even if such claim alleges that Motorola was negligent regarding the design or manufacture of the part.

Motorola and the Motorola logo are registered trademarks of Motorola Inc. SDI is a trademark of Motorola Inc.

Motorola Inc. is an Equal Opportunity/Affirmative Action Employer.

CONTENTS

CHAPTER 1 GENERAL INFORMATION

1.1	INTRODUCTION.....	1-1
1.2	SPECIFICATIONS	1-2
1.3	EQUIPMENT REQUIRED.....	1-2
1.4	CUSTOMER SUPPORT	1-3

CHAPTER 2 HARDWARE PREPARATION AND INSTALLATION

2.1	INTRODUCTION.....	2-1
2.2	HARDWARE PREPARATION	2-1
2.2.1	Clock Select Header (W1).....	2-4
2.2.2	VDDA Select Header (W2).....	2-5
2.2.3	Voltage Reference High Select Header (W3).....	2-6
2.2.4	Voltage Reference Low Select Header (W4).....	2-7
2.2.5	VSSA Insertion Point (E1)	2-7
2.3	MEVB CONFIGURATION.....	2-8
2.4	ACTIVE PROBE CONFIGURATION.....	2-10

CHAPTER 3 MEVB QUICK START GUIDE

3.1	INTRODUCTION.....	3-1
3.2	CONFIGURING THE MPFB.....	3-1
3.2.1	MPFB Memory Devices.....	3-1
3.2.2	MPFB Jumper Headers.....	3-2
3.3	MEVB INSTALLATION INSTRUCTIONS.....	3-3
3.3.1	Power Supply – MPFB Connection.....	3-4
3.3.2	Personal Computer – BDM Connection.....	3-5
3.4	SOFTWARE INSTALLATION AND MCU INITIALIZATION.....	3-5

CHAPTER 4 MEVB SUPPORT INFORMATION

4.1	INTRODUCTION.....	4-1
4.2	LOGIC ANALYZER CONNECTOR SIGNALS.....	4-1

CHAPTER 5 MAPI SUPPORT INFORMATION

5.1	INTRODUCTION.....	5-1
5.2	MAPI BUS CONNECTORS	5-1

CHAPTER 6 SCHEMATIC DIAGRAMS

6.1	INTRODUCTION.....	6-1
-----	-------------------	-----

FIGURE

2-1.	MPB Parts Location Diagram (top view).....	2-2
2-2.	MPB – MPFB Interconnection (with SDI interface connector).....	2-9
2-3.	Active Probe Interconnection (with Active Probe Box)	2-11
5-1.	MAPI Interface Connector Layout.....	5-1
5-2.	MAPI Interface Connector P1 Pin Assignments.....	5-2
5-3.	MAPI Interface Connector P2 Pin Assignments.....	5-3
5-4.	MAPI Interface Connector P3 Pin Assignments.....	5-4
5-5.	MAPI Interface Connector P4 Pin Assignments.....	5-5

TABLES

1-1.	MPB Specifications.....	1-2
2-1.	Jumper Header Types.....	2-3
2-2.	MPB Jumper Header Descriptions.....	2-3
3-1.	MPFB Quick Start Jumper Header Configuration	3-2
4-1.	Logic Analyzer Connector J7 Pin Assignments.....	4-2
4-2.	Logic Analyzer Connector J8 Pin Assignments.....	4-2
4-3.	Logic Analyzer Connector J9 Pin Assignments.....	4-3
4-4.	Logic Analyzer Connector J10 Pin Assignments.....	4-3
4-5.	Logic Analyzer Connector J11 Pin Assignments.....	4-4
4-6.	Logic Analyzer Connector J12 Pin Assignments.....	4-4
4-7.	Logic Analyzer Connector J13 Pin Assignments.....	4-6
4-8.	Logic Analyzer Connector J14 Pin Assignments.....	4-8
4-9.	Logic Analyzer Connector J15 Pin Assignments.....	4-9
4-10.	Logic Analyzer Connector J16 Pin Assignments.....	4-9
4-11.	Logic Analyzer Connector J17 Pin Assignments.....	4-10
4-12.	Logic Analyzer Connector J18 Pin Assignments.....	4-11
4-13.	Logic Analyzer Connector J19 Pin Assignments.....	4-12
4-14.	Logic Analyzer Connector J20 Pin Assignments.....	4-12

CHAPTER 1

GENERAL INFORMATION

1.1 INTRODUCTION

This manual provides general information, hardware preparation, installation instructions, a quick start guide, and support information for the M68MPB16Z1 MCU Personality Board (MPB). The MPB is one component of Motorola's modular approach to MC68HC16Z1 Microcontroller Unit-based product development. This modular approach lets you easily configure our development systems to fit your requirements.

The MPB may be used in either the MMDS1632 Motorola Modular Development System (MMDS) or the modular evaluation board (MEVB). The MEVB consists of the M68MPFB Modular Platform Board (MPFB) and an MPB. Alternately, you may install the MPB directly in your target system if the target system includes a modular active probe interconnect (MAPI) interface. The MCU device on the MPB defines which MCU is emulated/evaluated by the MMDS or evaluated by the MEVB. Both systems are invaluable tools for designing, debugging, and evaluating MCU operation of the M68HC12, M68HC16, and M68300 MCU families. By providing the essential MCU timing and I/O circuitry, these systems simplify user evaluation of prototype hardware/software products.

The MPB includes:

- M68MPB16Z1 MCU Personality Board (MPB)
- Plastic overlay for use with the MEVB – pin outs for the logic analyzer connectors on the MPFB (specifically for the MC68HC16Z1 MCU)
- Documentation (this manual)

1.2 SPECIFICATIONS

Table 1-1 lists MPB specifications.

Table 1-1. MPB Specifications

Characteristic	Specifications
On-Board Clock	Case style: 14- or 8-pin hybrid crystal clock oscillator (frequency as required by MCU).
External Clock	32 KHz – 16.78 MHz (or maximum MCU allows).
MCU I/O ports	HCMOS compatible
Temperature Operating Storage	0° to +40° C -40° to +85° C
Relative humidity	0 to 90% (non-condensing)
Power requirements	+5Vdc \pm 5% @ 500 mA (max.)
Dimensions MCU Personality Board	3.25 x 3.25 in. (82.6 x 82.6 mm)

1.3 EQUIPMENT REQUIRED

The external requirements for MPB operation are either an MEVB or MMDS system. For MMDS operation requirements, see the MMDS1632 Motorola Modular Development System User's Manual, MMDS1632UM/D. For operation requirements for the MEVB, see this manual and the M68MPFB Modular Platform Board User's Manual, M68MPFBUM/D.

1.4 CUSTOMER SUPPORT

For information about a Motorola distributor or sales office near you call:

AUSTRALIA, Melbourne – (61-3)887-0711 Sydney – 61(2)906-3855	JAPAN, Fukuoka – 81-92-725-7583 Gotanda – 81-3-5487-8311 Nagoya – 81-52-232-3500 Osaka – 81-6-305-1802 Sendai – 81-22-268-4333 Takamatsu – 81-878-37-9972 Tokyo – 81-3-3440-3311
BRAZIL, Sao Paulo – 55(11)815-4200	KOREA, Pusan – 82(51)4635-035 Seoul – 82(2)554-5118
CANADA, B. C., Vancouver – (604)606-8502 ONTARIO, Toronto – (416)497-8181 ONTARIO, Ottawa – (613)226-3491 QUEBEC, Montreal – (514)333-3300	MALAYSIA, Penang – 60(4)2282514
CHINA, Beijing – 86-10-68437222	MEXICO, Mexico City – 52(5)282-0230 Guadalajara – 52(36)21-8977
DENMARK – (45)43488393	PUERTO RICO, San Juan – (809)282-2300
FINLAND, Helsinki – 358-9-6824-400	SINGAPORE – (65)4818188
FRANCE, Paris – 33134 635900	SPAIN, Madrid – 34(1)457-8204
GERMANY, Langenhagen/Hannover – 49(511)786880 Munich – 49 89 92103-0 Nuremberg – 49 911 96-3190 Sindelfingen – 49 7031 79 710 Wiesbaden – 49 611 973050	SWEDEN, Solna – 46(8)734-8800
HONG KONG, Kwai Fong – 852-6106888 Tai Po – 852-6668333	SWITZERLAND, Geneva – 41(22)799 11 11 Zurich – 41(1)730-4074
INDIA, Bangalore – (91-80)5598615	TAIWAN, Taipei – 886(2)717-7089
ISRAEL, Herzlia – 972-9-590222	THAILAND, Bangkok – 66(2)254-4910
ITALY, Milan – 39(2)82201	UNITED KINGDOM, Aylesbury – 441(296)395-252
	UNITED STATES, Phoenix, AZ – 1-800-441-2447

For a list of the Motorola sales offices and distributors:

http://www.mcu.motsps.com/sale_off.html



CHAPTER 2

HARDWARE PREPARATION AND INSTALLATION

2.1 INTRODUCTION

This chapter provides unpacking instructions, hardware preparation information, and installation instructions for the MPB.

When you unpack the MPB from its shipping carton, verify that all items are in good condition. Save packing material for storing and shipping the MPB.

NOTE

Should the MPB arrive damaged, save all packing material, and contact the carrier's agent.

2.2 HARDWARE PREPARATION

This portion of the manual explains how to prepare the MPB before use, as well as how to configure the MPB for system operation. This section also explains MPB installation in the MMDS and MEVB.

The MPB has been factory tested and is shipped with installed jumpers. A jumper installed on a jumper header provides a connection between two points in the MPB circuit. The MPB has two types of jumper headers: three-pin and two-pin with a cut-trace short. A cut-trace short has a copper trace between the feed-through holes (bottom or solder side of the MPB). Table 2-1 describes each type of jumper header.

The MPB has four jumper headers (for which Table 2-2 is a quick reference guide). You may reconfigure these jumper headers to customize MPB functionality. The following paragraphs explain each jumper header function. There is also an insertion point (E1) for connecting an external ground.

NOTE

Verify that all socketed parts are seated in their sockets.

CAUTION

Depending on your application, it may be necessary to cut the W2 wiring trace short (cut-trace short). Be careful not to cut adjacent PCB traces, nor cut too deep into the multi-layer circuit board.

If the cut-trace short on a jumper header is already cut, you can return the MPB to its default setting by installing a user-supplied fabricated jumper.

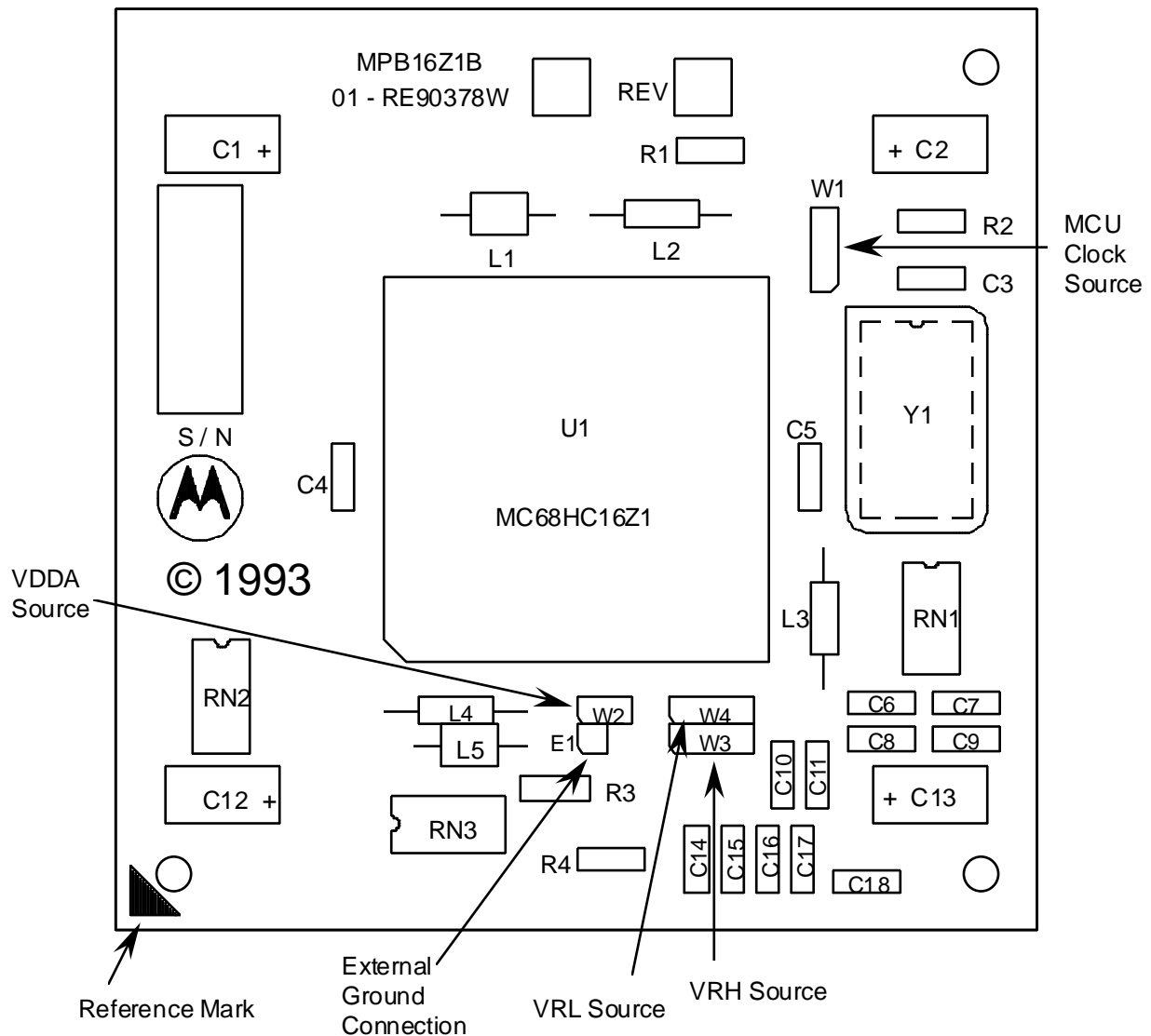

Figure 2-1. MPB Parts Location Diagram (top view)

Table 2-1. Jumper Header Types







Jumper Header Type	Symbol	Description
two-pin with cut-trace short		Two-pin jumper header with cut-trace short, designated WX, where X = the jumper header number. If you cut the short, use a fabricated jumper to return the jumper header to its factory default state.
three-pin		Three-pin jumper header, designated WX, where X = the jumper header number. Use a fabricated jumper to create a connection between two of the three pins of the jumper header.

Table 2-2. MPB Jumper Header Descriptions

Jumper Header	Type	Description
W1	1  2 3	Jumper between pins 1 and 2 (factory default); selects the MPB on-board crystal clock source. Jumper between pins 2 and 3; selects an external clock source to be the MCU EXTAL input signal.
W2	1  2 3	Jumper installed or cut-trace short intact (factory default); selects the on-board VDDA power source. No jumper or cut-trace short; lets you connect an external power source to W2 pin 2 and the external-power-source ground to E1. <p style="text-align: center;">NOTE</p> <p style="text-align: center;">Jumper header W2 is not populated by the factory.</p>
W3	1  2 3	Jumper installed on pins 1 and 2 (factory default); selects the MPB on-board VRH power source. Jumper installed on pins 2 and 3; selects external VRH power source.
W4	1  2 3	Jumper installed on pins 1 and 2 (factory default); selects the MPB on-board VRL power source. Jumper installed on pins 2 and 3; selects external VRL power source.

2.2.1 Clock Select Header (W1)

Jumper header W1 connects the MCU external clock (EXTAL) pin to either an on-board or external (target-system) clock source. The drawing below shows the factory configuration: a fabricated jumper on pins 1 and 2. This configuration selects the MPB on-board clock source; crystal oscillator in the Y1 socket. (This crystal provides for operation at the maximum rate the MCU allows via the internal phase-locked loop or direct clock input.)

If you install the MPB in the active probe or directly on a target system, and use the target system clock as the MPB clock, move the fabricated jumper to W1 pins 2 and 3. This connects the MCU EXTAL pin to the MAPI bus input pin. The frequency of the external clock signal can be from 32 KHz to 16.78 MHz (or to the maximum the MCU allows).

W1

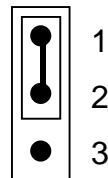

NOTE

You cannot drive the MPB clock circuit from an external source (target system) with a discrete crystal. If you use a target system clock source to drive the MPB clock circuit, always use a logic-driven clock such as a hybrid oscillator.

2.2.2 VDDA Select Header (W2)

Jumper header W2 selects the MPB VDDA power source: either MPB power (VDDI) or an external source. The drawing below shows the factory configuration: a cut-trace short between pins 1 and 2. This configuration connects filtered VDDI to VDDA.

To use an external power source, remove the cut-trace short from W2 pins 1 and 2, then connect the external power source to W2 pin 2. Removal of the cut-trace short isolates the MCU VDDA pin from the other MPB circuitry. Isolation lets you connect a precision VDDA source for accurate 10-bit analog/digital (A/D) generation. When connecting an external VDDA power supply to the MPB, connect the power supply ground to insertion point E1. For more information on A/D generation refer to the Analog-To-Digital Converter Reference Manual, ADCRM/AD.

W2

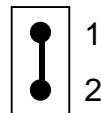

NOTES

If the cut-trace short has been cut, you must install a fabricated jumper on W2 to return it to the factory configuration.

Jumper header W2 is not populated by the factory.

2.2.3 Voltage Reference High Select Header (W3)

Jumper header W3 selects the voltage reference high (VRH) source: either MPB power (VDDA) or an external VRH source. The drawing below shows the factory configuration: a fabricated jumper on pins 1 and 2. This configuration selects VDDA as the VRH source.

To use an external VRH source, first place the fabricated jumper on W3 pins 2 and 3. Then connect the MCU VRH pin to the external VRH source. Each configuration defines the best method for connecting the MCU VRH pin to the external VRH source:

- **MPB/MPFB** – connect via the MPFB logic analyzer connector (refer to Chapter 4 for the appropriate logic analyzer pin).
- **MPB/MMDS1632** – connect via the VRH pin of the target MCU socket.
- **MPB/Target System** – connect via the VRH pin of the target system MAPI bus.

Alternately, you may remove the jumper and wire-wrap directly to W3 pin 2. Connecting directly to pin 2 is an option regardless of the configuration.

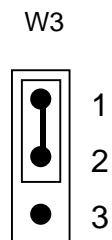

2.2.4 Voltage Reference Low Select Header (W4)

Jumper header W4 selects the voltage reference low (VRL) source: either MPB power (VSSA) or an external VRL source. The drawing below shows the factory configuration: a fabricated jumper on pins 1 and 2. This configuration selects VSSA as the VRL source.

To use an external VRL source, first place the fabricated jumper on W4 pins 2 and 3. Then connect the MCU VRL pin to the external VRL source. Each configuration defines the best method for connecting the MCU VRL pin to the external VRL source:

- **MPB/MPFB** – connect via the MPFB logic analyzer connector (refer to Chapter 4 for the appropriate logic analyzer pin).
- **MPB/MMDS1632** – connect via the VRL pin of the target MCU socket.
- **MPB/Target System** – connect via the VRL pin of the target system MAPI bus.

Alternately, you may remove the jumper and wire-wrap directly to W4 pin 2. Connecting directly to pin 2 is an option regardless of the configuration.

W4

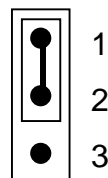

2.2.5 VSSA Insertion Point (E1)

Insertion point E1 is a plate through hole that lets you connect an external ground to the MPB VSSA pin (refer to paragraph 2.2.2). Insert an external ground wire in E1 and solder it into the plate through hole.

NOTE

Insertion point E1 is not populated by the factory.

2.3 MEVB CONFIGURATION

The MEVB contains:

- MPB – MCU-device-specific board that defines the MCU to be evaluated.
- M68MPFB1632 Modular Platform Board (MPFB) – which provides the interface connections to the host computer, logic analyzer connections, and the platform for installing the MPB. For more information about the MPFB and MEVB system connections refer to the M68MPFB1632 Modular Platform Board User's Manual, M68MPFB1632/D. Chapter 3 of this manual contains information to help you get started using your MEVB.

CAUTION

Turn OFF MPFB power when installing the MPB on the MPFB or removing the MPB from the MPFB. Sudden power surges could damage MEVB integrated circuits.

To install the MPB on the MPFB (refer to Figure 2-2):

1. Inspect all connectors for bent or damaged pins.
2. Align the MPB reference mark with the MPFB reference mark.
3. Rotate the MPB until the four MAPI bus connectors on its bottom mate with the MAPI bus connectors on the top of the MPFB. (There is only one way to connect the MPB and the MPFB.)
4. Firmly press the MPB onto the MPFB.

CAUTION

Support the bottom side of MPFB when installing the MPB on the MPFB. Excessive flexing of the MPFB could damage the printed circuit.

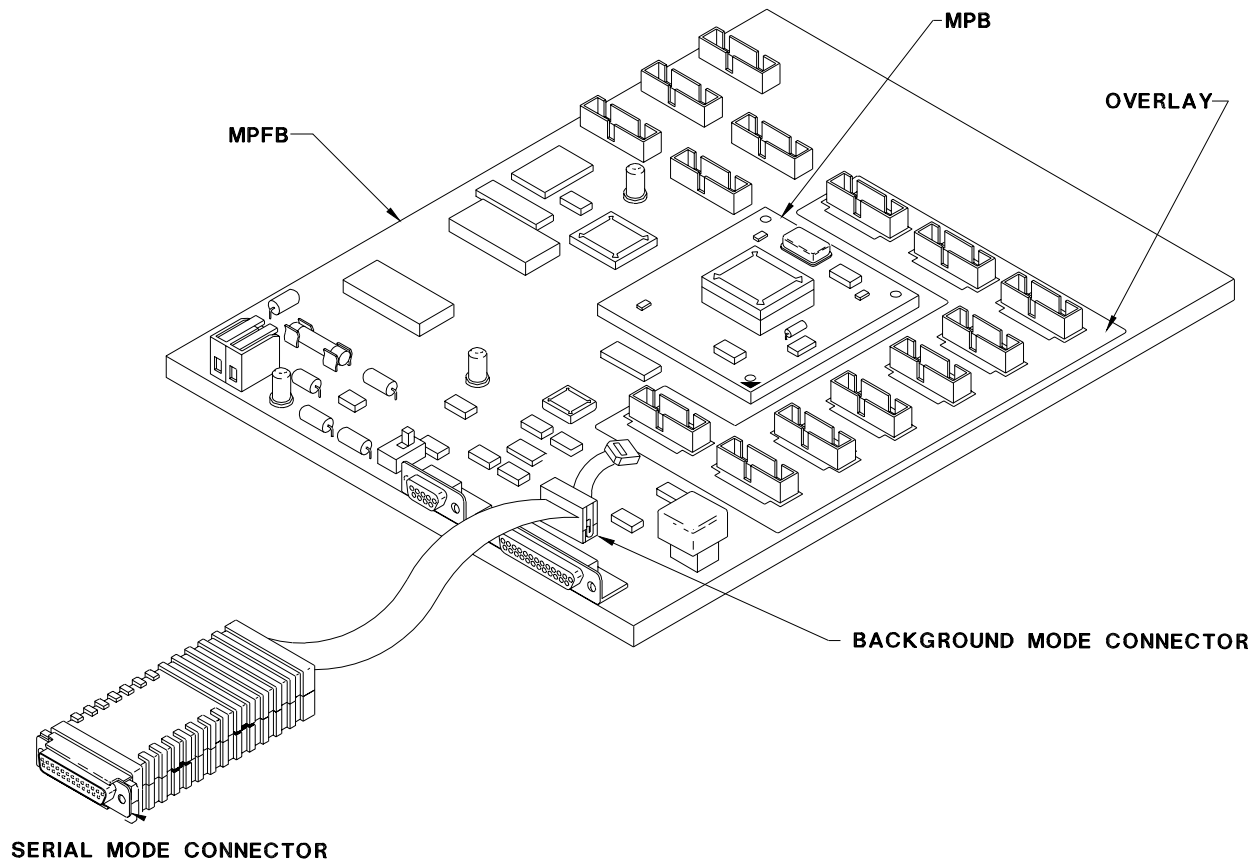

Figure 2-2. MPB – MPFB Interconnection (with SDI interface connector)

After you have installed the MPB, install the plastic overlay on the MPFB: place the overlay over logic analyzer connectors J12 through J20 and press down. Holes in the overlay slide down over plastic clips on the MPFB. These clips hold the overlay in place.

2.4 ACTIVE PROBE CONFIGURATION

The M68MMDS1632 Motorola Modular Development System (MMDS) consists of the station module and an active probe. The active probe consists of a three board set, two cables, and a box:

- MPB – MCU-device-specific board that defines the MCU to be evaluated.
- Enhanced Target Control Board (TCB) – the interface between the MPB, target system, and the station module. The TCB must be purchased separately. For more information about the TCB refer to the MMDS1632 Motorola Modular Development System User's Manual, MMDS1632UM/D.
- Package Personality Board (PPB) – the board that connects the active probe to the target system. The PPB must be purchased separately. For more information about the PPB refer to the appropriate PPB configuration guide.
- Active probe cables (2) – the interface between the active probe and the station module. 01-RE90340W01 REV 0 and 01-RE90341W01 REV 0 are printed on the active probe cables. The active probe cables come with the TCB. For more information about the active probe cables refer to the MMDS1632 Motorola Modular Development System User's Manual, MMDS1632UM/D.
- Active probe box – the protective enclosure for the TCB.

CAUTION

Turn off MMDS and target system power when installing or removing MMDS components. Sudden power surges could damage MMDS and target system integrated circuits.

To configure an active probe (refer to Figure 2-3):

1. Inspect all connectors for bent or damaged pins.
2. Rotate the MPB until the four MAPI bus connectors on its bottom mate with the MAPI bus connectors on the top of the TCB. (There is only one way to connect the MPB and the TCB.) Firmly press the MPB and the TCB together.
3. Rotate the PPB until the four MAPI bus connectors on its top mate with the MAPI bus connectors on the bottom of the TCB. (There is only one way to connect the PPB and the TCB.) Firmly press the PPB and the TCB together.

4. Connect one end of the 01-RE90341W01 REV 0 active probe cable to connector P6 on the MMDS control board; connect the other end to connector J6 on the TCB. Connect one end of the 01-RE90340W01 REV 0 active probe cable to connector P5 on the MMDS control board; connect the other end to connector J5 on the TCB. Secure the connector clamps on TCB connectors J5 and J6.

The active probe is now ready to connect to the target system (refer to the PPB configuration guide for information on connecting the active probe to the target system.)

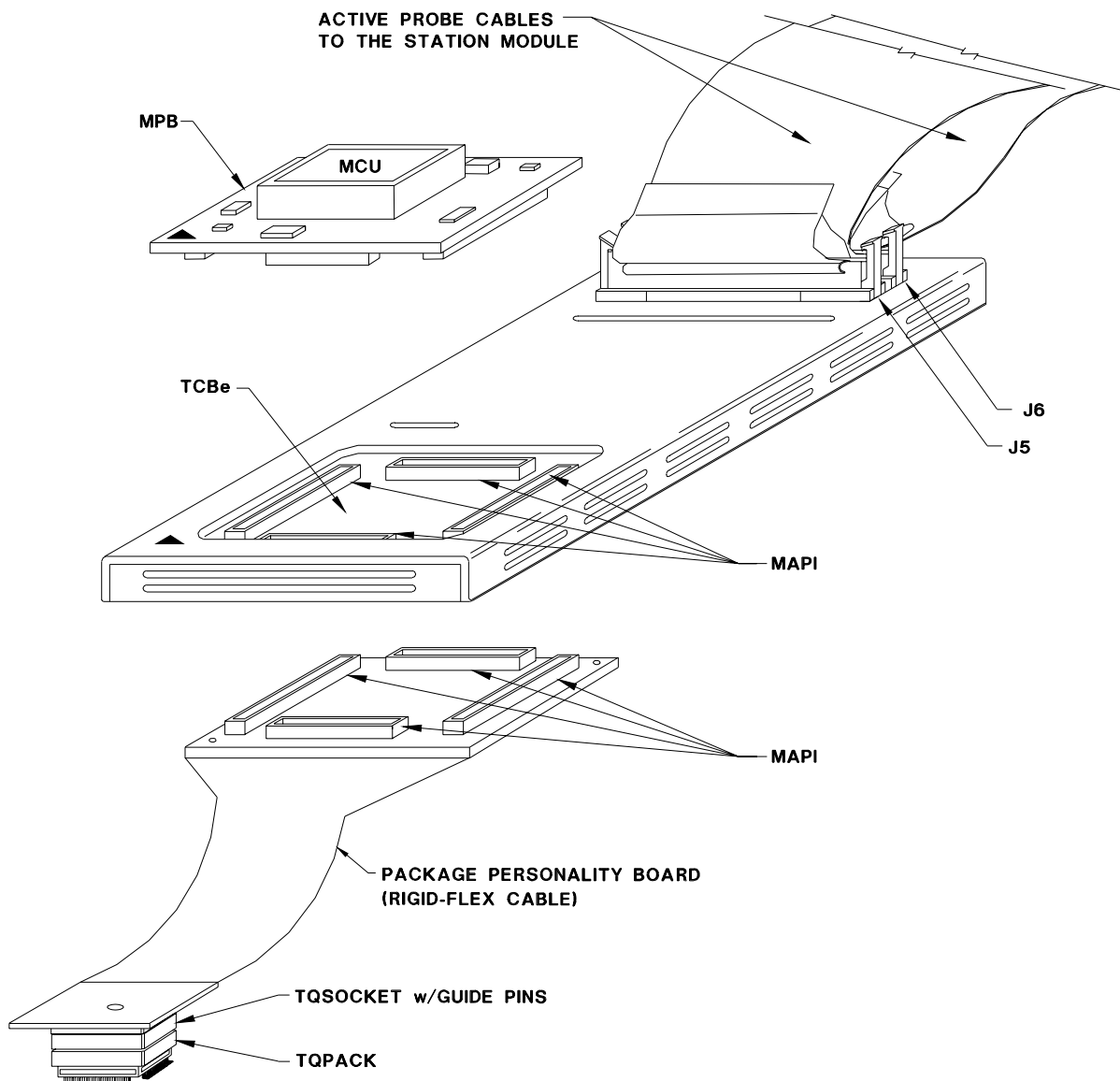

Figure 2-3. Active Probe Interconnection (with Active Probe Box)



CHAPTER 3

MEVB QUICK START GUIDE

3.1 INTRODUCTION

This quick start guide is intended for the user who may not be familiar with Motorola's development tools. This chapter explains the MEVB hardware and software set-up for M68MEVB16Z1 operation. Hardware set-up consists of configuring the MPB and MPFB jumper headers; software set-up consists of installing and running the appropriate macro script file within the debugger.

For the purpose of this quick start guide the MPB jumper headers should be configured in their default positions. Chapter 2 of this manual contains the default jumper header settings for the MPB.

3.2 CONFIGURING THE MPFB

The MPFB includes jumper-selectable options such as chip select usage, memory type selection and memory size selection for the pseudo ROM sockets, and reset data control.

NOTE

The MPFB must be configured for the specific MPB. Paragraph 3.2.2 provides a configuration for basic MPFB operation. For a detailed description of the MPFB jumper header selections refer to the M68MPFB Modular Platform Board User's Manual, M68MPFBUM/D.

3.2.1 MPFB Memory Devices

Pseudo ROM refers to memory locations U2 & U4. The two pseudo ROM sockets are generic memory sockets that accept a variety of RAM, EPROM, or EEPROM devices. The pseudo ROM sockets, as shipped from the factory, contain two 32K x 8 RAM devices. These memories are 28-pin package devices.

3.2.2 MPFB Jumper Headers

Configure your MPFB jumper headers per the instructions in Table 3-1. Table 3-1 contains information exclusively intended for quick start and ignores the other jumper headers.

Table 3-1. MPFB Quick Start Jumper Header Configuration











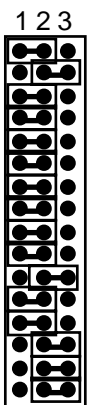
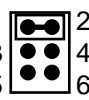

Jumper Header	Type	Description
W2		Install a jumper on pins 1 and 2 to configure pin 1 of the memory devices in the pseudo ROM sockets (U2 & U4) as a standard address line.
W3		Install a jumper on pins 1 and 2 to indicate that the memory devices in the pseudo ROM sockets (U2 & U4) have 28 pins.
W4		Install a jumper on pins 1 and 2 to set the pseudo ROM port size (memory data width) as word.
W5		Install a jumper on pins 2 and 3 to enable the PRU.
W6		W6 selects the MCU operation mode. Each 3-pin jumper header set corresponds to an MCU data line. While the reset pin is low, the reset data values are driven on the data bus (D0 – D15). (The MEVB reset data circuit is open drain; a high state is provided via a pull-up resistor.) Each reset data line may be set high (H) or low (L). Consult the appropriate MCU user's manual, data book, or technical summary for reset data information.
W10		Install a jumper on pins 1 and 2 to indicate that RAM is installed in the pseudo ROM sockets (U2 & U4).
W12		Install a jumper on pins 3 and 4 to indicate that the two devices installed in the pseudo ROM sockets (U2 & U4) are 32K x 8.

Table 3-1. MPFB Quick Start Jumper Header Configuration (continued)

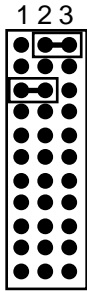
Jumper Header	Type	Description
W14		<p>Jumper header W14 selects the MCU signal for the memory devices in the fast RAM sockets (U9 & U10) and pseudo ROM sockets (U2 & U4). Pins 1 and 2 select the MCU chip select for the memory devices in the fast RAM sockets. Pins 2 and 3 of jumper header W14 select the chip select for the memory devices in the pseudo ROM sockets.</p> <p>Jumper installed on CSBOOT pins 2 and 3 (factory default); use CSBOOT as the memory device chip enable for memory devices in the pseudo ROM sockets.</p>
W16		No jumper installed; the MCU MODCLK signal is pulled high (logic 1) via a resistor during reset.
W17		No jumper installed; the BERR signal is pulled high (logic 1) via a resistor during reset.
W18		Install a jumper on pins 1 and 2 for unrestricted writes to the memory devices in the pseudo ROM sockets (U2 & U4).
W19		Install a jumper on pins 1 and 2 to ground the A19 signal to the MPFB memory arrays.
W22		Install a jumper on pins 2 and 3 to select the evaluation MCU (on the MPB) as an M68HC16 MCU device.

3.3 MEVB INSTALLATION INSTRUCTIONS

MEVB installation requires a user-supplied power supply and host computer. The host computer must have a parallel port and run MS-DOS, as required by ICD16. The following paragraphs explain MPFB connections. Refer to Chapter 2 for instructions to connect the MPB and MPFB.

3.3.1 Power Supply – MPFB Connection

Use MPFB connector J5 to connect a user-supplied power supply to the MEVB. Contact 1 is ground; black lever. Contact 2 is VDD (+5 volts); red lever. Use 20 or 22 AWG wire for power connections. For each wire, trim back the insulation 1/4 in. (.635 cm), lift the appropriate lever of J5 to release tension on the contacts, then insert the bare wire into J5 and close the lever. The MEVB requires a +5Vdc @ 1.0 amp power supply for operation. A 1.5 amp fuse is installed on the MPFB +5Vdc power supply input line.

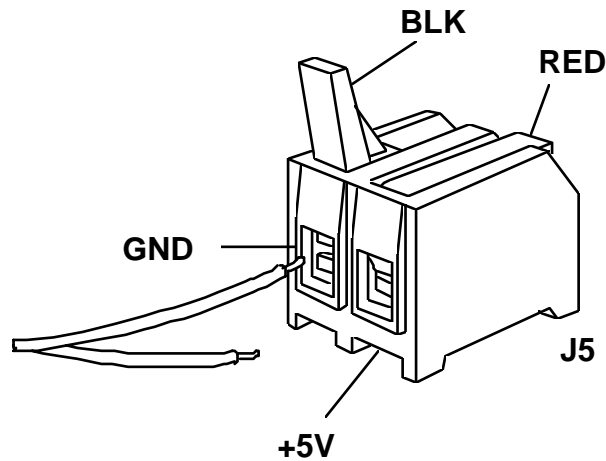

CAUTIONS

Do not use wire larger than 20 AWG in connector J5. Such wire could damage the connector.

Turn off MEVB power when installing or removing the MPB from the MPFB. Sudden power surges could damage MEVB integrated circuits.

3.3.2 Personal Computer – BDM Connection

Personal computer communication with the MEVB requires background debug mode (BDM) hardware. Connect your BDM hardware between your computer's I/O port and the BDM header on the MPFB (MPFB connector J6). The drawing below shows signal assignments for connector J6. For additional information about your BDM software/hardware, including debugging and assembly information, see the appropriate user's manual.

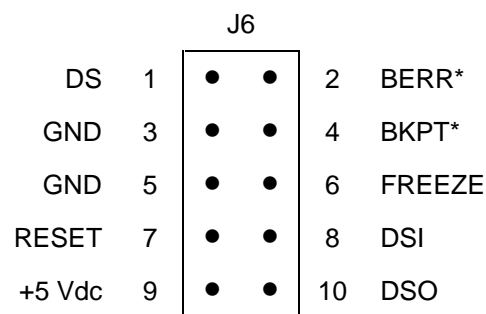

3.4 SOFTWARE INSTALLATION AND MCU INITIALIZATION

After you have set up the MEVB hardware you must install the software on your computer. Follow the installation procedure in the appropriate software operations manual.

The MCU must be initialized before the MEVB will function. The following is one possible initialization for the MPB376. You may adapt this example to your debugger. This initialization enables the maximum system clock frequency and disables the software watchdog while enabling the bus monitor. CSBOOT is set to zero-wait state and the block size set to 64K starting at \$00000. The SRAM is enabled to reside at \$10000 with the stack pointer initialized at \$103FE and the instruction pointer (IP) initialized to \$00200 (PK=0, IP=200).

Load your program at address \$00200.

Below is the MPBZ1.ICD initialization macro program listing.

```

symbol SIMCR FFA00
symbol SYNCR FFA04
symbol CSBARBT FFA48
symbol CSORBT FFA4A
symbol START 00200
dmmw SIMCR 40CF          Set module mapping to $FFF000-$FFFFFF
dmmw SYNCR 7F           Set system clock frequency to 16.78 MHz
watchdog                Disable the watchdog timer
dmmw CSBARBT 0003      Change CSBOOT block size to 64K
dmmw CSORBT 7830      Change wait state to zero
mdf6 START            Display program in PMM window
pk=0                  Initialize CPU registers
a=AA
b=BB
e=0000
ix=0000
iy=0000
iz=0000
hr=0000
ir=0000
k=0000
sp=03fe              Initialize the stack pointer
sk=1
symbol RAMBAH FFB04
symbol RAMMCR FFB00
dmmw RAMBAH 0001      Set SRAM base address
dmmw RAMMCR 00       Turn on SRAM
dmm1 10000 4D6F746F  Check SRAM: Write Motorola 68HC16 Advanced MCUs
dmm1 10004 726F6C61
dmm1 10008 20363848
dmm1 1000C 43313620
dmm1 10010 41647661
dmm1 10014 6E636564
dmm1 10018 20204D43
dmm1 1001C 55732020
dmm1 10020 36384843
mdf3 10000           Display SRAM in DMM window
ip=START            Start entering your program here

```

CHAPTER 4

MEVB SUPPORT INFORMATION

4.1 INTRODUCTION

This chapter's information is pertains to using the MPB in an MEVB (the MPB installed on a MPFB). Signals on the MPFB logic analyzer connectors are defined by the MPB type.

4.2 LOGIC ANALYZER CONNECTOR SIGNALS

The tables of this chapter describe MPFB logic analyzer connector signals if you install an M68MPB16Z1 on the MPFB. The signal descriptions on J12 – J20 are the logic analyzer pin-outs on the plastic overlay supplied with the MPB.

NOTE

The signal descriptions in the following tables are for quick reference only. The MC68HC16Z1 User's Manual, MC68HC16Z1UM/AD, contains a complete description of the MC68HC16Z1 MCU signals.

Table 4-1. Logic Analyzer Connector J7 Pin Assignments

Pin	Mnemonic	Signal
1, 2	SPARE	No connection
3	OE(ALL)	I/O PRU OUTPUT ENABLE – Input, active high; when low disables <i>all</i> PRU outputs.
4 – 11	PEPAR7 – PEPAR0	PEPAR OUTPUTS – Output signals that show the <i>complement</i> (negated contents) of the PEPAR register.
12 – 19	PE7 – PE0	PORT E I/O SIGNALS – PRU replacement of the port E function.
20	GND	GROUND

Table 4-2. Logic Analyzer Connector J8 Pin Assignments

Pin	Mnemonic	Signal
1, 2	SPARE	No connection
3	OE(ABG)	I/O PRU OUTPUT ENABLE – Input, active high; when low disables port A, port B, and port G outputs.
4 – 11	PA7 – PA0	PORT A I/O SIGNALS – PRU replacement of the port A function.
12 – 19	PB7 – PB0	PORT B I/O SIGNALS – PRU replacement of the port B function.
20	GND	GROUND

Table 4-3. Logic Analyzer Connector J9 Pin Assignments

Pin	Mnemonic	Signal
1, 2	SPARE	No connection
3	OE(H)	I/O PRU OUTPUT ENABLE – Input, active high; when low disables the port H outputs.
4 – 11	PH7 – PH0	PORT H I/O SIGNALS – PRU replacement of the port H function.
12 – 19	PG7 – PG0	PORT G I/O SIGNALS – PRU replacement of the port G function.
20	GND	GROUND

Table 4-4. Logic Analyzer Connector J10 Pin Assignments

Pin	Mnemonic	Signal
1	+5V	+5 VDC POWER – Input voltage (+5Vdc @ 1.0 A) used by the MEVB logic circuits. (To make this pin a no connection, remove the jumper from jumper header W9 on the MPFB.)
2	SPARE	No connection
3	AS	ADDRESS STROBE – Active-low output signal that indicates a valid address is on the address bus.
4 – 19	A15 – A0	ADDRESS BUS BITS 15 – 0 – Sixteen bits of the 24-bit address bus.
20	GND	GROUND

Table 4-5. Logic Analyzer Connector J11 Pin Assignments

Pin	Mnemonic	Signal
1	+5V	+5 VDC POWER – Input voltage (+5Vdc @ 1.0 A) used by the MEVB logic circuits. (To make this pin a no connection, remove the jumper from the jumper header W9 on the MPFB.)
2	SPARE	No connection
3	DS	DATA STROBE – Active-low output signal. During a read cycle, indicates that an external device should place valid data on the data bus. During a write cycle, indicates that valid data is on the data bus.
4 – 19	D15 – D0	DATA BUS 15 – 0 – 16 bits of the MCU bi-directional data bus lines.
20	GND	GROUND

Table 4-6. Logic Analyzer Connector J12 Pin Assignments

Pin	Mnemonic	Signal
1, 2	SPARE	No connection
3	CLKOUT	SYSTEM CLOCK OUT – Output signal that is the MCU internal system clock.
4	BERR	BUS ERROR – Active-low signal that indicates a memory access error has occurred.
5	BKPT / DSCLK	BREAKPOINT – Active-low input signal that signals a hardware breakpoint to the CPU. Development Serial Clock – Clock input signal for the background debug mode.
6	FREEZE QUOT	FREEZE – Output signal that indicates the CPU has acknowledged a breakpoint. QUOTIENT OUT – Output signal that furnishes the quotient bit of the polynomial divider for test purposes.
7	LAT-DSO / (Latched IPIPE0)	LATCHED INSTRUCTION PIPE 0 – Latched output signal of the first state of IPIPE0 for CPU16-based MCUs; indicates instruction pipeline activity.

Table 4-6. Logic Analyzer Connector J12 Pin Assignments (continued)

Pin	Mnemonic	Signal
8	LAT-DSI (Latched IPIPE1)	LATCHED INSTRUCTION PIPE 1 – Latched output signal of the first state of IPIPE1 for CPU16-based MCUs; indicates instruction pipeline activity.
9	DSO / (IPIPE0)	DEVELOPMENT SERIAL OUT – Serial data output signal for background debug mode. INSTRUCTION PIPE 0 for CPU16-based MCUs.
10	DSI / (IPIPE1)	DEVELOPMENT SERIAL IN – Serial data input signal for background debug mode. INSTRUCTION PIPE 1 for CPU16-based MCUs.
11	DSACK1	DATA AND SIZE ACKNOWLEDGE 1 – Active-low input signal that allows asynchronous data transfers and dynamic bus sizing between the MCU and external devices.
12	DSACK0	DATA AND SIZE ACKNOWLEDGE 0 – Active-low input signal that allows asynchronous data transfers and dynamic bus sizing between the MCU and external devices.
13	FC2 / CS5	FUNCTION CODE 2 – Output signal that identifies the processor state and address space of the current bus cycle. CHIP SELECT 5 – Output signal that selects peripheral or memory devices at programmed addresses.
14	FC1 / CS4	FUNCTION CODE 1 – Output signal that identifies the processor state and address space of the current bus cycle. CHIP SELECT 4 – Output signal that selects peripheral or memory devices at programmed addresses.
15	FC0 / CS3	FUNCTION CODE 0 – Output signal that identifies the processor state and address space of the current bus cycle. CHIP SELECT 3 – Output signal that selects peripheral or memory devices at programmed addresses.
16	SIZ1	TRANSFER SIZE – Output signal that indicate the number of bytes still to be transferred during this cycle.

Table 4-6. Logic Analyzer Connector J12 Pin Assignments (continued)

Pin	Mnemonic	Signal
17	SIZ0	TRANSFER SIZE – Output signal that indicate the number of bytes still to be transferred during this cycle.
18	R/W	READ/WRITE – Output signal that indicates the direction of data transfer on the bus.
19	BGACK /	BUS GRANT ACKNOWLEDGE – Active-low input signal that indicates an external device has assumed bus mastership.
	CS2	CHIP SELECT 2 – Output signal that selects peripheral or memory devices at programmed addresses.
20	GND	GROUND

Table 4-7. Logic Analyzer Connector J13 Pin Assignments

Pin	Mnemonic	Signal
1	+5V	+5 VDC POWER – Input voltage (+5Vdc @ 1.0 A) used by the MEVB logic circuits. (To make this pin a no connection, remove the jumper from jumper header W21 on the MPFB.)
2	SPARE	No connection
3	DSACK1	DATA AND SIZE ACKNOWLEDGE 1 – Active-low input signal that allows asynchronous data transfers and dynamic bus sizing between the MCU and external devices.
4	AVEC	AUTOVECTOR – Active-low input signal that requests an automatic vector during interrupt acknowledge.
5	HALT	HALT – Active-low input/output signal that suspends external bus activity, to request a retry when used with BERR, or for single-step operation.
6	AS	ADDRESS STROBE – Active-low output signal that indicates a valid address is on the address bus.
7	DS	DATA STROBE – Active-low output signal. During a read cycle, indicates that an external device should place valid data on the data bus. During a write cycle, indicates that valid data is on the data bus.

Table 4-7. Logic Analyzer Connector J13 Pin Assignments (continued)

Pin	Mnemonic	Signal
8	BR /	BUS REQUEST – Active-low input signal that indicates an external device requires bus mastership.
	CS0	CHIP SELECT 0 – Output signal that selects peripheral or memory devices at programmed addresses.
9	BG /	BUS GRANT – Active-low output signal that indicates the MCU has relinquished the bus.
	CS1	CHIP SELECT 1 – Output signal that selects peripheral or memory devices at programmed addresses.
10	CSBOOT	BOOT CHIP SELECT – An active-low output chip select for external boot startup ROM
11	CLKOUT	SYSTEM CLOCK OUTPUT – MCU internal clock output signal.
12	A23 /	ADDRESS BUS BIT 23 – One bit of the 24-bit address bus.
	CS10	CHIP SELECT 10 – Output signal that selects peripheral or memory devices at programmed addresses.
	ECLK	EXTERNAL CLOCK – M6800 bus clock output.
13	A22 /	ADDRESS BUS BIT 22 – One bit of the 24-bit address bus.
	CS9	CHIP SELECT 9 – Output signal that selects peripheral or memory devices at programmed addresses.
14	A21 /	ADDRESS BUS BIT 21 – One bit of the 24-bit address bus.
	CS8	CHIP SELECT 8 – Output signal that selects peripheral or memory devices at programmed addresses.
15	A20 /	ADDRESS BUS BIT 20 – One bit of the 24-bit address bus.
	CS7	CHIP SELECT 7 – Output signal that selects peripheral or memory devices at programmed addresses.

Table 4-7. Logic Analyzer Connector J13 Pin Assignments (continued)

Pin	Mnemonic	Signal
16	A19 / CS6	ADDRESS BUS BIT 19 – One bit of the 24-bit address bus. CHIP SELECT 6 – Output signal that selects peripheral or memory devices at programmed addresses.
17 – 19	A18 – A16	ADDRESS BUS 18 – 16 – Three bits of the 24-bit address bus.
20	GND	GROUND

Table 4-8. Logic Analyzer Connector J14 Pin Assignments

Pin	Mnemonic	Signal
1, 2	SPARE	No connection
3	DSACK0	DATA AND SIZE ACKNOWLEDGE 0 – Active-low input signal that allows asynchronous data transfers and dynamic bus sizing between the MCU and external devices.
4	MODCLK	CLOCK MODE SELECT – Input signal that configures the MCU internal clock at reset.
5	TSTME / TSC	TEST MODE ENABLE – Input signal that enables hardware for test mode. THREE STATE CONTROL – When TSC is logic high, this input signal forces all output drivers to a high-impedance state.
6	RESET	RESET – Active-low, bi-directional signal to start a system reset.
7	PULL-UP	Not connected; pulled high through a resistor on the MPB.
8	SPARE	No connection
9 – 15	GND	GROUND
16 – 19	SPARE	No connection
20	GND	GROUND

Table 4-9. Logic Analyzer Connector J15 Pin Assignments

Pin	Mnemonic	Signal
1 – 3	SPARE	No connection
4 – 13	GND	GROUND
14	PCLK	AUXILIARY TIMER CLOCK INPUT – External input clock source for the GPT.
15	PWMB	PULSE WIDTH MODULATION B – Repetitive output signals whose high time to low time ratio can be controlled by the CPU.
16	PWMA	PULSE WIDTH MODULATION A – Repetitive output signals whose high time to low time ratio can be controlled by the CPU.
17	PAI	PULSE ACCUMULATOR INPUT – Input signal that increments an 8-bit counter.
18, 19	SPARE	No connection
20	GND	GROUND

Table 4-10. Logic Analyzer Connector J16 Pin Assignments

Pin	Mnemonic	Signal
1 – 4	SPARE	No connection
5	IC1	INPUT CAPTURE 1 – Input signal that latches the contents of the GPT timer counter (TCNT) into the input capture register TIC1 when a selected edge occurs at the pin.
6	IC2	INPUT CAPTURE 2 – Input signal that latches the contents of the GPT timer counter (TCNT) into the input capture register TIC2 when a selected edge occurs at the pin.
7	IC3	INPUT CAPTURE 3 – Input signal that latches the contents of the GPT timer counter (TCNT) into the input capture register TIC3 when a selected edge occurs at the pin.
8	OC1	OUTPUT COMPARE 1 – Output signal that is generated when the GPT timer counter (TCNT) and TOC1 comparator register contain the same value.

Table 4-10. Logic Analyzer Connector J16 Pin Assignments (continued)

Pin	Mnemonic	Signal
9	OC2	OUTPUT COMPARE 2 – Output signal that is generated when the GPT timer counter (TCNT) and TOC2 comparator register contain the same value.
10	OC3	OUTPUT COMPARE 3 – Output signal that is generated when the GPT timer counter (TCNT) and TOC3 comparator register contain the same value.
11	OC4	OUTPUT COMPARE 4 – Output signal that is generated when the GPT timer counter (TCNT) and TOC4 comparator register contain the same value.
12	IC4 /	INPUT CAPTURE 4 – Input signal that latches the contents of the GPT timer counter (TCNT) into the input capture register TIC4 when a selected edge occurs at the pin.
	OC5	OUTPUT COMPARE 5 – Output signal that is generated when the GPT timer counter (TCNT) and TOC5 comparator register contain the same value.
13 – 19	SPARE	No connection
20	GND	GROUND

Table 4-11. Logic Analyzer Connector J17 Pin Assignments

Pin	Mnemonic	Signal
1 – 4	SPARE	No connection
5	GND	GROUND
6	TXD	TRANSMIT DATA – Serial data output line to serial communication interface.
7	RXD	RECEIVE DATA – Serial data input line to serial communication interface.
8 – 10	PCS3 – PCS1	QSPI peripheral chip selects
11	PCS0 /	PERIPHERAL CHIP SELECT 0 – Active-low output SPI peripheral chip select signal.
	SS	SLAVE SELECT – Bi-directional, active-low signal that initiates serial transmission when SPI is in slave mode; causes mode fault in master mode.

Table 4-11. Logic Analyzer Connector J17 Pin Assignments (continued)

Pin	Mnemonic	Signal
12	GND	GROUND
13	SCK	SPI SERIAL CLOCK – In master mode, the clock signal from the SPI; in slave mode the clock signal to the SPI.
14	MOSI	MASTER-OUT, SLAVE-IN – Serial output from QSPI in master mode; serial input to QSPI in slave mode.
15	MISO	MASTER-IN, SLAVE-OUT – Serial input to QSPI in master mode; serial output from QSPI in slave mode.
16	GND	GROUND
17 – 19	SPARE	No connection
20	GND	GROUND

Table 4-12. Logic Analyzer Connector J18 Pin Assignments

Pin	Mnemonic	Signal
1 – 4	SPARE	No connection
5	VSSA	A/D GROUND – A/D ground reference.
6 – 13	AN0 – AN7	ANALOG TO DIGITAL CONVERSION 0 -7 – Analog input lines to the MCU device.
14	VRH	VOLTAGE REFERENCE HIGH – Input reference supply voltage (high) line (must set jumper on the MPB).
15	VRL	VOLTAGE REFERENCE LOW – Input reference supply voltage (low) line (must set jumper on the MPB).
16	VSSA	A/D GROUND – A/D ground reference.
17 – 19	SPARE	No connection
20	VSSA	A/D GROUND – A/D ground reference.

Table 4-13. Logic Analyzer Connector J19 Pin Assignments

Pin	Mnemonic	Signal
1 – 4	SPARE	No connection
5 – 10	GND	GROUND
11, 12	IRQ7, IRQ6	TARGET INTERRUPT REQUEST 7 and 6 - Active-low input signals from the target that asynchronously provides an interrupt priority level to the CPU. IRQ1 has the lowest priority, IRQ7 has the highest.
13 – 19	SPARE	No connection
20	GND	GROUND

Table 4-14. Logic Analyzer Connector J20 Pin Assignments

Pin	Mnemonic	Signal
1 – 4	SPARE	No connection
5 – 13	GND	GROUND
14 – 18	IRQ1 – IRQ5	TARGET INTERRUPT REQUEST 1 – 5 - Active-low input signals from the target that asynchronously provides an interrupt priority level to the CPU. IRQ1 has the lowest priority, IRQ7 has the highest.
19	SPARE	No connection
20	GND	GROUND

CHAPTER 5

MAPI SUPPORT INFORMATION

5.1 INTRODUCTION

This chapter information pertains to installing the MPB on a target system. The figures in this chapter show the MAPI interface connector layout and pin assignments for MPB connectors P1, P2, P3, and P4 (Figures 5-1 through 5-5).

5.2 MAPI BUS CONNECTORS

The connectors required to interface to the MAPI bus are:

- 2 – Robinson Nugent, 2 X30 plugs, P50L-060P-AS-TGF
- 2 – Robinson Nugent, 2 X40 plugs, P50L-080P-AS-TGF

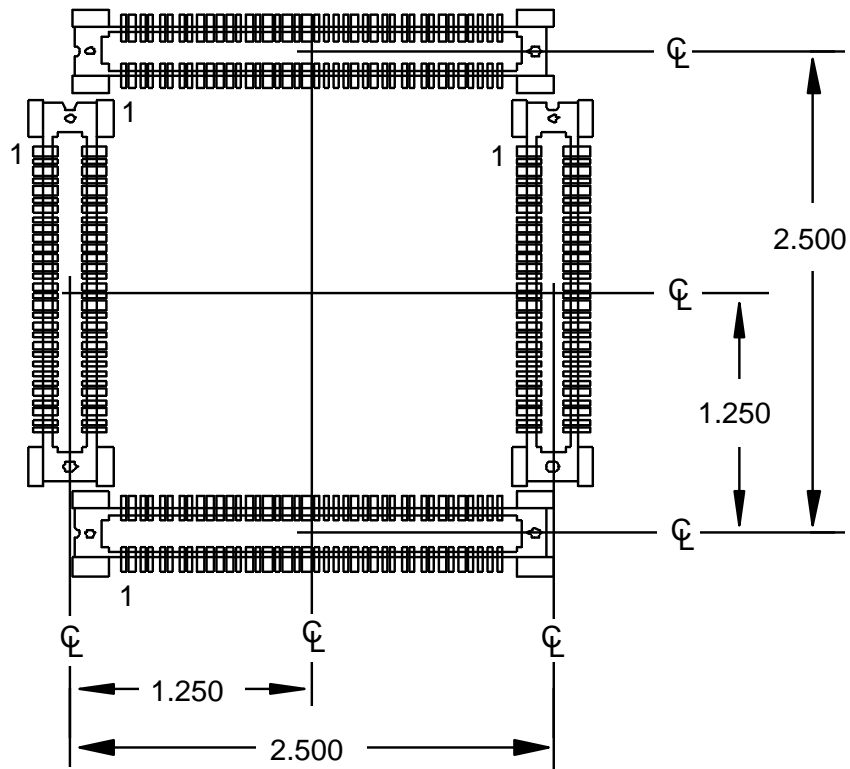

Figure 5-1. MAPI Interface Connector Layout

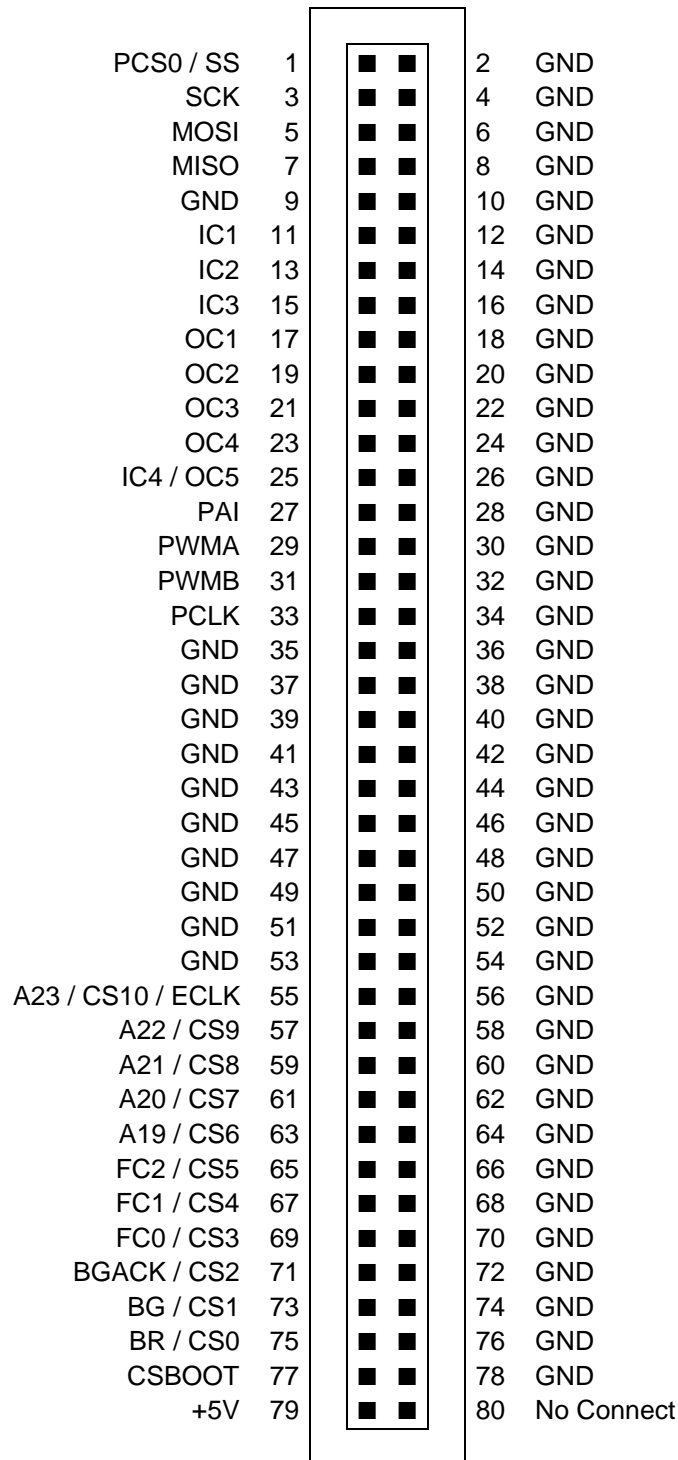

Figure 5-2. MAPI Interface Connector P1 Pin Assignments

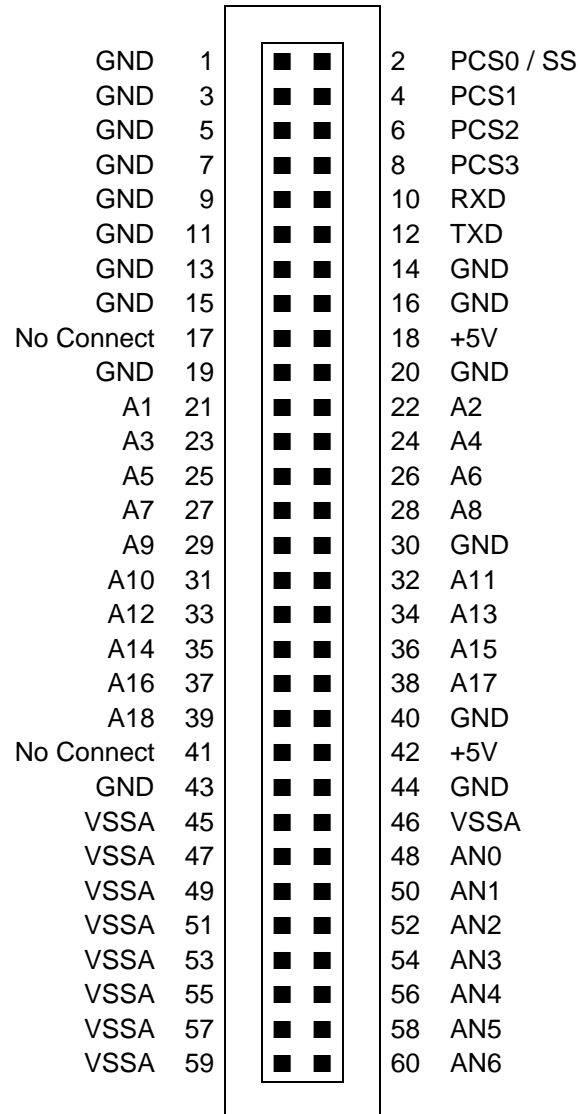

Figure 5-3. MAPI Interface Connector P2 Pin Assignments

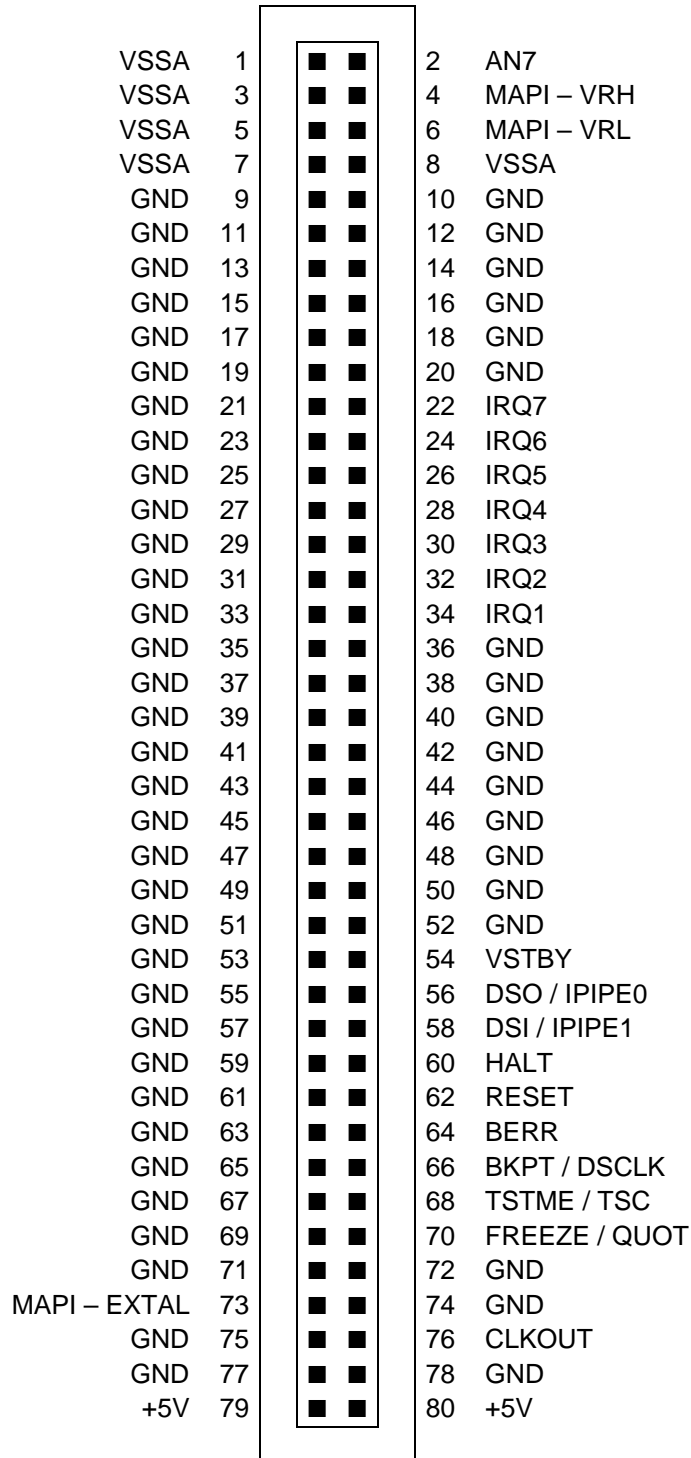

Figure 5-4. MAPI Interface Connector P3 Pin Assignments

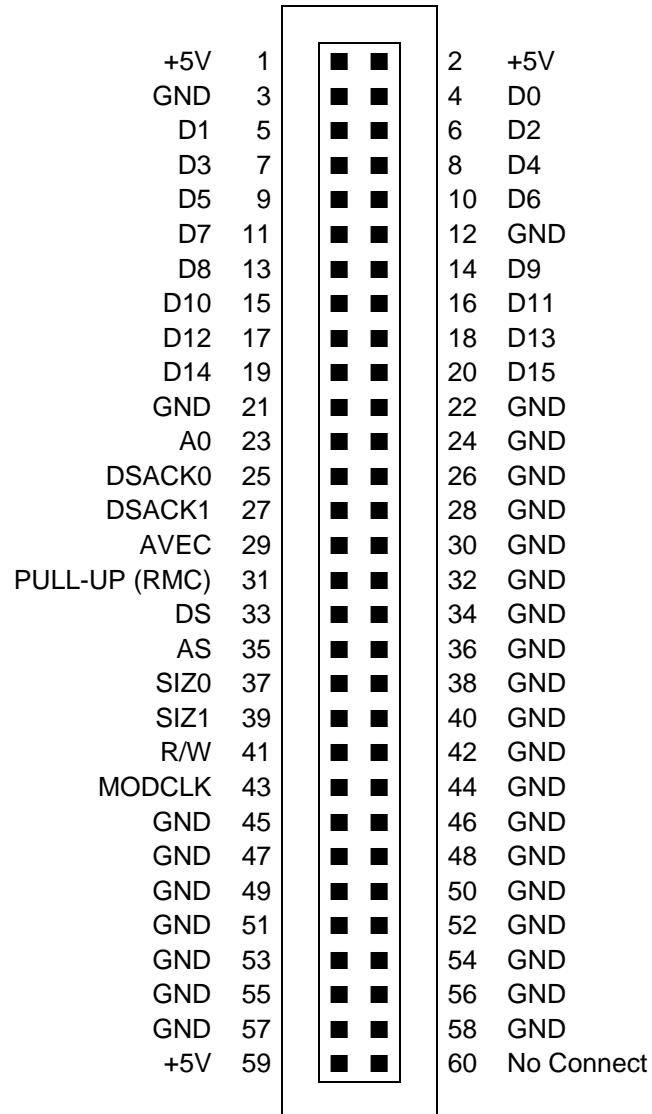

Figure 5-5. MAPI Interface Connector P4 Pin Assignments



CHAPTER 6

SCHEMATIC DIAGRAMS

6.1 INTRODUCTION

This chapter contains the M68MPB16Z1 MCU Personality Board (MPB) schematic diagrams. These schematic diagrams are for reference only and may deviate slightly from the circuits on your MPB.

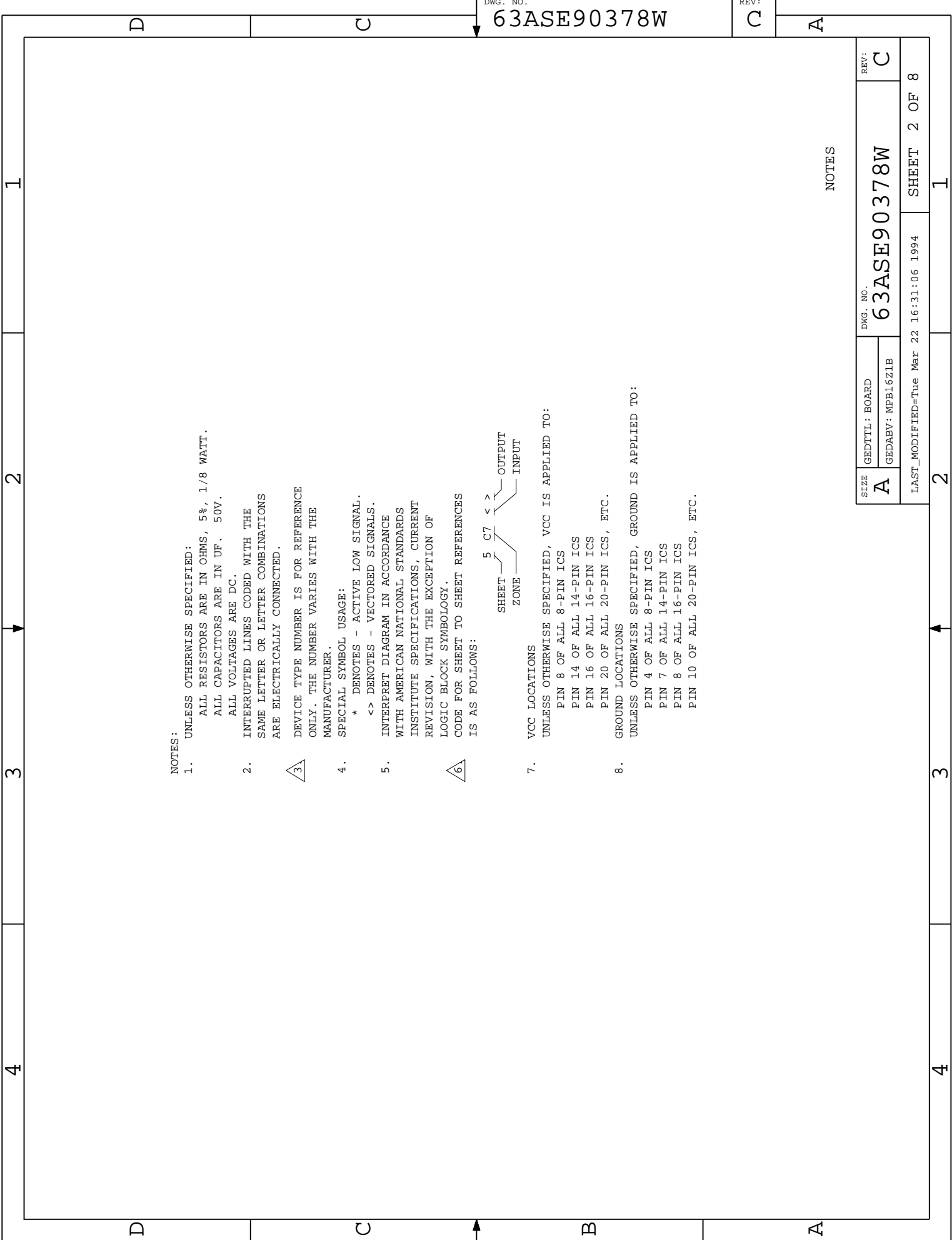

DWG. NO.

63ASE90378W

REV:

C

NOTES:

1. UNLESS OTHERWISE SPECIFIED:
 ALL RESISTORS ARE IN OHMS, 5%, 1/8 WATT.
 ALL CAPACITORS ARE IN UF. 50V.
 ALL VOLTAGES ARE DC.

2. INTERRUPTED LINES CODED WITH THE
 SAME LETTER OR LETTER COMBINATIONS
 ARE ELECTRICALLY CONNECTED.

3. DEVICE TYPE NUMBER IS FOR REFERENCE
 ONLY. THE NUMBER VARIES WITH THE
 MANUFACTURER.

4. SPECIAL SYMBOL USAGE:

* DENOTES - ACTIVE LOW SIGNAL.
 <> DENOTES - VECTORED SIGNALS.

5. INTERPRET DIAGRAM IN ACCORDANCE
 WITH AMERICAN NATIONAL STANDARDS
 INSTITUTE SPECIFICATIONS, CURRENT
 REVISION, WITH THE EXCEPTION OF
 LOGIC BLOCK SYMBOLOGY.

6. CODE FOR SHEET TO SHEET REFERENCES
 IS AS FOLLOWS:

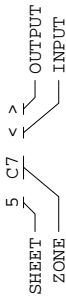

7. VCC LOCATIONS

UNLESS OTHERWISE SPECIFIED, VCC IS APPLIED TO:

- PIN 8 OF ALL 8-PIN ICS
- PIN 14 OF ALL 14-PIN ICS
- PIN 16 OF ALL 16-PIN ICS
- PIN 20 OF ALL 20-PIN ICS, ETC.

8. GROUND LOCATIONS

UNLESS OTHERWISE SPECIFIED, GROUND IS APPLIED TO:

- PIN 4 OF ALL 8-PIN ICS
- PIN 7 OF ALL 14-PIN ICS
- PIN 8 OF ALL 16-PIN ICS
- PIN 10 OF ALL 20-PIN ICS, ETC.

NOTES

SIZE	GEDTTL: BOARD	DWG. NO.	REV:
A	GEDABV: MPB1621B	63ASE90378W	C

LAST_MODIFIED=Tue Mar 22 16:31:06 1994

SHEET 2 OF 8

2

3

4

1

+5V AND GND DECOUPLING FOR VDDDE OF MCU AND OSCILLATOR

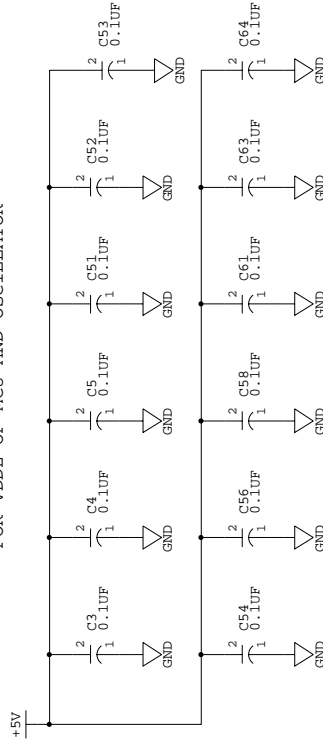

VDDI/VSSII GENERATION

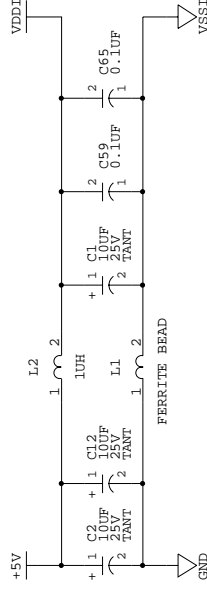

ADC MODULE

VDDA/VSSA GENERATION

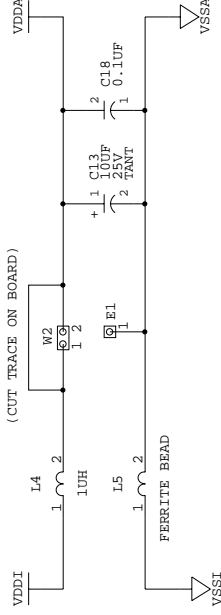

ADC MODULE

VRH & VRL SELECTION

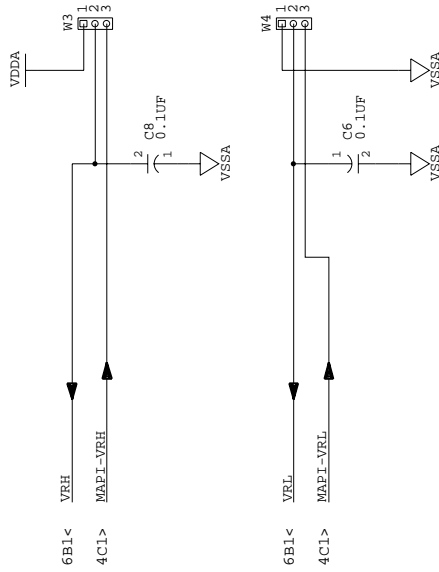

ADC MODULE

ANALOG SIGNAL FILTERS

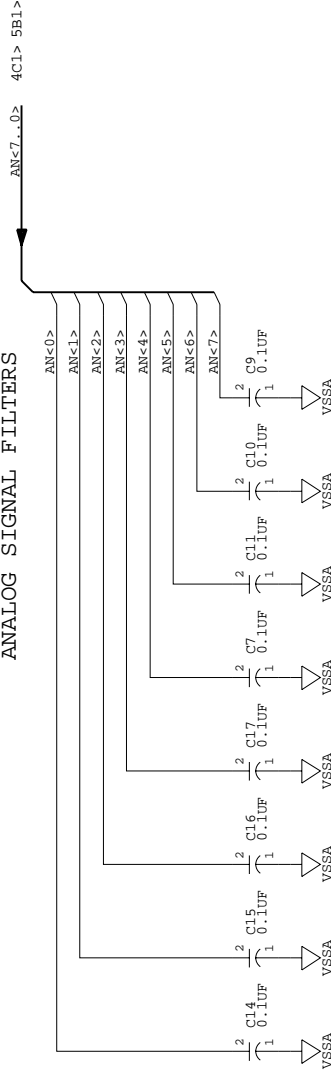

BYPASS CAPACITORS, CLEAN POWER & SIGNAL FILTERS

SIZE	GEDTTL: BOARD	DWG. NO.	REV:
A	GEDABV: MPB16Z1B	63ASE90378W	C

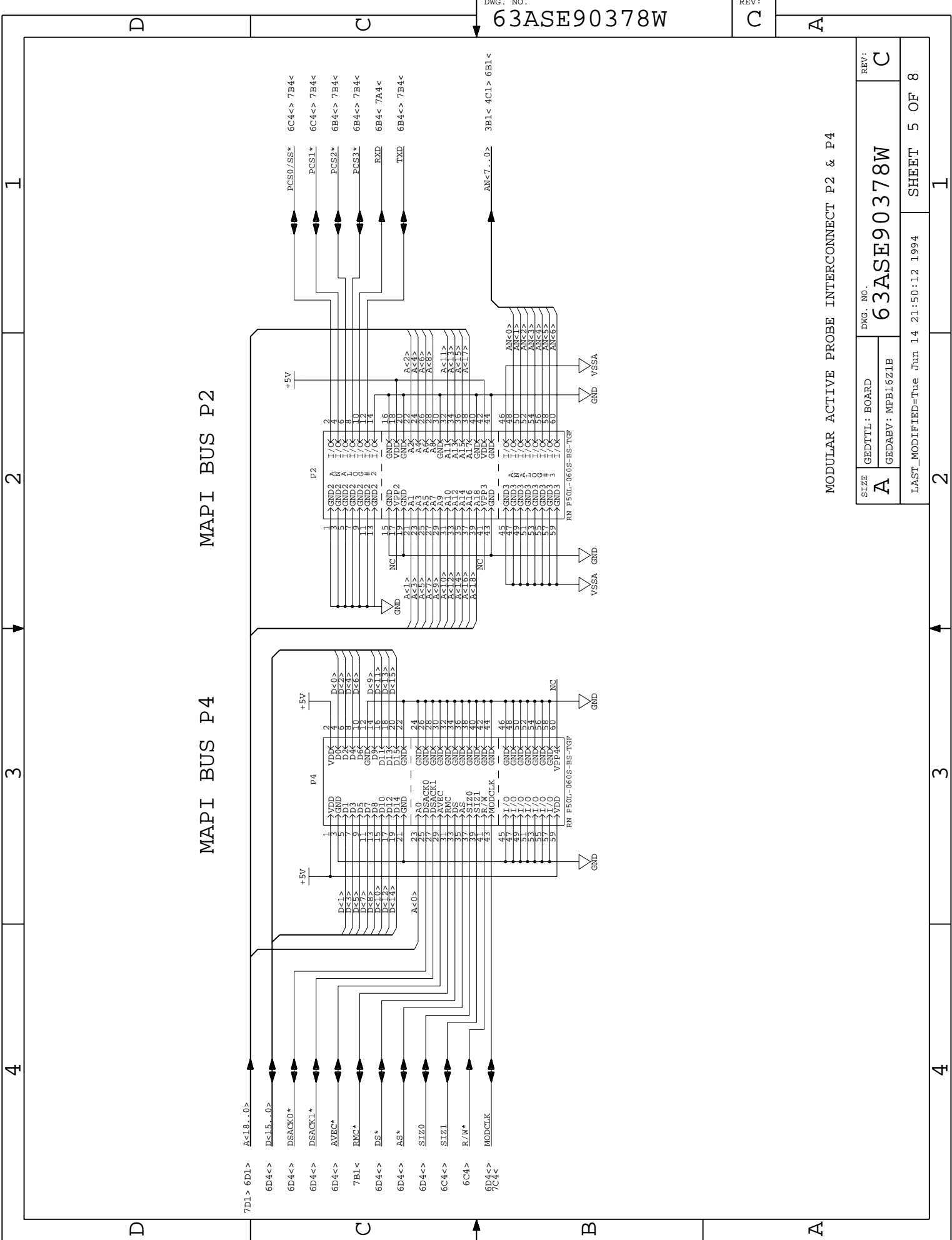

MODULAR ACTIVE PROBE INTERCONNECT P2 & P4

SIZE	GEDTTL: BOARD	DWG. NO.	REV:
A	GEDABV: MPB1621B	63ASE90378W	C

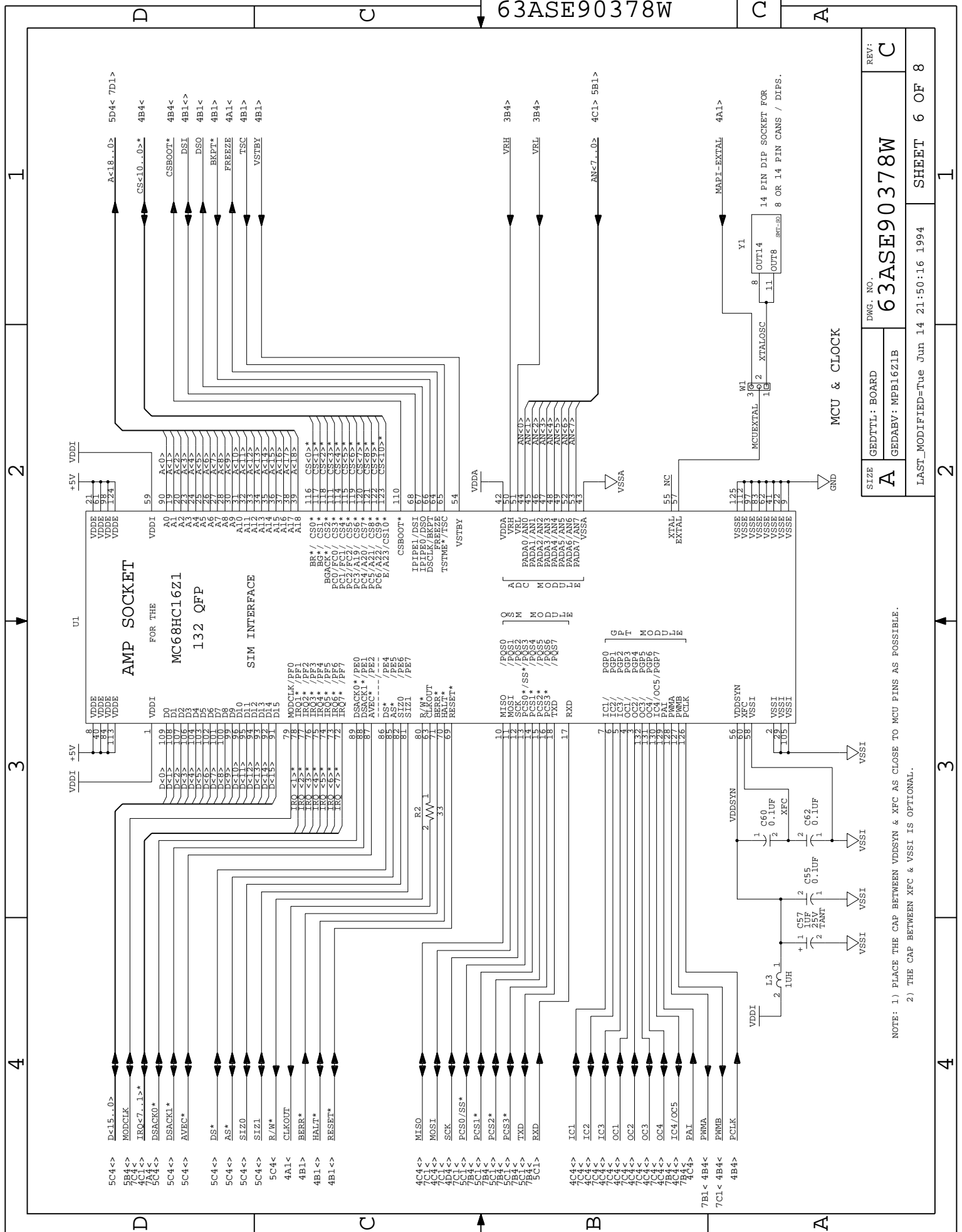

SIZE	A	GEDTTL: BOARD	DWG. NO.	63ASE90378W	REV:	C
		GEDABY: MPB16Z1B				
LAST_MODIFIED=Tue Jun 14 21:50:16 1994			SHEET 6 OF 8			

NOTE: 1) PLACE THE CAP BETWEEN VDDSYN & XFC AS CLOSE TO MCU PINS AS POSSIBLE.
 2) THE CAP BETWEEN XFC & VSSI IS OPTIONAL.

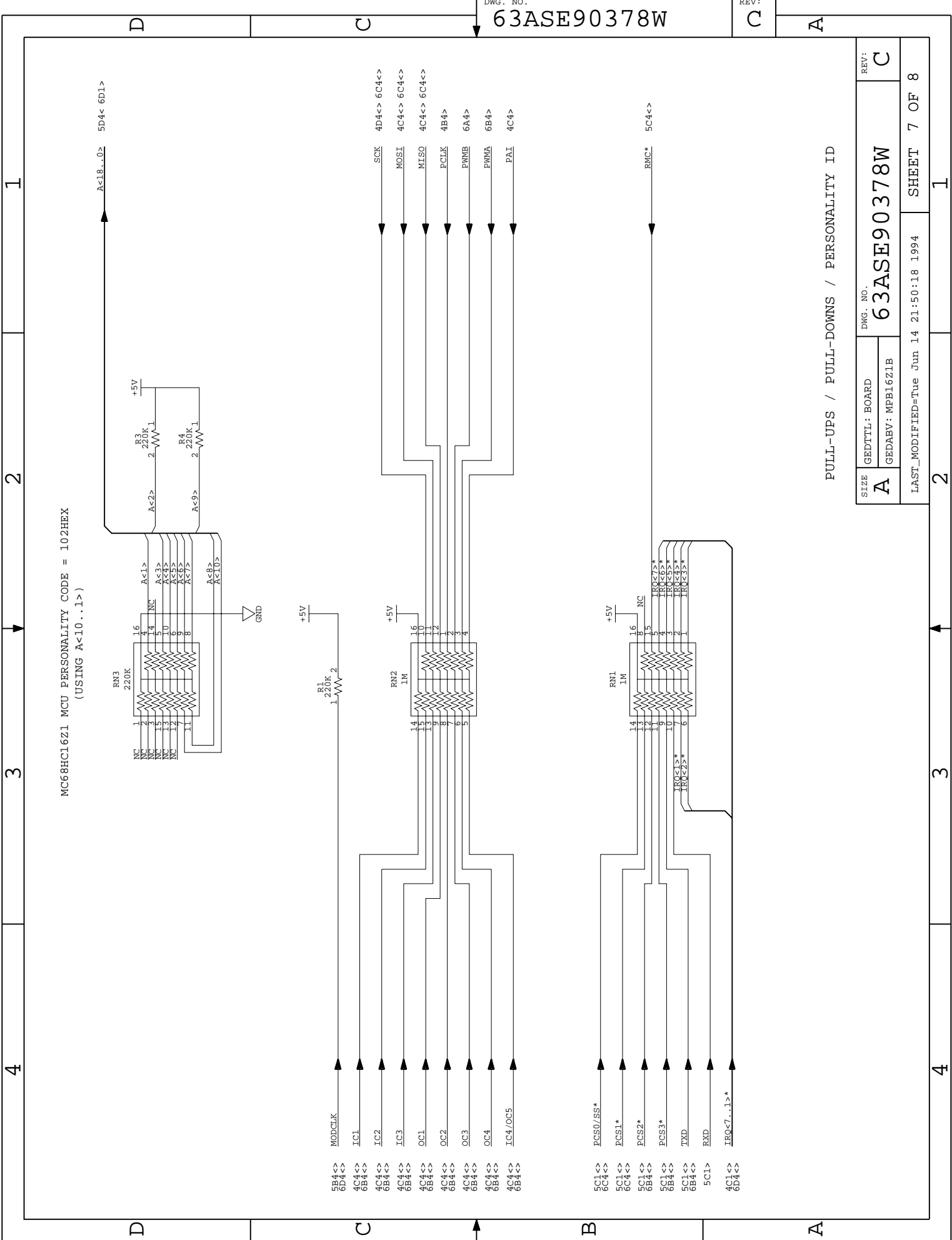

PULL-UPS / PULL-DOWNS / PERSONALITY ID

SIZE	GEDTTL: BOARD	DWG. NO.	REV:
A	GEDABV: MPB16Z1B	63ASE90378W	C

1

2

3

4

D

C

C

A

VSTBY
4B1> 6C1<

```

*** Signal Cross-Reference ***
--- for the entire design ---

A <18..0>
AN <7..0>
AS *
AVEC *
BERR *
BKPT *
CLKOUT
CS <10..0> *
CSROOT *
D <15..0>
DS *
DSACK0 *
DSACK1 *
DSI
DSO
FREEZE
HALT *
IC1
IC2
IC3
IC4/OC5
IRQ <7..1> *
MAPI-EXTAL
MAPI-VRH
MAPI-VRL
MISO
MODCLK
MOSI
OCL
OC2
OC3
OC4
PAL
PCLK
4B4> 6A4< 7C1<
PCS0/SS *
PCS1 *
PCS2 *
PCS3 *
PWMA
PWMB
R/W *
RESET *
RMC *
RXD
SCK
SIZ0
SIZ1
TSC
TXD
VRH
VRL

5D4< 6D1> 7D1>
3B1< 4C1> 5E1> 6E1<
5C4<> 6D4<>
5C4<> 6D4<>
4B1> 6C4<
4B1> 6D1<
4A1< 6C4>
4B4< 6D1<>
4B4< 6D1>
5C4<> 6D4<>
5C4<> 6D4<>
5C4<> 6D4<>
5C4<> 6D4<>
5C4<> 6D4<>
4B1<> 6D1<>
4B1<> 6D1<>
4B1< 6D1>
4A1< 6D1>
4B1<> 6C4<>
4C4<> 6B4<> 7C4<
4C4<> 6B4<> 7C4<
4C4<> 6B4<> 7C4<
4C4<> 6B4<> 7B4<
4C1<> 6D4<> 7A4<
4A1> 6A1<
3B4< 4C1>
3B4< 4C1>
4C4<> 6C4<> 7C1<
5B4<> 6D4<> 7C4<
4C4<> 6C4<> 7C1<
4C4<> 6B4<> 7C4<
4C4<> 6B4<> 7C4<
4C4<> 6B4<> 7C4<
4C4<> 6B4<> 7B4<
4C4<> 6B4<> 7B4<
4C4> 6B4< 7B1<
4B4> 6A4< 7C1<
5C1<> 6C4<> 7B4<
5C1<> 6C4<> 7B4<
5C1<> 6B4<> 7B4<
5C1<> 6B4<> 7B4<
4B4< 6B4> 7B1<
4B4< 6A4> 7C1<
5C4< 6C4>
4B1<> 6C4<>
5C4<> 7B1<
5C1> 6B4< 7A4<
4D4<> 6C4<> 7C1<
5C4<> 6D4<>
5C4<> 6C4<>
4B1> 6D1<
5C1<> 6B4<> 7B4<
3B4> 6B1<
3B4> 6E1<

```

SIGNAL CROSS REFERENCES

SIZE	GEDTTL: BOARD	DWG. NO.	REV:
A	GEDABY: MPB16Z1B	63ASE90378W	C

LAST_MODIFIED=Thu Mar 24 20:43:36 1994 SHEET 8 OF 8

1

2

3

4

D

C

B

A

