

M68HC11EVBU/D
REV 3

April 1997

M68HC11EVBU

UNIVERSAL EVALUATION BOARD

USER'S MANUAL

**Information contained in this document applies to
REVision (B) M68HC11EVBU Universal Evaluation Boards.**

© MOTOROLA Inc. 1990, 1997; All Rights Reserved

Motorola reserves the right to make changes without further notice to any products herein to improve reliability, function, or design. Motorola does not assume any liability arising out of the application or use of any product or circuit described herein; neither does it convey any license under its patent rights nor the rights of others. Motorola products are not designed, intended, or authorized for use as components in systems intended for surgical implant into the body, or other application in which the failure of the Motorola product could create a situation where personal injury or death may occur. Should Buyer purchase or use Motorola products for any such unintended or unauthorized application, Buyer shall indemnify and hold Motorola and its officers, employees, subsidiaries, affiliates, and distributors harmless against all claims, costs, damages, and expenses, and reasonable attorney fees arising out of, directly or indirectly, any claim of personal injury or death associated with such unintended or unauthorized use, even if such claim alleges that Motorola was negligent regarding the design or manufacture of the part.

Motorola and the Motorola logo are registered trademarks of Motorola Inc.

Motorola Inc. is an Equal Opportunity/Affirmative Action Employer.

IBM-PC is a registered trademark of International Business Machines Corp.

Apple, MacTerminal, MacWrite are trademarks of Apple Computer, Inc.

Macintosh is a trademark licensed to Apple Computer, Inc.

Macintosh is a trademark of MacIntosh Laboratory, Inc.

Red Ryder is a trademark of Freesoft Company

The computer program stored in the Read Only Memory of the device contains material copyrighted by Motorola Inc., first published 1990, and may be used only under a license such as the License For Computer Programs (Article 14) contained in Motorola's Terms and Conditions of Sale, Rev. 1/79.

PREFACE

Unless otherwise specified, all address references are in hexadecimal throughout this manual.

An asterisk (*) following the signal name denotes that the signal is true or valid when the signal is low.

CONTENTS

CHAPTER 1 GENERAL INFORMATION

1.1 INTRODUCTION	1-1
1.2 FEATURES	1-1
1.3 SPECIFICATIONS.....	1-2
1.4 GENERAL DESCRIPTION.....	1-2
1.5 EQUIPMENT REQUIRED	1-3
1.6 CUSTOMER SUPPORT	1-4

CHAPTER 2 HARDWARE PREPARATION AND INSTALLATION

2.1 INTRODUCTION	2-1
2.2 UNPACKING INSTRUCTIONS.....	2-1
2.3 HARDWARE PREPARATION.....	2-1
2.3.1 Input Power Select Header (J1)	2-4
2.3.2 Program Execution Select Header (J2).....	2-5
2.3.3 MCU Mode Select Headers (J3 and J4)	2-6
2.3.4 MCU Clock Reconfiguration Headers (J5 and J6).....	2-8
2.3.5 Trace Enable Header (J7)	2-9
2.3.6 SCI Reconfiguration Headers (J8 and J9).....	2-10
2.3.7 SPI Reconfiguration Headers (J10 thru J13)	2-11
2.3.8 Real-Time Clock INT* Header (J14)	2-12
2.3.9 TxD Reconfiguration Header (J15)	2-13
2.4 REAL-TIME CLOCK, RAM, SERIAL INTERFACE PERIPHERAL.....	2-14
2.4.1 Diode Jumpers (D1-D4)	2-15
2.4.2 Test Points (TP1-TP6).....	2-16
2.5 WIRE-WRAP AREA	2-17
2.6 INSTALLATION INSTRUCTIONS.....	2-20
2.6.1 Power Supply – EVBU Interconnection.....	2-20
2.6.2 Terminal – EVBU Interconnection.....	2-22
2.6.3 External Equipment – MCU Interconnection	2-25
2.6.4 Wire-Wrap Area – MCU Interconnection	2-25
2.6.5 MCU A/D Converter Circuitry Modifications.....	2-28

CHAPTER 3 MONITOR PROGRAM

3.1 INTRODUCTION	3-1
3.2 PROGRAM DESCRIPTION.....	3-1
3.2.1 Initialization.....	3-1
3.2.2 Command Interpreter.....	3-2
3.2.3 I/O Routines.....	3-2
3.2.4 Utility Subroutines.....	3-3
3.2.5 Command Table.....	3-5
3.3 INTERRUPT VECTORS	3-5

CHAPTER 4 OPERATING INSTRUCTIONS

4.1 INTRODUCTION	4-1
4.2 CONTROL SWITCH	4-1
4.3 LIMITATIONS.....	4-1
4.4 OPERATING PROCEDURES.....	4-3
4.4.1 Debugging/Evaluation	4-3
4.4.2 Alternate Baud Rates	4-3
4.4.3 Monitor Program	4-5
4.5 COMMAND LINE FORMAT	4-6
4.6 MONITOR COMMANDS	4-7
4.6.1 Assembler/Disassembler.....	4-10
4.6.4 Erase All EEPROM Locations	4-15
4.6.6 Execute Subroutine.....	4-17
4.6.7 Execute Program.....	4-19
4.6.8 Help.....	4-20
4.6.9 Load S-Records.....	4-21
4.6.10 Memory Display	4-22
4.6.11 Memory Modify.....	4-24
4.6.12 Move Memory	4-26
4.6.13 Proceed/Continue.....	4-27
4.6.14 Register Modify/Display.....	4-28
4.6.15 Stop at Address	4-29
4.6.16 Trace	4-30
4.6.17 Transparent Mode.....	4-31
4.6.18 Verify	4-32
4.6.19 Transfer Data Bootstrap Mode	4-33

CHAPTER 4 OPERATING INSTRUCTIONS

4.7 ASSEMBLY/DISASSEMBLY PROCEDURES	4-35
4.8 DOWNLOADING PROCEDURES.....	4-37
4.8.1 Apple Macintosh (with MacTerminal) to EVBU	4-38
4.8.2 Apple Macintosh (with Red Ryder) to EVBU.....	4-40
4.8.3 IBM-PC (with KERMIT) to EVBU.....	4-41
4.8.4 IBM-PC (with PROCOMM) to EVBU	4-42

CHAPTER 5 HARDWARE DESCRIPTION

5.1 INTRODUCTION	5-1
5.2 GENERAL DESCRIPTION.....	5-1
5.2.1 Microcontroller	5-1
5.2.2 Memory.....	5-3
5.2.3 Real-Time Clock + RAM with Serial Interface.....	5-3
5.2.4 Terminal I/O Port Interface.....	5-3

CHAPTER 6 SUPPORT INFORMATION

6.1 INTRODUCTION	6-1
6.2 CONNECTOR SIGNAL DESCRIPTIONS	6-1
6.3 PARTS LIST.....	6-6
6.4 DIAGRAMS	6-8

APPENDIX A S-RECORD INFORMATION

A-1. INTRODUCTION	1
A-2 S-RECORD CONTENT.....	1
A-3 S-RECORD TYPES	2
A-4 S-RECORD CREATION	3
A-5 S-RECORD EXAMPLE	3

LIST OF FIGURES

2-1. EVBU Connector, Switch, and Jumper Header Location Diagram	2-3
2-2. Wire-Wrap Area (Top Exploded View)	2-18
2-3. Wire-Wrap Area (Side View).....	2-19
2-4. Terminal I/O Port Connector.....	2-22
2-5. Terminal/Host Computer Cable Assembly Diagram.....	2-23
2-6. MCU I/O Port Connector P4 (EVBU Top View)	2-26
2-7. MCU I/O Port Connector P5 (EVBU Bottom View).....	2-27
5-1. EVBU Block Diagram.....	5-2
6-1. EVBU Parts Location Diagram.....	6-8
6-2. EVBU Schematic Diagram (Sheet 1 of 3).....	6-9
6-2. EVBU Schematic Diagram (Sheet 2 of 3).....	6-11
6-2. EVBU Schematic Diagram (Sheet 3 of 3).....	6-13

LIST OF TABLES

1-1. EVBU Specifications	1-2
1-2. External Equipment Requirements.....	1-3
2-1. MCU Mode Select.....	2-7
3-1. Utility Subroutine Jump Table	3-3
3-2. Interrupt Vector Jump Table	3-5
4-1. Monitor Memory Map Limitations	4-2
4-2. Monitor Program Commands.....	4-8
6-1. Input Power Connector (P1) Pin Assignments.....	6-1
6-2. Terminal I/O Port Connector (P2) Pin Assignments.....	6-2
6-3. Battery Backup Connector (P3) Pin Assignments.....	6-3
6-4. MCU I/O Port Connectors (P4 and P5) Pin Assignments.....	6-3
6-5. EVBU Parts List.....	6-6

CHAPTER 1

GENERAL INFORMATION

1.1 INTRODUCTION

This manual provides general information, hardware preparation, installation instructions, monitor program description, operating instructions, hardware description, and support information for the M68HC11 Universal Evaluation Board (hereafter referred to as EVBU).

Downloading S-record information is contained in Appendix A. While a listing of the EVBU monitor program is stored on the diskette supplied with the EVBU (see file buf32.asm). (This file may be viewed using any text reader capable of handling a 102K file.)

1.2 FEATURES

EVBU features include:

- An economical means of debugging user assembled code and evaluating MC68HC11A8, E9, 711E9, 811A8, and 811E2 microcontroller unit (MCU) devices
- One-line assembler/disassembler
- Host computer downloading capability
- MC68HC11 MCU based debugging/evaluating circuitry
- MC68HC68T1 real-time clock + RAM with serial interface peripheral circuitry
- RS-232C compatible terminal I/O port
- Wire-wrap area for custom interfacing
- Single (+5 Vdc) input power source requirements

1.3 SPECIFICATIONS

Table 1-1 lists the EVBU specifications.

Table 1-1. EVBU Specifications

Characteristics	Specifications
MCU	MC68HC11E9FN1
Terminal I/O port	RS-232C compatible
Temperature: Operating Storage	+25 degrees C -40 to +85 degrees C
Relative humidity	0 to 90% (non-condensing)
Power requirements: Primary (P1, Vdd) Secondary (P1, Vdd) (Optional)	+5.0 Vdc @ 50 mA +7.5 to +14.0 Vdc @ 50 mA
Battery backup (P3) (Optional)	+3.0 Vdc @ 25 μ A
Dimensions: Width Length	3.25 in. (8.255 cm) 6.69 in. (16.986 cm)
Wire-wrap Area: Area Holes	Approx. 3in. square (7.62 cm) 29 wide x 30 high (one-tenth inch centers)
Standoffs (Optional)	0.75 in. (1.905 cm) or 1.0 in. (2.54 cm)

1.4 GENERAL DESCRIPTION

The EVBU provides a low cost tool for debugging/evaluation of MC68HC11A8, E9, 711E9, 811A8, and 811E2 MCUs. The MC68HC11 MCU device is an advanced single-chip MCU with on-chip memory and peripheral functions. Refer to the MC68HC11 MCU data sheet for additional device information. The EVBU and a monitor/debugging program called BUFFALO (Bit User Fast Friendly Aid to Logical Operations) demonstrate the capabilities of this MCU. The monitor program is contained in MCU ROM. The debugging/evaluation operation lets you debug user code under control of the BUFFALO monitor program.

There are two ways to assemble user code: use the line assembler in the BUFFALO monitor program or assemble code on a host computer and then download the code to the EVBU user RAM via an Motorola S-records. The monitor program is then used to debug the assembled user code.

Overall debugging/evaluation control of the EVBU is provided by the monitor program via terminal interaction. RS-232C terminal I/O port interface circuitry provides communication and data transfer operations between the EVBU and external terminal/host computer devices. The terminal I/O port is fixed at 9600 baud.

The EVBU has a wire-wrap area for MCU custom interfacing. The wire-wrap hole pattern lets you install most standard dual-in-line package (DIP) device wire-wrap sockets, strip sockets, headers, and connectors. Wire-wrap components can be installed on the topside of the EVBU printed circuit board (PCB), and wire wrapping can be performed on the bottom side of the PCB. MCU interfacing is accomplished via the MCU I/O port connector to the wire-wrap area.

EVBU operation requires a user-supplied +5 Vdc power supply and an RS-232C compatible terminal. You must use an RS-232C compatible host computer to download Motorola S-records via EVBU terminal I/O port. Download the BUFFALO monitor commands.

The Motorola S-record format was devised for the purpose of encoding programs or data files in a printable format for transportation between computer systems. Refer to Appendix A for additional S-record information.

1.5 EQUIPMENT REQUIRED

Table 1-2 lists the external equipment requirements for EVBU operation.

Table 1-2. External Equipment Requirements

External Equipment
+5 Vdc power supply ⁽¹⁾
Terminal (RS-232C compatible)
Host computer (RS-232C compatible) ⁽²⁾
Terminal/host computer – EVBU RS-232C cable assembly ⁽¹⁾
1. Refer to Chapter 2 for details. 2. Optional – not required for basic operation.

1.6 CUSTOMER SUPPORT

For information about a Motorola distributor or sales office near you call:

AUSTRALIA, Melbourne – (61-3)887-0711 Sydney – 61(2)906-3855	JAPAN, Fukuoka – 81-92-725-7583 Gotanda – 81-3-5487-8311 Nagoya – 81-52-232-3500 Osaka – 81-6-305-1802 Sendai – 81-22-268-4333 Takamatsu – 81-878-37-9972 Tokyo – 81-3-3440-3311
BRAZIL, Sao Paulo – 55(11)815-4200	KOREA, Pusan – 82(51)4635-035 Seoul – 82(2)554-5118
CANADA, B. C., Vancouver – (604)606-8502 ONTARIO, Toronto – (416)497-8181 ONTARIO, Ottawa – (613)226-3491 QUEBEC, Montreal – (514)333-3300	MALAYSIA, Penang – 60(4)2282514
CHINA, Beijing – 86-10-68437222	MEXICO, Mexico City – 52(5)282-0230 Guadalajara – 52(36)21-8977
DENMARK – (45)43488393	PUERTO RICO, San Juan – (809)282-2300
FINLAND, Helsinki – 358-9-6824-400	SINGAPORE – (65)4818188
FRANCE, Paris – 33134 635900	SPAIN, Madrid – 34(1)457-8204
GERMANY, Langenhagen/Hannover – 49(511)786880 Munich – 49 89 92103-0 Nuremberg – 49 911 96-3190 Sindelfingen – 49 7031 79 710 Wiesbaden – 49 611 973050	SWEDEN, Solna – 46(8)734-8800
HONG KONG, Kwai Fong – 852-6106888 Tai Po – 852-6668333	SWITZERLAND, Geneva – 41(22)799 11 11 Zurich – 41(1)730-4074
INDIA, Bangalore – (91-80)5598615	TAIWAN, Taipei – 886(2)717-7089
ISRAEL, Herzlia – 972-9-590222	THAILAND, Bangkok – 66(2)254-4910
ITALY, Milan – 39(2)82201	UNITED KINGDOM, Aylesbury – 441(296)395-252 UNITED STATES, Phoenix, AZ – 1-800-441-2447

For a list of the Motorola sales offices and distributors: http://www.mcu.motsp.com/sale_off.html

CHAPTER 2

HARDWARE PREPARATION AND INSTALLATION

2.1 INTRODUCTION

This chapter provides unpacking instructions, hardware preparation, and installation instructions for the EVBU.

2.2 UNPACKING INSTRUCTIONS

NOTE

If upon receipt the shipping carton is damaged, request carrier's agent is present during unpacking and inspection of the EVBU.

Unpack EVBU from shipping carton. Refer to packing list and verify that all items are present. Save packing material for storing or reshipping the EVBU.

2.3 HARDWARE PREPARATION

This paragraph describes the inspection/preparation of EVBU components prior to use. This description ensures the EVBU components are properly configured before start up.

The EVBU should be inspected and prepared for proper jumper placements. Figure 2-1 illustrates the EVBU connector, switch, and jumper header locations. Diode jumpers (DJX) and test point (TPX) locations are also illustrated.

An external +5 Vdc power supply connects to P1 on the EVBU. External terminal/host computer equipment connects to P2 on the EVBU. An external battery may be connected to P3 on the EVBU for battery backup purposes. Connectors P4 and P5 are used to connect the EVBU to the wire-wrap area or other user-supplied equipment.

Switch S1 lets you reset the EVBU.

NOTES

The following pages describe the EVBU jumper headers. Jumper headers consist of feed-thru holes, feed-thru holes with cut-trace shorts on the printed circuit board (PCB) solder side, and jumper headers with fabricated jumpers installed as shown in Figure 2-1.

The EVBU (factory configuration) is shown in Figure 2-1. The EVBU is configured for MC68HC11E9 MCU single-chip mode of operation.

CAUTION

Depending on the application, you may need to cut the cut-trace shorts on the PCB solder side. Use extreme care when cutting the cut-trace shorts to avoid cutting adjacent PCB wiring traces. Failure to adhere to this *CAUTION* could result in many hours of troubleshooting and repair time.

Jumper header locations J1 through J15 provide the following functional capabilities:

- Input Power Select (J1)
- Program Execution Select (J2)
- MCU Mode Select (J3 and J4)
- MCU Clock Reconfiguration (J5 and J6)
- Trace Enable (J7)
- SCI Reconfiguration (J8 and J9)
- SPI Reconfiguration (J10 thru J12)
- Real-Time Clock INT* (J14)
- TxD Reconfiguration (J15)

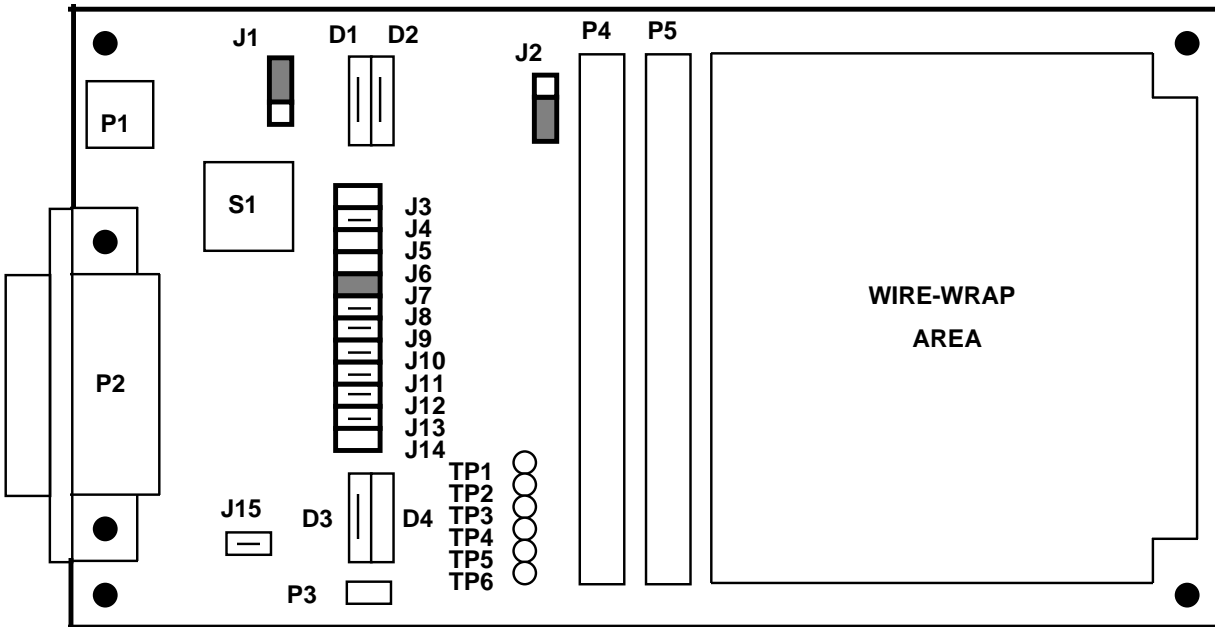





-  DENOTES FABRICATED JUMPER INSTALLED ON JUMPER HEADER.
-  DENOTES JUMPER HEADER SUPPLIED.
-  DENOTES CUT-TRACE SHORT ON PCB SOLDER SIDE.
-  DENOTES FEED-THRU HOLES ONLY.
-  DENOTES FEED-THRU HOLES ONLY.

Figure 2-1. EVBU Connector, Switch, and Jumper Header Location Diagram

2.3.1 Input Power Select Header (J1)

Use jumper header J1 to select the input power to be applied to the EVBU. The EVBU is factory-configured and shipped with a fabricated jumper installed on pins 1 and 2 as shown below. In this configuration, you must supply +5.0 Vdc @ 50 mA to the input power connector P1.

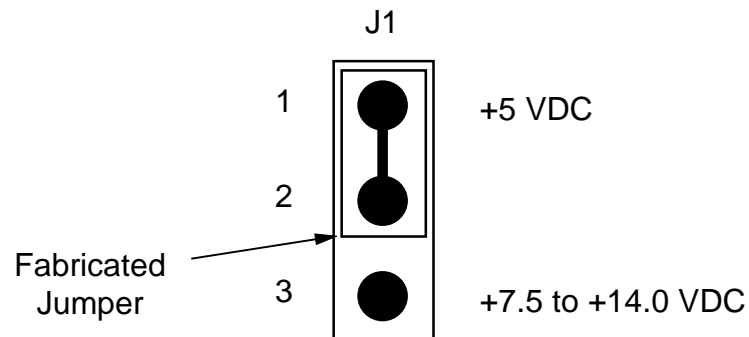

If a +5 Vdc power supply is not available, you can connect an alternate power source (+7.5 to +14.0 Vdc) to the input power connector P1. To utilize this secondary power source, install an MC78L05C voltage regulator at location U1 (shown below). After installing the voltage regulator, move the fabricated jumper on pins 1 and 2 of jumper header J1 to pins 2 and 3.

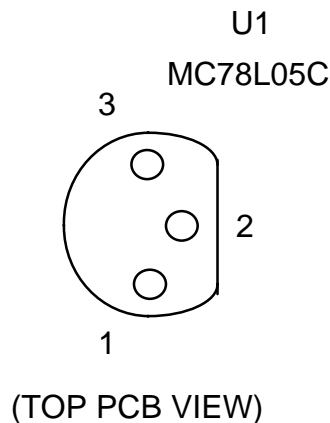

2.3.2 Program Execution Select Header (J2)

Use jumper header J2 to select whether the BUFFALO monitor prompt is displayed or if a jump to internal EEPROM is executed. At reset the monitor checks the logic state of the PE0 line. If $PE0 = 0$ (a jumper installed on pins 2 and 3 of jumper header J2) the monitor program is executed and the prompt displayed. If $PE0 = 1$ (a jumper is installed on pins 1 and 2 of jumper header J2) the monitor automatically jumps directly to EEPROM (address location \$B600) and executes user program code without monitor intervention.

The EVBU is factory-configured and shipped with a jumper installed on pins 2 and 3 of jumper header J2 (BUFFALO monitor program execution, shown below). Reconfigure the EVBU by moving the jumper to pins 1 and 2 of jumper header J2 if you want to jump directly to EEPROM address \$B600 for user code execution.

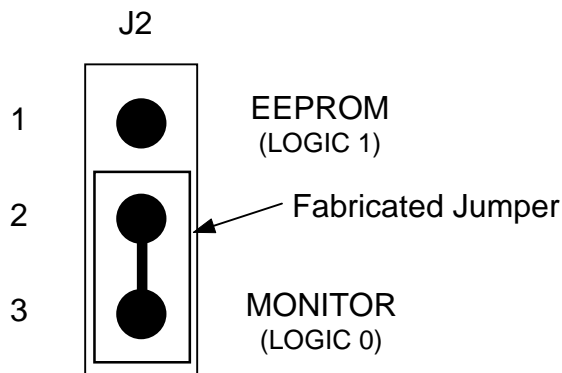

If you use the PE0 line for A/D operations, the loading condition introduced by jumper header J2 may not be desired. There are two ways to bypass this potential problem.

1. Jumper header J2 is only required at the trailing edge of reset, so you can remove the fabricated jumper after reset. Using this method, it is possible that your target system circuitry might drive the PE0 line to the wrong state during reset.
2. Program the first three EEPROM locations with \$7E, \$E0, and \$0A, respectively. Next, remove installed jumper from jumper header J2. Independent of the level present on the PE0 line, the BUFFALO monitor will gain control after a reset operation.

For additional EEPROM jump operation information, described above, refer to EVBU monitor program (lines 0162 and 0163) of the listing stored on the EVBU diskette (see file buf32.asm).

2.3.3 MCU Mode Select Headers (J3 and J4)

Use jumper headers J3 and J4 to select the MCU operation mode. The EVBU resident M68HC11E9 MCU device (U3) is factory configured and shipped for single-chip mode of operation. No fabricated jumpers are required on jumper headers J3 and J4 for this configuration due to the cut-trace short on PCB solder side of J4.

If the J4 cut trace short is cut, you must install a user-supplied fabricated jumper on jumper header J4 to return the EVBU to the factory configuration (single-chip mode). Jumper header J3 does not contain a cut trace short.

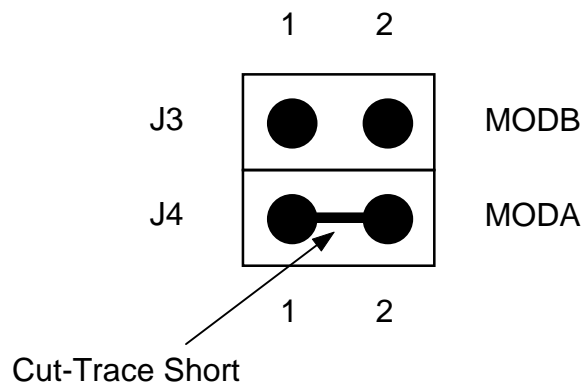

NOTE

If J4 cut-trace short is cut, you must install a user-supplied fabricated jumper on J4 to return it to the factory configuration.

In order to select the expanded-multiplexed, special-bootstrap, or special-test modes of operation, remove the cut-trace short between pins 1 and 2 of jumper header J4,. Then install user-supplied fabricated jumpers on jumper headers J3 and J4. Refer to Table 2-1 for directions when configuring the desired EVBU M68HC11E9 MCU mode of operation.

Table 2-1. MCU Mode Select

J4 – MODA (1)	J3 – MODB	MCU Mode Select
Installed (2)	Removed	Single-Chip
Removed (3)	Removed	Expanded-Multiplexed
Installed (2)	Installed	Special-Bootstrap
Removed (3)	Installed	Special-Test
NOTES		
1. Installed jumper equals a logic 0 (shorted to ground), while a missing jumper equals a logic 1 (open/pull-up).		
2. The cut-trace short is present or a jumper is installed on J4.		
3. The cut-trace short and jumper are removed from J4.		

The EVBU can be reconfigured for either the single-chip, expanded-multiplexed, special-bootstrap, or special-test modes of operation via jumper headers J3 and J4. For expanded-multiplexed and special-test modes of operation, additional peripheral circuitry must be implemented on the EVBU wire-wrap area to support the expanded modes. The EVBU can be reconfigured for the special-bootstrap mode of operation without additional peripheral circuitry.

2.3.4 MCU Clock Reconfiguration Headers (J5 and J6)

Use jumper headers J5 and J6 to connect the MCU EXTAL and XTAL signals (pins 7 and 8) to the MCU I/O port connectors P4 and P5. This configuration is for remote applications. The EVBU is factory configured and shipped without installed fabricated jumpers (shown below).

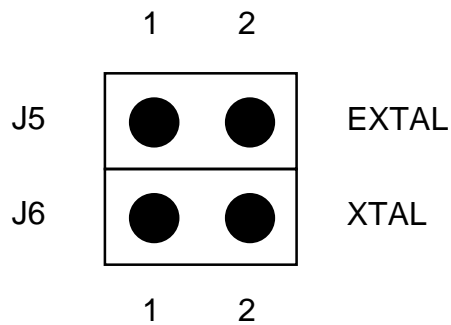

NOTE

Care should be taken when routing the EXTAL and XTAL signals to a target system environment and/or EVBU wire-wrap area. Additional capacitance and/or extra noise could render the resident MCU oscillator non functional.

For special applications using the MCU EXTAL and XTAL signals in a target system environment or EVBU wire-wrap area, install fabricated jumpers on jumper headers J5 and J6. When jumpers are installed, both EXTAL and XTAL signals are routed to the MCU I/O port connectors P4 and P5.

2.3.5 Trace Enable Header (J7)

Use jumper header J7 to select BUFFALO monitor debug operations by connecting the PA3/OC5 signal (pin 2) to the XIRQ* signal (pin 1). The EVBU is factory-configured and shipped with a fabricated jumper installed on pins 1 and 2 as shown below. This jumper must be installed during debugging operations.

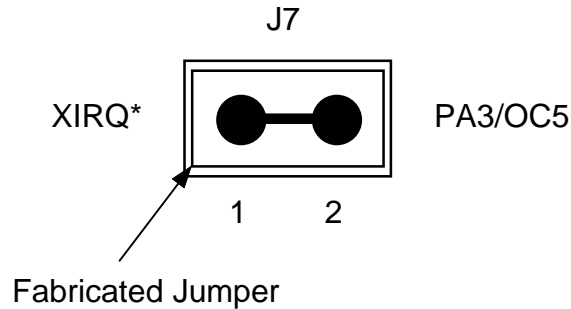

For special applications which use the PA3/OC5 signal, remove the fabricated jumper on pins 1 and 2 to avoid interference between the PA3/OC5 signal and the XIRQ* signal. In this configuration, several BUFFALO monitor commands are not available. BUFFALO commands which will not function without a jumper installed on J7 are: proceed (P), stop at address (STOPAT), and trace (T) commands.

Refer to the schematic diagram (Figure 6-2) located in Chapter 6 for PA3/OC5 signal wiring information.

2.3.6 SCI Reconfiguration Headers (J8 and J9)

Use jumper headers J8 and J9 (shown below) to connect the MCU PD0/RXD and PD1/TXD serial communications interface (SCI) signal lines to the MC145407 RS-232C driver/receiver device (located at U4). Jumper headers J8 and J9 have feed-thru holes with cut-trace shorts. Fabricated jumpers for jumper headers J8 and J9 are not supplied by the factory.

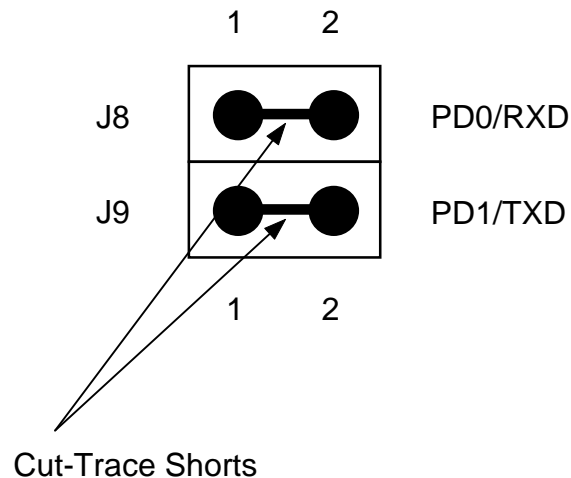

NOTE

If J8 and J9 cut-trace shorts are cut, you must install user-supplied fabricated jumpers on J8 and J9 to return them to the factory configuration.

When isolation of the PD0/RXD and PD1/TXD signal lines (from the MCU SCI to the MC145407 RS-232C driver/receiver device) are required, you must cut the cut-trace shorts. To return jumper headers J8 and J9 to the factory configuration install user supplied fabricated jumpers on the J8 and J9. Refer to the schematic diagram (Figure 6-2) located in Chapter 6 for PD0/RXD and PD1/TXD signal wiring information.

2.3.7 SPI Reconfiguration Headers (J10 thru J13)

Use jumper headers J10 through J13 (shown below) to connect the MCU PD4/SCK, PD2/MISO, PD3/MOSI, and PD5/SS serial peripheral interface (SPI) signal lines to the MC68HC68T1 peripheral device (location U5). The feed-thru holes for jumper headers J10 through J13 have cut-trace shorts. Fabricated jumpers for jumper headers J10 through J13 are not supplied by the factory.

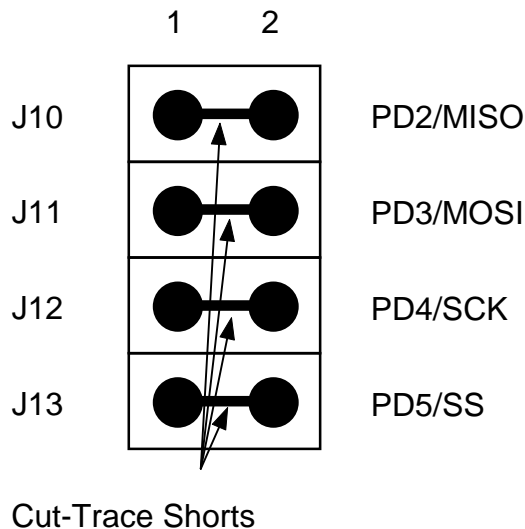

NOTE

If J10 through J13 cut-trace shorts are removed, you must install user-supplied fabricated jumpers on J10 through J13 to return them to the factory configuration.

When isolation of the PD4/SCK, PD2/MISO, PD3/MOSI, and PD5/SS signal lines (from the MCU SPI to the MC68HC68T1 peripheral device) are required, cut the solder-side traces. To return J10 through J13 to the factory configuration install user supplied fabricated jumpers on jumper headers J10 through J13. Refer to the schematic diagram (Figure 6-2) located in Chapter 6 for PD4/SCK, PD2/MISO, PD3/MOSI, and PD5/SS signal wiring information.

2.3.8 Real-Time Clock INT* Header (J14)

Use jumper header J14 (shown below) to disconnect the MCU XIRQ* signal line from the MC68HC68T1 peripheral device (located at U5) INT* signal pin. The EVBU is factory configured and shipped without a fabricated jumper installed on pins 1 and 2 as shown below. Jumper header J14 is used to connect the INT* output of the MC68HC68T1 peripheral device to the MCU XIRQ* signal line.

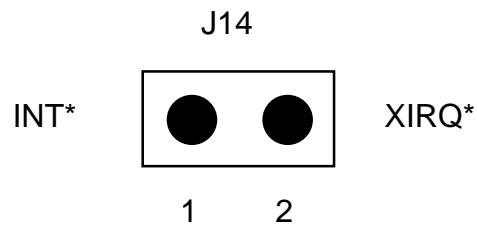

NOTE

The INT* signal line is a output signal which is connected to the XIRQ* input of the MCU. XIRQ* is also used by the BUFFALO monitor for tracing (refer to paragraph 2.3.5). Refer to the jumper header J7 and jumper header J14 descriptions because the respective functions could interfere with each other.

When connection of the MC68HC68T1 peripheral device INT* signal line to the MCU is required, you must install a (user supplied) fabricated jumper on the component side of the PCB. Refer to the schematic diagram (Figure 6-2) located in Chapter 6 for INT* and XIRQ* signal wiring information.

2.3.9 TxD Reconfiguration Header (J15)

As shipped, jumper header J15 (shown below) is used to connect the MC145407 RS-232C driver/receiver device (located at U4) TxD signal line to the terminal port connector P2. No jumper header is installed in location J15, it consists of two feed-thru holes with a cut-trace short.

When the cut trace is cut, a user connection is made to J15 pin 2 to facilitate driving a buffered TxD signal to a user system in the special-bootstrap mode (with the XBOOT command) without the removal of the external terminal connected to the EVBU terminal port connector P2.

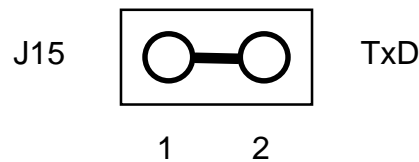

NOTE

If J15 cut-trace short is cut, you may solder a grounding strap between the feed-through-holes on J15 to return it to the factory configuration.

When the TxD signal line is required for an external connection, you must cut the solder-side trace and make the connection to J15 pin 2. When reconfiguration of the TxD signal line is required, you must solder a user-supplied jumper header in the J15 feed-through-holes and then install a fabricated jumper on the jumper header. Refer to the parts list contained in Chapter 6 for jumper header J15 component description. Refer to the schematic diagram (Figure 6-2) located in Chapter 6 for TxD signal wiring information.

2.4 REAL-TIME CLOCK, RAM, SERIAL INTERFACE PERIPHERAL

A user-supplied HCMOS real-time clock, RAM, and serial interface peripheral device (MC68HC68T1) can be installed on the EVBU at location U5. The MC68HC68T1 peripheral device contains a real-time clock/calendar, a 32 x 8 static RAM, and a synchronous, serial, three wire interface for MCU communications. Operating in a burst mode, successive clock or RAM locations can be read or written using only a single starting address. An on-chip oscillator allows acceptance of a selectable crystal frequency or the device can be programmed to accept a 50/60 Hz line input frequency.

Features of the MC68HC68T1 peripheral device are as follows:

- Full clock features – seconds, minutes, hours (AM/PM), day-of-week, date, month, year (0-99), auto leap year
- 32 word by 8-bit RAM
- Direct interface to Motorola serial peripheral interface (SPI)
- Minimum time-keeping voltage 2.2 V
- Burst mode for reading/writing successive addresses in clock or RAM
- Selectable crystal or 50/60 Hz line input
- Binary-coded-decimal (BCD) data contained in registers
- Buffered clock output for driving CPU clock, timer, colon, or liquid crystal display (LCD) backplane
- Power-on reset with first-time-up flag
- Freeze circuit eliminates software overhead during a clock read
- Three independent interrupt modes – alarm, periodic, or power-down sense
- CPU reset output – provides orderly power up/down
- Watchdog circuit

Refer to the MC68HC68T1 Real-Time Clock plus RAM with Serial Interface data sheet (MC68HC68T1/D) for additional device information.

In addition to the MC68HC68T1 circuitry, diode jumpers (D1-D4) and test points (TP1-TP6) are also included. The following paragraphs describes the purposes of the diode jumpers and test points in conjunction with the MC68HC68T1 device installed in socket location U5.

2.4.1 Diode Jumpers (D1-D4)

Diode jumpers D1-D4 (shown below) are provided on the EVBU for the real-time clock battery backup operations. The diode jumpers (D1), (D2), and (D3) consist of feed-thru holes with cut traces on the PCB solder side. Diode jumper D4 feed-thru holes do not include a cut trace.

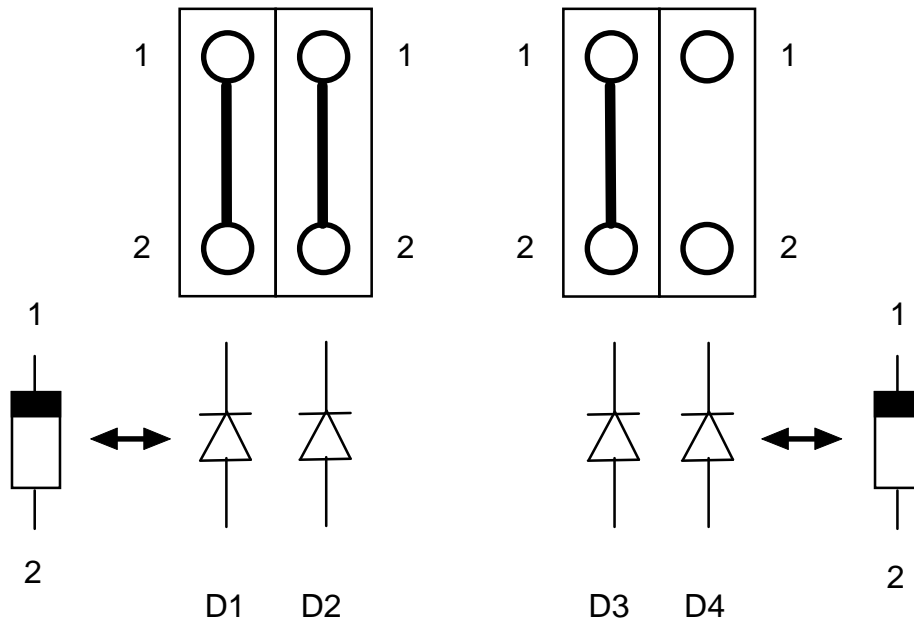

If the MC68HC68T1 real-time clock battery backup feature is required, you must cut the D1-D3 feed-thru hole cut traces on the PCB solder side, and install the following user-supplied components on the PCB component side as follows:

- D1 1N4001 diode
- D2 1N4148 diode
- D3 1N4148 diode
- D4 1N4148 diode, jumper wire, or resistor (application dependent)

A user-supplied +3.0 Vdc @ 25 μ A battery is connected to the EVBU battery connector P3 (feed-thru holes designated + and -) for battery backup purposes as shown below.

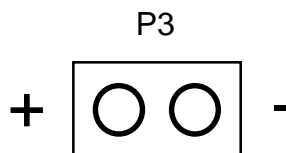

The type of battery selected for connector P3 will affect the choice of the component (diode, jumper wire, or resistor) that will be installed in location D4. Refer to the MC68HC68T1 data sheet and battery manufacturer recommendations for additional details. Refer to the parts list contained in Chapter 6 for the battery connector P3 and diode jumpers D1-D4 component descriptions.

2.4.2 Test Points (TP1-TP6)

Test points TP1-TP6 (shown below) are provided for the user-supplied MC68HC68T1 device installed in socket location U5. These test point consists of six feed-thru holes. If desired, you can install a single pin header post (Aptronics # 929705-01-01) in each feed-thru hole.

- TP1 CLK OUT = Clock Output
- TP2 CPUR* = CPU Reset
- TP3 VSYS = System Voltage
- TP4 LINE = Line Sense
- TP5 POR* = Power-On Reset
- TP6 PSE = Power Supply Enable

The above test points are provided for user monitoring and wire-wrap area application purposes for the MC68HC68T1 device. Refer to the MC68HC68T1 Real-Time Clock plus RAM with Serial Interface data sheet (*MC68HC68T1/D*) for additional device information pertaining to the above test point signals. Refer to the parts list contained in Chapter 6 for test points TP1-TP6 component descriptions.

2.5 WIRE-WRAP AREA

The EVBU provides a small wire-wrap area for MCU custom interfacing. The wire-wrap area is approximately 3.0 inches square, consisting of 29 holes wide by 30 holes high. The holes are on one-tenth inch centers. Figure 2-2 illustrates an exploded view of the wire-wrap area. A ground (GND) bus strip resides on the outside parameter of the wire-wrap area. A +5 Vdc bus is also provided at the upper left end of the wire-wrap area.

With the wire-wrap hole pattern provided, dual-in-line package (DIP) device wire-wrap sockets, strip sockets, headers, and connectors can be installed. Wire-wrap components can be installed on the top side of the EVBU, and wire wrapping can be performed on the bottom side of the EVBU. The use of three-quarter or one inch standoffs are recommended for wire-wrap pin clearance on the bottom side of the EVBU. The standoff mounting holes are shown below.

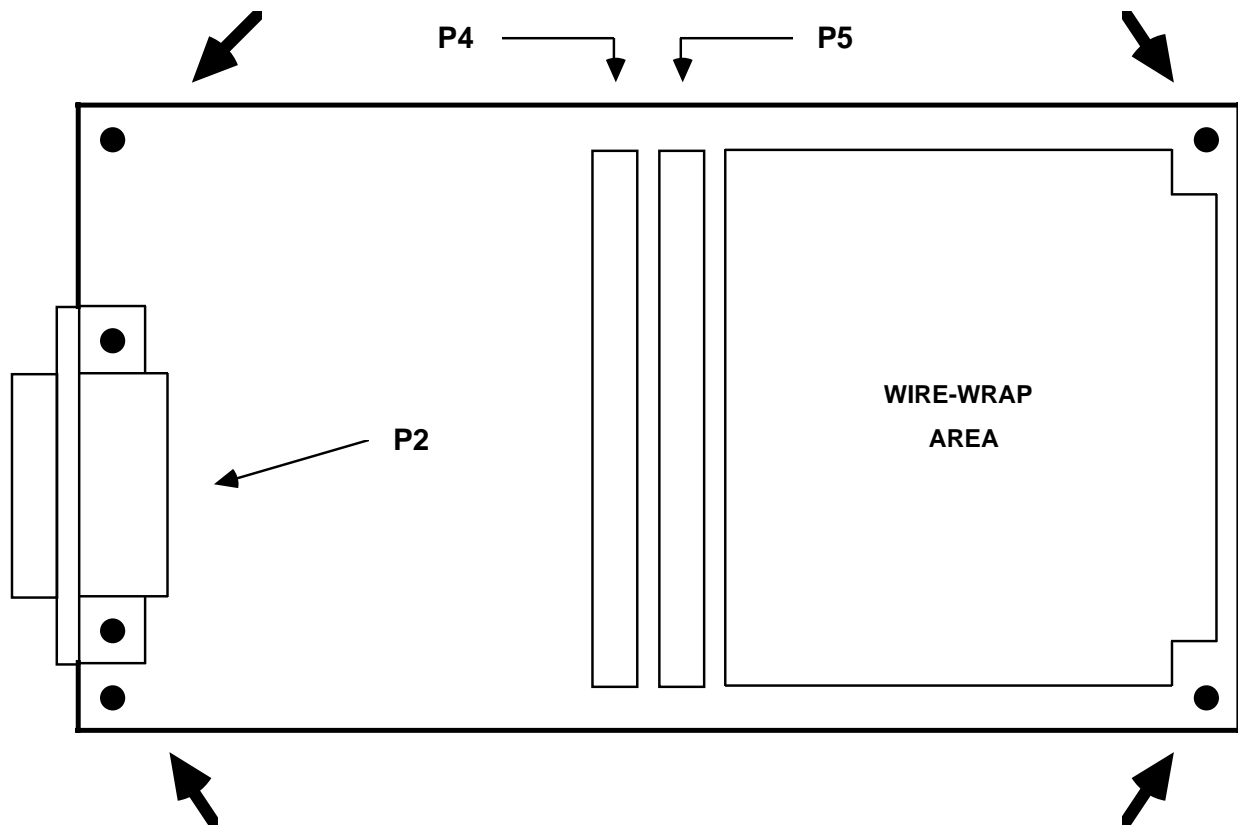

Two 60-pin MCU I/O port connectors P4 and P5 are provided on the EVBU. Connector P4 is factory supplied and connector P5 is user supplied. Refer to the parts list contained in Chapter 6 for connector P5 component description. As shown on the following page, connector P5 supplies the EVBU wire-wrap area with the +5 Vdc and ground (GND) power connections.

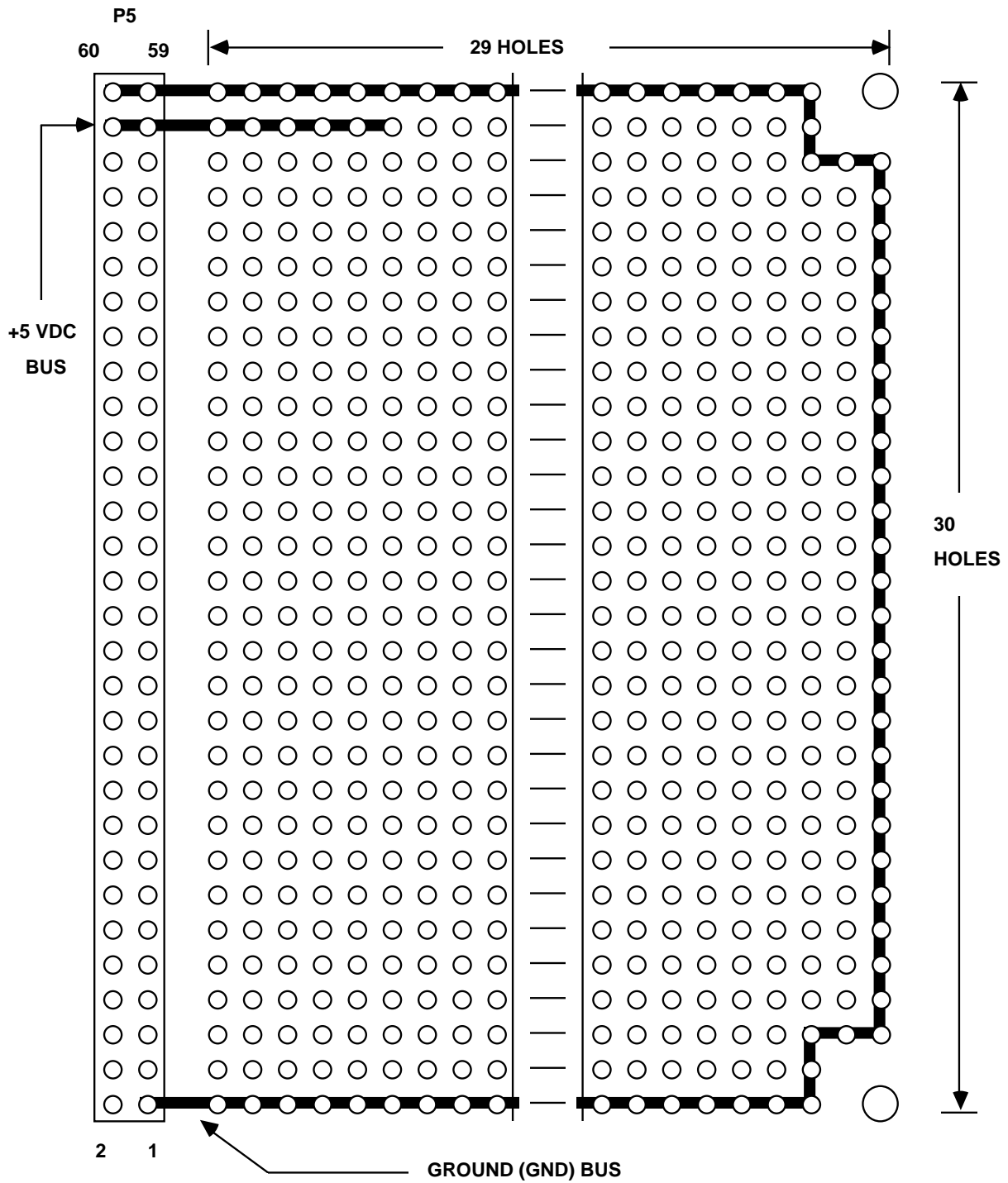

Figure 2-2. Wire-Wrap Area (Top Exploded View)

Use connectors P4 and P5 to interface to the resident MC68HC11E9 MCU device (at location U3). A user-supplied wire-wrap type header (connector) is installed at location P5 on the solder side of the PCB (shown in Figure 2-3). Both P4 and P5 connectors are wired parallel to each other. Connector P4 is primarily used to interface to external equipment or target system. Connector P5 is primarily used to interface directly to the EVBU wire-wrap area.

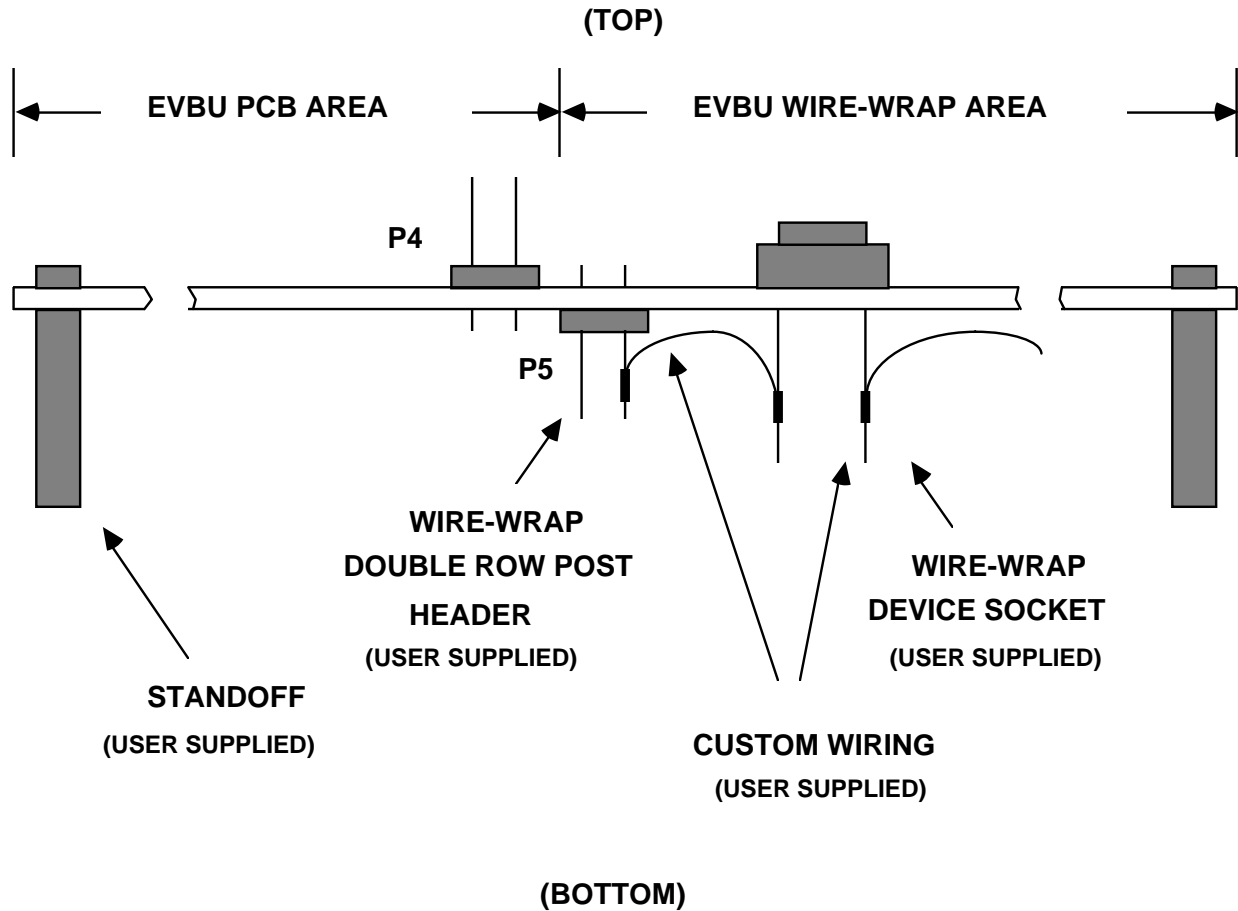

Figure 2-3. Wire-Wrap Area (Side View)

2.6 INSTALLATION INSTRUCTIONS

The EVBU is designed for table top operation. A user-supplied +5 Vdc power supply and RS-232C compatible terminal are required for EVBU operation. An RS-232C compatible host computer is optional for downloading user assembled code to the EVBU via the terminal I/O port connector P2.

2.6.1 Power Supply – EVBU Interconnection

The EVBU requires +5 Vdc @ 50 mA and GND for operation. Interconnection of the power supply wiring to the EVBU power supply connector P1 is shown below.

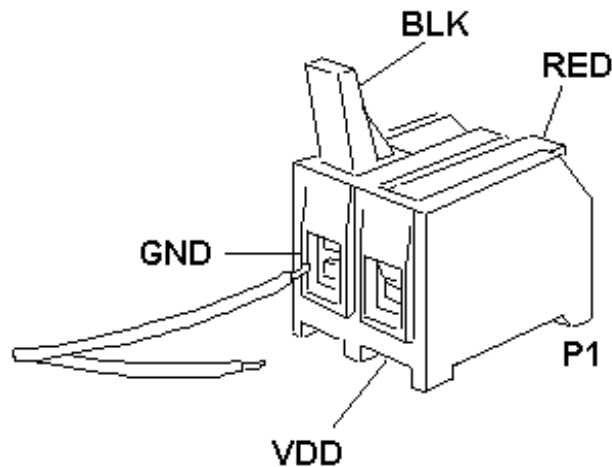

The power supply cable consists of two 14-22 AWG wires that interconnect +5 Vdc and ground (GND) from the user-supplied power supply to the EVBU connector P1.

Jumper header J1 is used to select the input power to be applied to the EVBU. The EVBU is factory-configured and shipped with the fabricated jumper installed on pins 1 and 2 as shown below. In this configuration, you must supply +5.0 Vdc @ 50 mA (max) to the input power connector P1.

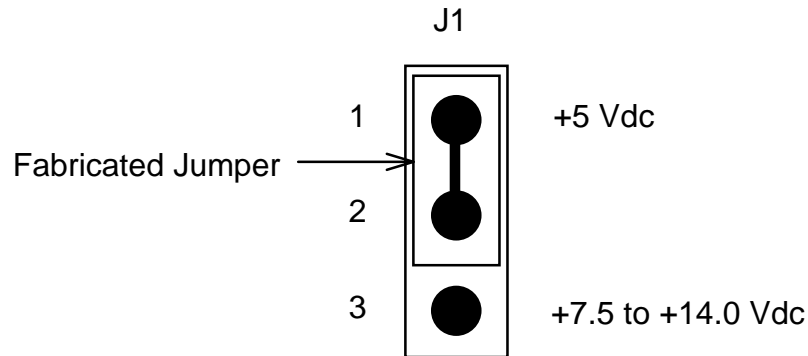

If a +5 Vdc power supply is not available, an alternate power source (+7.5 to +14.0 Vdc) can be connected to the input power connector P1. To utilize this secondary power source, install an MC78L05C voltage regulator at location U1. Upon completion of the voltage regulator installation, you must reinstall the fabricated jumper on jumper header J1, from pins 1 and 2 to pins 2 and 3.

2.6.2 Terminal – EVBU Interconnection

Interconnection of an RS-232C compatible terminal to the EVBU is accomplished via a user-supplied cable assembly as shown in Figure 2-5. Connect one end of the cable assembly to EVBU connector P2 (shown in Figure 2-4). Connect the other end of the cable assembly to the user-supplied terminal/host computer. Refer to Chapter 6 for connector pin assignments and signal descriptions of EVBU terminal port connector P2.

For those using an IBM-PC or Apple Macintosh personal computer (PC), use a Hayes-compatible-modem cable to connect the PC to EVBU terminal port connector P2.

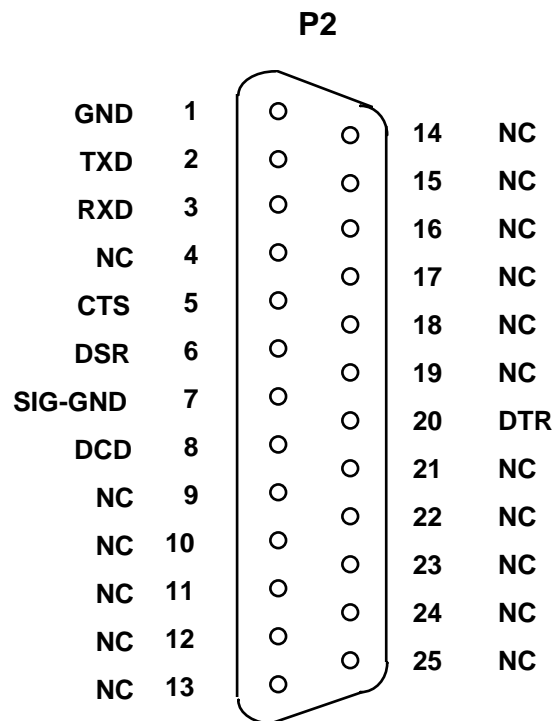

Figure 2-4. Terminal I/O Port Connector

Figure 2-5 illustrates a suitable cable assembly for connecting the EVBU to a dumb terminal. This cable assembly is made from standard mass termination ribbon cable components.

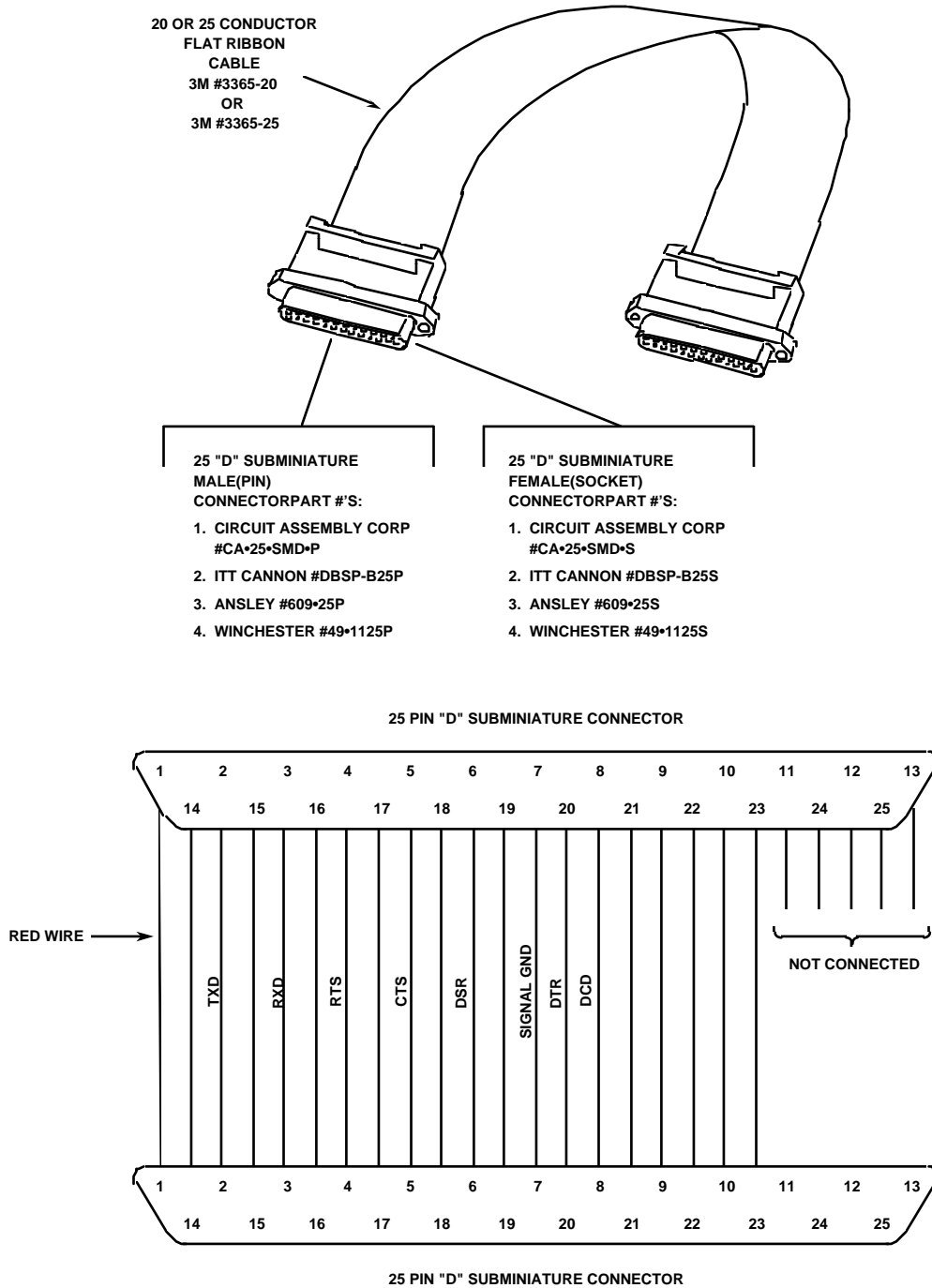

Figure 2-5. Terminal/Host Computer Cable Assembly Diagram

A Hayes compatible modem cable, purchased from your local computer store, can be used to connect the EVBU to your host computer.

The EVBU is wired as data communication equipment (DCE) whereas a dumb terminal and most serial modem ports on host computers are wired as data terminal equipment (DTE). This should allow a straight-through cable to be used in most setups.

If an unknown cable is used to connect the EVBU to a host computer, a null modem adapter (shown below) may be required to match the cable to the EVBU terminal port connector.

A null modem adapter is used to reverse the roles of various data and control signals to make a DTE device appear as a DCE device or vice versa.

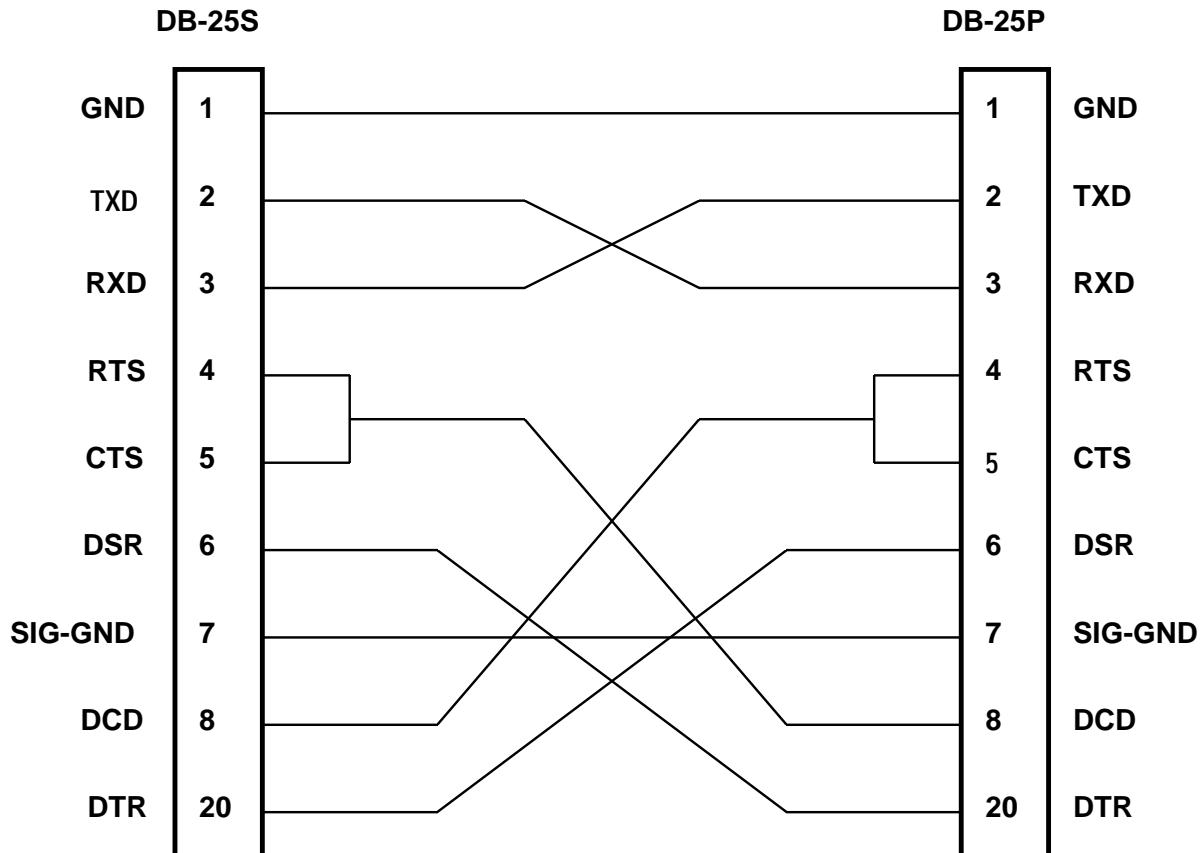

NULL MODEM ADAPTER

2.6.3 External Equipment – MCU Interconnection

External equipment to MCU interconnection is accomplished via the EVBU MCU I/O port connector P4. *Connector P4 is supplied by the factory.* This connector is mounted on the top side of the EVBU PCB (shown in Figure 2-3). Connector P4 (shown in Figure 2-6) is a 60-pin header that facilitates the interconnection of the EVBU MCU circuitry to external equipment or target system equipment.

For connector pin assignments and signal descriptions of the EVBU MCU I/O port connector P4, refer to Chapter 6.

2.6.4 Wire-Wrap Area – MCU Interconnection

Wire-wrap area to MCU interconnection is accomplished via the EVBU MCU I/O port connector P5. Connector P5 is supplied by the user. This connector is mounted on the bottom side of the EVBU PCB (shown in Figure 2-6). Connector P5 (shown in Figure 2-7) is a 60-pin header that facilitates the interconnection of the EVBU MCU circuitry to the EVBU wire-wrap area components.

For connector pin assignments and signal descriptions of the EVBU MCU I/O port connector P5, refer to Chapter 6. Refer to the parts list contained in Chapter 6 for the connector P5 component description.

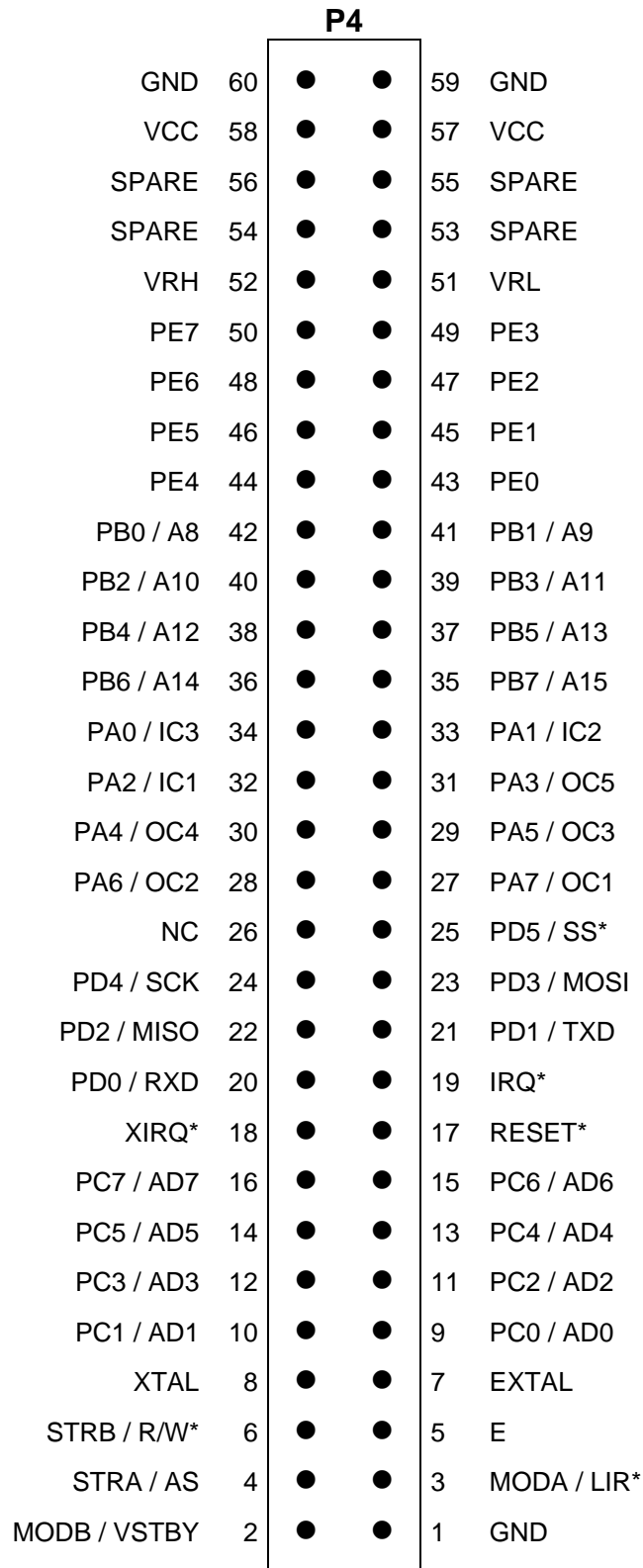

Figure 2-6. MCU I/O Port Connector P4 (EVBU Top View)

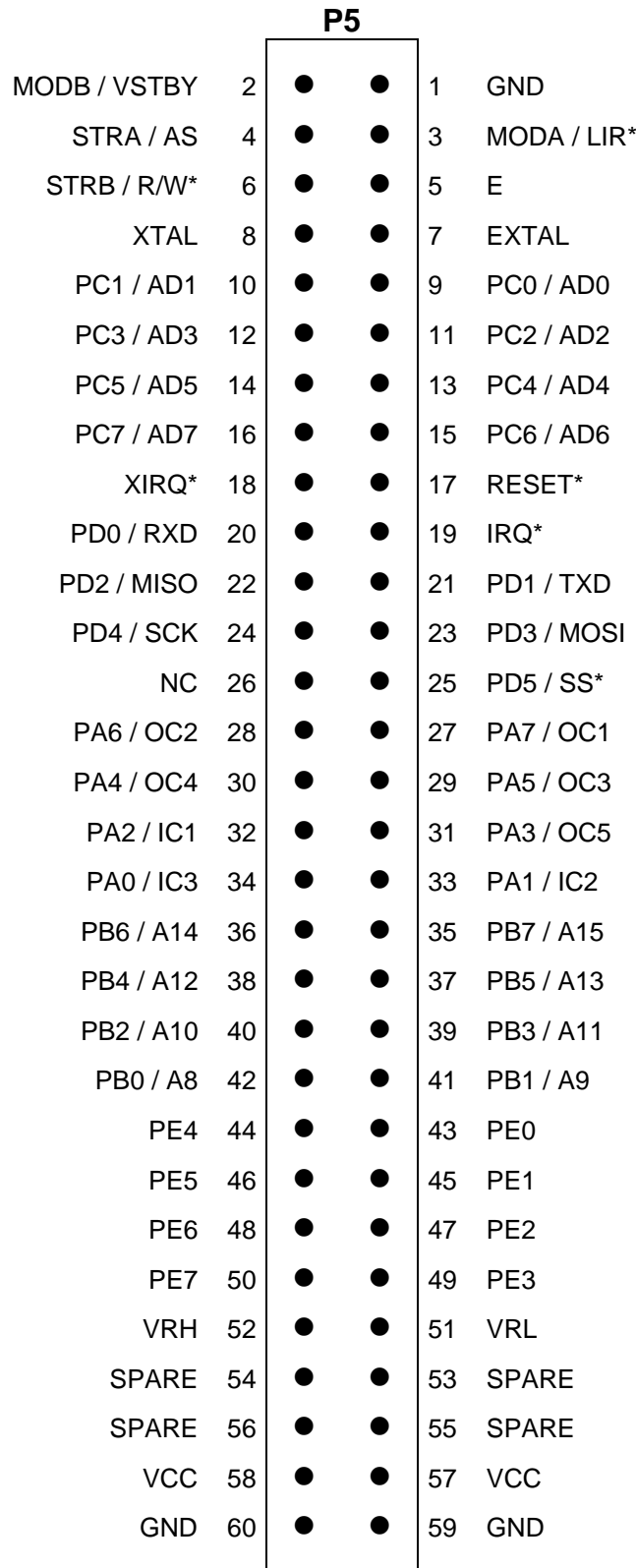
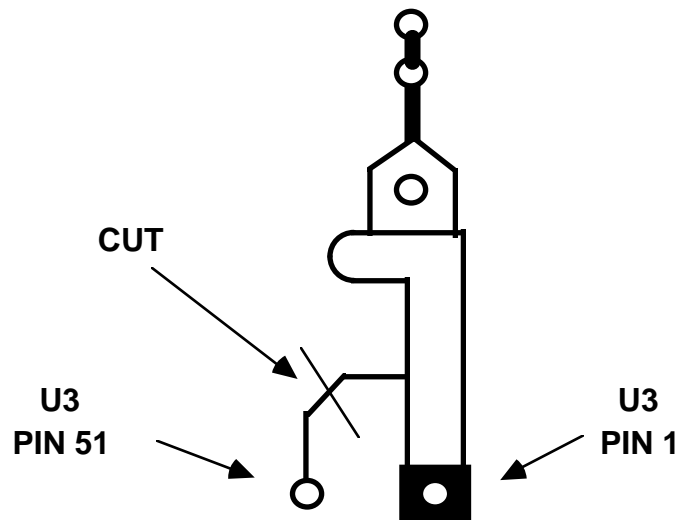

Figure 2-7. MCU I/O Port Connector P5 (EVBU Bottom View)

2.6.5 MCU A/D Converter Circuitry Modifications

The EVBU PCB contains a default cut trace located on the solder side of the PCB. This cut trace is used to isolate the resident MCU device VRL pin (pin 51) from ground (pin 1) when an external VRL signal source is used (refer to the schematic diagram Figure 6-2 for additional information). The PCB default cut trace is illustrated below.



PCB SOLDER SIDE

Consult the MC68HC11E9 data sheet for specific information pertaining to the use of the VRL pin.

CHAPTER 3

MONITOR PROGRAM

3.1 INTRODUCTION

This chapter is a description of the monitor program. This description enables you to understand the basic structure of the program.

3.2 PROGRAM DESCRIPTION

The BUFFALO (bit user fast friendly aid to logical operations) monitor program is supplied with the EVBU. The EVBU monitor program is stored in the MCU internal ROM and communicates via the MCU serial communications interface (SCI). Refer to the buf32.asm file on the EVBU diskettes for additional information pertaining to the monitor (BUFFALO) program.

The BUFFALO monitor program consists of five parts (or sections) as follows:

1. Initialization
2. Command interpreter
3. I/O routines
4. Utility subroutines
5. Command table

3.2.1 Initialization

This part of BUFFALO contains all of the reset initialization code. In this section, internal RAM locations are set up, and the I/O channel for the terminal is set up. To set up the terminal I/O port, BUFFALO must determine if the terminal is connected to the SCI (as in the EVBU) or to an external ACIA or DUART. This is accomplished by sending a sign-on message to all ports and then waiting for you to type carriage return <CR> on whichever device is the terminal port. When BUFFALO recognizes a carriage return from a port, that port is then used for all subsequent terminal I/O operations. The EVBU terminal device is normally connected to the SCI.

3.2.2 Command Interpreter

The next section of BUFFALO is the command interpreter. American Standard Code for Information Interchange (ASCII) characters are read from the terminal into the input buffer until a carriage return or a slash (/) is received. The command field is then parsed out of the input buffer and placed into the command buffer. A table of commands is then searched and if a match is found, the corresponding command module is called as a subroutine. All commands return control back to the command interpreter upon completion of the operation.

3.2.3 I/O Routines

The I/O section of BUFFALO consists of a set of supervisor routines, and three sets of driver routines. The supervisor routines are INIT, INPUT, and OUTPUT. These routines determine which driver subroutine to call to perform the specific action. Each set of driver routines consists of an initialization routine, an input routine, and an output routine. One set of drivers is for the SCI port and these routines are called ONSCI, INSCI, and OUTSCI. The second set of drivers is for a DUART and these routines are called ONUART, INUART, and OUTUART. The third set of drivers is for an ACIA and these routines are called ONACIA, INACIA, and OUTACIA.

All I/O communications are controlled by three RAM locations (IODEV, EXTDEV, and HOSTDEV). EXTDEV specifies the external device type (0=none, 1=ACIA, 2=DUART). HOSTDEV specifies which I/O port is used for host communications (0=SCI, 1=ACIA, 3=DUARTB). IODEV instructs the supervisor routine which port/driver routine to use (0=SCI, 1=ACIA, 2=DUART, 3=DUARTB).

The INIT routines set up a serial transmission format of eight data bits, one stop bit, and no parity. For the SCI, the baud rate is set to 9600 for an 8 MHz crystal (2 MHz E-clock). A different baud rate can be achieved by modifying address location \$102B (refer to MCU data sheet, SCI baud rate selection).

The INPUT routine reads from the specified port. If a character is received, the character is returned to accumulator A. If no character is received, a logic zero (0) is returned to accumulator A. This routine does not wait for a character to be received before returning (that function is performed by the INCHAR utility subroutine).

The OUTPUT routine takes the ASCII character in accumulator A and writes the character to the specified I/O port. This routine waits until the character begins transmitting before returning.

3.2.4 Utility Subroutines

Several subroutines exist that are available for performing I/O tasks. A jump table has been set up in ROM directly before the interrupt vectors. To use these subroutines, execute a jump to subroutine (JSR) command to the appropriate entry in the jump table. By default, all I/O performed with these routines are sent to the terminal port. Redirection of the I/O port is achieved by placing the specified value (0=SCI, 1=ACIA, 2=DUARTA, 3=DUARTB) into RAM location IODEV. Utility subroutines available to the user are listed in Table 3-1.

Table 3-1. Utility Subroutine Jump Table

Address	Routine	Description
\$FF7C	.WARMST	Go to ">" prompt point (skip BUFFALO... message).
\$FF7F	.BPCLR	Clear breakpoint table.
\$FF82	.RPRINT	Display user's registers.
\$FF85	.HEXBIN	Convert ASCII character in A register to 4-bit binary number. Shift binary number into SHFTREG from the right. SHFTREG is a 2-byte (4 hexadecimal digits) buffer. If A register is not hexadecimal, location TMP1 is incremented and SHFTREG is unchanged.
\$FF88	.BUFFAR	Read 4-digit hexadecimal argument from input buffer to SHFTREG.
\$FF8B	.TERMAR	Read 4-digit hexadecimal argument from terminal device to SHFTREG.
\$FF8E	.CHGBYT	Write value (if any) from SHFTREG+1 to memory location pointed to by X. (Operation also applicable to EEPROM locations.)
\$FF91	.READBU	Read next character from INBUFF.
\$FF94	.INCBUF	Increment pointer into input buffer.
\$FF97	.DECBUF	Decrement pointer into input buffer.
\$FF9A	.WSKIP	Read input buffer until non-whitespace character found.
\$FF9D	.CHKABR	Monitor input for (CTRL)X, (DELETE), or (CTRL)W requests.
\$FFA0	.UPCASE	If character in accumulator A is lower case alpha, convert to upper case.
\$FFA3	.WCHEK	Test character in accumulator A and return with Z bit set if character is white space (space, comma, tab).
\$FFA6	.DCHEK	Test character in accumulator A and return with Z bit set if character is delimiter (carriage return or white space).

Table 3-1. Utility Subroutine Jump Table (continued)

Address	Routine	Description
\$FFA9	.INIT	Initialize I/O device.
\$FFAC	.INPUT	Read I/O device.
\$FFAF	.OUTPUT	Write I/O device.
\$FFB2	.OUTLHL	Convert left nibble of accumulator A contents to ASCII and output to terminal port.
\$FFB5	.OUTRHL	Convert right nibble of accumulator A contents to ASCII and output to terminal port.
\$FFB8	.OUTA	Output accumulator A ASCII character.
\$FFBB	.OUT1BY	Convert binary byte at address in index register X to two ASCII characters and output. Returns address in index register X pointing to next byte.
\$FFBE	.OUT1BS	Convert binary byte at address in index register X to two ASCII characters and output followed by a space. Returns address in index register X pointing to next byte.
\$FFC1	.OUT2BS	Convert two consecutive binary bytes starting at address in index register X to four ASCII characters and output followed by a space. Returns address in index register X pointing to next byte.
\$FFC4	.OUTCRL	Output ASCII carriage return followed by a line feed.
\$FFC7	.OUTSTR	Output string of ASCII bytes pointed to by address in index register X until character is an end of transmission (\$04).
\$FFCA	.OUTST0	Same as OUTSTR except leading carriage return and line feed is skipped.
\$FFCD	.INCHAR	Input ASCII character to accumulator A and echo back. This routine loops until character is actually received.
\$FFD0	.VECINIT	Used during initialization to preset indirect interrupt vector area in RAM. This routine or a similar routine should be included in a user program which is invoked by the jump to \$B600 feature of BUFFALO.

When accessing BUFFALO utility routines, always reference the routines by the applicable address (\$FF7C through \$FFD0) in the jump table rather than the actual address in the BUFFALO monitor program. Jump table addresses remain the same when a new version of BUFFALO is developed even though the actual addresses of the routine may change. Programs that reference routines by the jump table addresses are not required to be changed to operate on revised versions of the BUFFALO monitor program.

3.2.5 Command Table

The command table consists of three lines for each entry. The first byte is the number of characters in the command name. The second entry is the ASCII command name. The third entry is the starting address of the command module. As an example:

```

FCB      3           3 characters in command name
FCC      'ASM'      ASCII literal command name string
FDB      ASM        Jump address for command module
    
```

Each command in the BUFFALO program is a individual module. Thus, to add or delete commands, all that is required is to include a new command module or delete an existing module and/or delete the entry in the command table. This procedure may be difficult to accomplish with the M68HC11EVBU because the BUFFALO monitor is contained in ROM. However with the standard M68HC11EVB, you may change commands, as this version of the BUFFALO monitor is contained in EPROM.

3.3 INTERRUPT VECTORS

Interrupt vectors residing in MCU internal ROM are accessible as follows. Each vector is assigned a three byte field residing in EVBU memory map locations \$0000-\$00FF. This is where the monitor program expects the MCU RAM to reside. Each vector points to a three byte field which is used as a jump table to the vector service routine. Table 3-2 lists the interrupt vectors and associated three byte field.

Table 3-2. Interrupt Vector Jump Table

Interrupt Vector	Field
Serial Communications Interface (SCI)	\$E0C4 – \$E0C6
Serial Peripheral Interface (SPI)	\$E0C7 – \$E0C9
Pulse Accumulator Input Edge	\$E0CA – \$E0CC
Pulse Accumulator Overflow	\$E0CD – \$E0CF
Timer Overflow	\$E0D0 – \$E0D2
Timer Output Compare 5	\$E0D3 – \$E0D5
Timer Output Compare 4	\$E0D6 – \$E0D8
Timer Output Compare 3	\$E0D9 – \$E0DB
Timer Output Compare 2	\$E0DC – \$E0DE
Timer Output Compare 1	\$E0DF – \$E0E1

Table 3-2. Interrupt Vector Jump Table (continued)

Interrupt Vector	Field
Timer Input Capture 3	\$E0E2 – \$E0E4
Timer Input Capture 2	\$E0E5 – \$E0E7
Timer Input Capture 1	\$E0E8 – \$E0EA
Real Time Interrupt	\$E0EB – \$E0ED
IRQ	\$E0EE – \$E0F0
XIRQ	\$E0F1 – \$E0F3
Software Interrupt (SWI)	\$E0F4 – \$E0F6
Illegal Opcode	\$E0F7 – \$E0F9
Computer Operating Properly (COP)	\$E0FA – \$E0FC
Clock Monitor	\$E0FD – \$E0FF

To use vectors specified in Table 3-2, you must insert a jump extended opcode in the three byte field of the vector required. For an example, for the IRQ vector, the following is performed:

1. Place \$7E (JMP) at location \$00EE.
2. Place IRQ service routine address at locations \$00EF and \$00F0.
3. The following is an example where the IRQ service routine starts at \$0100:

```
$00EE    7E  01  00    JMP IRQ SERVICE
```

During initialization BUFFALO checks the first byte of each set of three locations. If a \$7E jump opcode is not found, BUFFALO will install a jump to a routine called STOPIT. This assures there will be no uninitialized interrupt vectors which would cause undesirable operation during power up and power down. If an interrupt is accidentally encountered, the STOPIT routine will force a STOP instruction sequence to be executed. A user may replace any of the JMP STOPIT instructions with a JMP to a user written interrupt service routine. If a reset is issued via switch S1, BUFFALO will not overwrite these user jump instructions so they need not be re-initialized after every reset.

CHAPTER 4

OPERATING INSTRUCTIONS

4.1 INTRODUCTION

This chapter provides the necessary information to initialize and operate the EVBU. Information consists of the control switch description, operating limitations, command line format, monitor commands, and operating procedures. The operating procedures consist of assembly/disassembly and downloading descriptions and examples.

4.2 CONTROL SWITCH

Use user reset switch S1 to reset the EVBU and MCU circuits. This switch is a momentary action pushbutton switch.

4.3 LIMITATIONS

The default baud rate for the MC68HC11 MCU SCI is 9600, using a 2 MHz E clock. You can reset the baud rate using the memory modify (MM) command to reprogram the BAUD register in the MCU. Or by using instructions in the user program.

The EVBU can transfer data faster than some terminal devices can receive, which at certain times, can cause missing characters on the terminal display screen. Memory display (MD), trace (TRACE), and help (HELP) commands may be affected by this problem. You can either ignore the problem, switch to a slower baud rate, or use a different communications program. When using the MD or TRACE commands, the missing character problem can be resolved by displaying fewer address locations or tracing fewer instructions at a time, respectively.

The monitor program uses the MCU internal RAM located at \$0048-\$00FF. The control registers are located at \$1000-\$103F. The monitor program also uses Output Compare 5 (OC5) for the TRACE instruction, therefore TRACE cannot be used in user programs which use OC5. Since PROCEED AND STOPAT commands indirectly use the TRACE function these commands also rely on the OC5 to XIRQ connection via jumper header J7.

The EVBU allows you to use all the features of the BUFFALO evaluation software, however it should be noted (when designing code) that BUFFALO uses the MCU on-chip RAM locations \$0047-\$00FF leaving approximately 325 bytes for the user (i.e., \$0000-\$0047 and \$0100-\$01FF). 512 bytes of EEPROM (\$B600-\$B7FF) and approximately 325 bytes of RAM (\$0000-\$0047) + (\$0100-\$01FF) are available for user developed software.

Table 4-1 is a lists of the BUFFALO monitor memory map limitations.

Table 4-1. Monitor Memory Map Limitations

Address	Restrictions
\$0000–\$0047	Available to user. (BUFFALO sets default value of the user stack pointer at location \$0047.)
\$0048–\$0065	BUFFALO monitor stack area.
\$0066–\$00C3	BUFFALO variables. (Refer to the buf32.asm file on the EVBU diskette).
\$00C4–\$00FF	Interrupt pseudo vectors (jumps).
\$0100–\$01FF	User available.
\$1000–\$103F	MCU control registers. Although RAM and registers can be moved in the memory map, BUFFALO expects RAM at \$0000 (actually requires \$0048-\$00FF) and registers at \$1000-\$103F.
\$4000	<p>Some versions of EVBs have a D flip-flop addressed at this location. During initialization, BUFFALO 3.2 writes \$00 to location \$4000 and various monitor operations cause \$00 or \$01 to be written to \$4000 to retain compatibility. (Refer to the buf32.asm file on the EVBU diskette for additional information on DFLOP, TARGCO, and HOSTCO).</p> <p>Since the EVBU has no memory or peripherals located at \$4000, these writes should not concern most EVBU users.</p>
\$9800–\$9801	BUFFALO supports serial I/O to a terminal via a ACIA (external IC) located at \$9800 in the memory map. During initialization, BUFFALO 3.2 reads and writes to location \$9800 and 9801 to see if a ACIA is present in the system. If a ACIA is installed on the EVBU wire-wrap area and connected to the MCU, refer to the buf32.asm file on the EVBU diskette to understand implications.
\$D000–\$D00F	BUFFALO supports serial I/O to a terminal and/or host via a DUART (external IC) located at \$D000 in the memory map. During initialization, BUFFALO 3.2 reads and writes to location \$D00C to see if a DUART is present in the system. If a DUART is installed on the EVBU wire-wrap area and connected to the MCU, refer to the buf32.asm file on the EVBU diskette.

4.4 OPERATING PROCEDURES

The EVBU is a simplified debugging/evaluating tool designed for debugging user programs and evaluation of MC68HC11 family devices. Use jumper header J2 to determine whether the BUFFALO monitor prompt is displayed, or if a jump to internal EEPROM is executed. Refer to paragraph 2.3.1 for additional program execution selection information.

At reset, the monitor detects the state of the PE0 line. If a low state is detected, the monitor program is executed and the prompt displayed. If a high state is detected, the monitor automatically jumps directly to EEPROM (address location \$B600) and executes user program code without displaying the monitor prompt.

4.4.1 Debugging/Evaluation

The debugging/evaluation operation lets you debug user code under control of the BUFFALO monitor program. User code can be assembled in one of two methods. The first method assembles code using the BUFFALO monitor one-line assembler.

The second method, you assemble code on a host computer and then download it to the EVBU user RAM or EEPROM in Motorola S-record format. The monitor program is then used to debug the assembled user code.

A download to EEPROM will work if the baud rate is slow enough to allow EEPROM programming. Since erasure and programming both require 10 milliseconds, a slow baud rate (300 baud) will have to be used to ensure enough time between characters. If the EEPROM is bulk erased prior to downloading, 600 baud allows enough time between characters.

4.4.2 Alternate Baud Rates

The following text assumes that a personal computer (PC) is used as the terminal device, and a user program is assembled on the PC to produce an S-record object file which is to be downloaded into EVBU EEPROM. For this example, no assumptions are made about the previous EEPROM contents. During the download operation, BUFFALO determines (on a byte-by-byte basis) whether or not erasure is required prior to programming a downloaded value into each EEPROM location. Since erasure and programming both require 10 milliseconds, a slow baud rate (300 baud) will have to be used to ensure enough time between characters.

At the start of this procedure, the PC will be operating a terminal emulator program such as PROCOMM, KERMIT, MacTerminal, or Red Ryder; and the BUFFALO prompt `>` will be displayed. First change the BAUD register from `$30` (selects default 9600 baud rate for SCI) to `$35` (to select 300 baud) with a memory modify (MM) command as follows:

```
>MM 102B<CR> BOLD entries are user entered on the terminal keyboard.
```

```
102B 30 35<CR>
```

Since the communication baud rate changes when pressing the carriage return `<CR>` key after typing `35`, you may observe a few invalid characters on the terminal display screen which can be ignored.

Next change the communication program baud rate to 300 baud. If using an IBM-PC with a PROCOMM terminal emulator program, use the alt-P window. Hold down the (alt) keyboard key while pressing the p keyboard key. A window appears on the terminal display screen to change the baud rate. If using an Apple Macintosh with a MacTerminal terminal emulator program, use the pull-down menu to change the baud rate.

Next press the keyboard `<CR>` key to resume communications with the EVBU as follows:

```
<CR>  
102B 35<CR>  
>
```

At this point all BUFFALO commands should operate normally except the display will be noticeably slower due to the slow baud rate.

To download the S-record file to the EVBU EEPROM, type the `LOAD T` command and a carriage return as follows:

```
>LOAD T<CR>
```

At this point BUFFALO is waiting for the S-record file from the PC. Instruct the PC to send the S-record file to the EVBU using simple ASCII file transfer protocol. If using an IBM-PC, use the alt-S window to setup the American standard code for information interchange (ASCII) transfer perimeters (this only needs to be performed once). To invoke the file transfer, press the page-up keyboard key (may be shared with the 9 key on the numeric keypad on some PC keyboards), and follow instructions on the display screen. If using a Apple Macintosh, use the pull-down menu to send the file.

Upon completion of the S-record transfer, the following message is displayed on the terminal display screen:

```
done  
>
```

After downloading the S-record file, the EVBU may be reset (via S1) to return to 9600 baud operation. When the EVBU is returned to 9600 baud operation, the terminal emulator must also be changed back to 9600 baud operation.

4.4.3 Monitor Program

The monitor program (BUFFALO) is the resident firmware for the EVBU, which provides a self contained operating environment. The monitor interacts with the user through predefined commands that are entered from a terminal. You can use any of the commands supported by the monitor.

NOTE

EVBU contains no hardware to support the host related commands.
(e.g., ACIA, DUART)

A standard input routine controls the EVBU operation while you enter a command line. Command processing begins only after the command line has been terminated by depressing the keyboard carriage return <CR> key.

4.5 COMMAND LINE FORMAT

The command line format is as follows:

```
><command> [<parameters>]<CR>
```

where:

- > EVBU monitor prompt.
- <command>** Command mnemonic (single letter for most commands).
- <parameters>** Expression or address.
- <CR>** ENTER keyboard key – depressed to enter command.

NOTES

1. The command line format is defined using special characters which have the following syntactical meanings:
 - < > Enclose syntactical variable
 - [] Enclose optional fields
 - []... Enclose optional fields repeated
- These characters are not entered by the user, but are for definition purposes only.
2. Fields are separated by any number of space, comma, or tab characters.
 3. All input numbers are interpreted as hexadecimal.
 4. All input commands can be entered either upper or lower case lettering. All input commands are converted automatically to upper case lettering except for downloading commands sent to the host computer, or when operating in the transparent mode.
 5. A maximum of 35 characters may be entered on a command line. After the 36th character is entered, the monitor automatically terminates the command entry and the terminal CRT displays the message "Too Long".
 6. Command line errors may be corrected by backspacing (CTRL-H) or by aborting the command (CTRL-X or DELETE).
 7. Pressing **<CR>** will repeat the most recent command. The LOAD command is an exception.

4.6 MONITOR COMMANDS

The BUFFALO monitor commands are listed alphabetically, by mnemonic, in Table 4-2. Each of the commands are described in detail following Table 4-2. In most cases the initial single letter of the command mnemonic or a specific symbol can be used. A minimum number of characters must be entered to at least guarantee uniqueness from other commands (i.e., MO = MOVE, ME = MEMORY). If the letter M is entered, BUFFALO uses the first command in Table 4-2 that starts with M.

Additional terminal keyboard functions are as follows:

(CTRL)A	Exit transparent mode or assembler
(CTRL)B	Send break command to host in transparent mode
(CTRL)H	Backspace
(CTRL)J	Line feed <lf>
(CTRL)W	Wait/freeze screen ⁽¹⁾
(CTRL)X	Abort/cancel command
(DELETE)	Abort/cancel command
<CR>	Enter command/repeat last command

NOTES

1. Execution is restarted by any terminal keyboard key.
2. When using the control key with a specialized command such as (CTRL)A, the (CTRL) key is depressed and held, then the A key is depressed. Both keys are then released.

Command line input examples in this chapter are amplified with the following:

BOLD entries are user-entered on the terminal keyboard.

Command line input is entered when the carriage return key <CR> key is depressed.

Typical example of this explanation is:

```
>MD F000 F100<CR>
```

Table 4-2. Monitor Program Commands

Command	Description
ASM [<address>]	Assembler/disassembler
<i>ASSEM</i>	<i>(same as ASM)</i>
BF <addr1> <addr2> <data>	Block fill memory with data
BR [-] [<address>]...	Breakpoint set
<i>BREAK</i>	<i>(same as BR)</i>
BULK	Erase all EEPROM locations
<i>BULKA</i>	<i>(same as BULKALL)</i>
BULKALL	Bulk erase EEPROM + CONFIG register (1)
CALL [<address>]	Execute subroutine
<i>COPY</i>	<i>(same as MOVE)</i>
<i>DUMP</i>	<i>(same as MD)</i>
<i>ERASE</i>	<i>(same as BULK)</i>
<i>FILL</i>	<i>(same as BF)</i>
G [<address>]	Execute program
<i>GO</i>	<i>(same as G)</i>
HELP	Display monitor commands
<i>HOST</i>	<i>(same as TM)</i>
LOAD <T>	Download (S-records*) via terminal port (2)
<i>MEMORY</i>	<i>(same as MM)</i>
MD [<addr1> [<addr2>]]	Dump memory to terminal
MM [<address>]	Memory modify
MOVE <addr1> <addr2> [<dest>]	Move memory to new location
P	Proceed/continue from breakpoint
<i>PROCEED</i>	<i>(same as P)</i>
<i>RD</i>	<i>(same as RM)</i>
<i>READ</i>	<i>(same as MOVE)</i>

Table 4-2. Monitor Program Commands (continued)

Command	Description
<i>REGISTER</i>	<i>(same as RM)</i>
RM [p,x,y,a,b,c,s]	Register modify/display user registers
STOPAT <address>	Stop at address
T [<n>]	Trace \$1-\$FF instructions
TM	Enter transparent mode
<i>TRACE</i>	<i>(same as T)</i>
VERIFY <T>	Compare memory to download data via terminal port
XBOOT [<address1> [<address2>]]	Send program to another M68HC11 via bootstrap mode
?	<i>(same as HELP)</i>
[<address>]/	<i>(same as MM [<address>])</i>
NOTES	
<ol style="list-style-type: none"> 1. On newer MC68HC11 mask sets, CONFIG can only be changed in special test or bootstrap modes of operation. 2. * Refer to Appendix A for S-record information. 	

ASM

Assembler/Disassembler

4.6.1 Assembler/Disassembler

ASM [<address>]

where:

<address> is the starting address for the assembler operation. Assembler operation defaults to internal RAM if no address is given.

The assembler/disassembler is an interactive assembler/editor. Each source line is converted into the proper machine language code and is stored in memory overwriting previous data on a line-by-line basis at the time of entry. In order to display an instruction, the machine code is disassembled and the instruction mnemonic and operands are displayed. All valid opcodes are converted to assembly language mnemonics. All invalid opcodes are displayed on the terminal CRT as "ILLOP".

The syntax rules for the assembler are as follows: (a.) All numerical values are assumed to be hexadecimal. Therefore no base designators (e.g., \$ = hex, % = binary, etc.) are allowed. (b.) Operands must be separated by one or more space or tab characters. (c.) Any characters after a valid mnemonic and associated operands are assumed to be comments and are ignored.

Addressing modes are designated as follows: (a.) Immediate addressing is designated by preceding the address with a # sign. (b.) Indexed addressing is designated by a comma. The comma must be preceded a one byte relative offset (even if the offset is 00), and the comma must be followed by an X or Y designating which index register to use (e.g., LDAA 0,X). (c.) Direct and extended addressing is specified by the length of the address operand (1 or 2 digits specifies direct, 3 or 4 digits specifies extended). Extended addressing can be forced by padding the address operand with leading zeros. (d.) Relative offsets for branch instructions are computed by the assembler. Therefore the valid operand for any branch instruction is the branch-if-true address, not the relative offset.

When a new source line is assembled, the assembler overwrites what was previously in memory. If no new source line is submitted, or if there is an error in the source line, then the contents of memory remain unchanged. Four instruction pairs have the same opcode, so disassembly will display the following mnemonics:

Arithmetic Shift Left (ASL)/Logical Shift Left (LSL) displays as ASL

Arithmetic Shift Left Double (ASLD)/Logical Shift Left Double (LSLD) displays as LSLD

Branch if Carry Clear (BCC)/Branch if Higher or Same (BHS) displays as BCC

Branch if Carry Set (BCS)/Branch if Lower (BLO) displays as BCS

ASM**Assembler/Disassembler**

If the assembler tries to assemble at an address that is not in RAM or EEPROM, an invalid address message "rom-xxxx" is displayed on the terminal CRT (xxxx = invalid address).

Assembler/disassembler subcommands are as follows. If the assembler detects an error in the new source line, the assembler will output an error message and then reopen the same address location.

- / Assemble the current line and then disassemble the same address location.
- ^ Assemble the current line and then disassemble the previous sequential address location.
- <CR> Assemble the current line and then disassemble the next opcode address.
- (CTRL)J Assemble the current line. If there isn't a new line to assemble, then disassemble the next sequential address location. Otherwise, disassemble the next opcode address.
- (CTRL)A Exit the assembler mode of operation.

Examples:

```
>ASM 0100<CR>

0100 STX  $FFFF    >LDAA #55<CR>  Immediate mode addressing, requires #
      86 55                               before operand.
0102 STX  $FFFF    >STAA C0<CR>    Direct mode addressing.
      97 C0
0104 STX  $FFFF    >LDS 0,X<CR>    Index mode, if offset = 0 (,X) will not
      AE 00                               be accepted.
0106 STX  $FFFF    >BRA C500<CR>   Branch out of range message.

Branch out of range
0106 STX  $FFFF    >BRA 0130<CR>   Branch offsets calculated automatically,
      20 28                               address required as branch operand.
0108 STX  $FFFF    >(CTRL)A      Assembler operation terminated.
>
```

NOTE

In the above example memory locations \$0100-\$0108 previously contained \$FF data which disassembles to STX \$FFFF.

BF**Block Fill****4.6.2 Block Fill**

```
BF <address1> <address2> <data>
```

where:

<address1>	Lower limit for fill operation.
<address2>	Upper limit for fill operation.
<data>	Fill pattern hexadecimal value.

The BF command lets you repeat a specific pattern throughout a determined user memory range in RAM or EEPROM. If an invalid address is specified, an invalid address message "rom-xxxx" is displayed on the terminal CRT (xxxx = invalid address).

Examples:

```
>BF 0100 01FF FF<CR>  Fill each byte of memory from 0100 through 01FF with data  
                        pattern FF.
```

```
>BF B700 B700 0<CR>   Set location B700 to 0.
```

BR

Breakpoint Set

4.6.3 Breakpoint Set

BR [-][<address>]...

where:

- [-] by itself removes (clears) all breakpoints.
- [-] proceeding [<address>]... removes individual or multiple addresses from breakpoint table.

The BR command sets the address into the breakpoint address table. During program execution, a halt occurs to the program execution immediately preceding the execution of any instruction address in the breakpoint table. A maximum of four breakpoints may be set. After setting the breakpoint, the current breakpoint addresses, if any, are displayed. Whenever the G, CALL, or P commands are invoked, the monitor program inserts breakpoints into the user code at the address specified in the breakpoint table.

Breakpoints are accomplished by the placement of a software interrupt (SWI) at each address specified in the breakpoint address table. The SWI service routine saves and displays the internal machine state, then restores the original opcodes at the breakpoint locations before returning control back to the monitor program.

SWI opcodes cannot be executed or breakpointed in user code because the monitor program uses the SWI vector. RAM or EEPROM locations can be breakpointed.

Command Formats	Description
BR	Display all current breakpoints.
BR <address>	Set breakpoint.
BR <addr1> <addr2> ...	Set several breakpoints.
BR -	Remove all breakpoints.
BR -<addr1> <addr2>...	Remove <addr1> and add <addr2>.
BR <addr1> - <addr2>...	Add <addr1>, clear all entries, then add <addr2>.
BR <addr1> -<addr2>...	Add <addr1>, then remove <addr2>.

BR
Breakpoint Set**Examples:**

```

>BR 0103<CR>                               Set breakpoint at address location 0103.

0103 0000 0000 0000
>

>BR 0103 0105 0107 0109<CR>               Sets four breakpoints. Breakpoints at same address
                                           results in only one breakpoint being set.

0103 0105 0107 0109
>

>BR<CR>                                       Display all current breakpoints.

0103 0105 0107 0109
>

>BR -0109<CR>                               Remove breakpoint at address location 0109.

0103 0105 0107 0000
>

>BR - 0109<CR>                              Clear breakpoint table and add 0109.

0109 0000 0000 0000
>

>BR -<CR>                                    Remove all breakpoints.

0000 0000 0000 0000
>

>BR E000<CR>                                Only RAM or EEPROM locations can be
                                           breakpointed.
                                           Invalid address message.

rom-E000
0000 0000 0000 0000
>

>BR 0105 0107 0109 0111 0113<CR>           Maximum of four breakpoints can be set.

Full                                         Buffer full message.
0105 0107 0109 0111
>

```

BULK

Erase All EEPROM Locations

4.6.4 Erase All EEPROM Locations

The BULK command lets you erase all MCU EEPROM locations (\$B600-\$B7FF). A delay loop is built in such that the erase time is 10 ms when running at 2 MHz E clock.

NOTE

No erase verification message will be displayed upon completion of the bulk EEPROM erase operation. User must verify erase operation by examining EEPROM locations using the MM or MD command.

Example:

```
>BULK<CR>  
>
```

Bulk erase all MCU EEPROM locations (\$B600-\$B7FF).
Prompt indicates erase sequence completed.

BULKALL

Erase All EEPROM & Config. Reg.

4.6.5 Erase All EEPROM Locations & the CONFIG Register

BULKALL

The BULKALL command lets you erase all MCU EEPROM locations (\$B600-\$B7FF) including the configuration (CONFIG) register location (\$103F) on older MC68HC11A8 MCU mask sets. A delay loop is built in such that the erase time is about 10 ms when running at 2 MHz E clock. The MC68HC11E9 MCU CONFIG register cannot be changed in normal operating modes.

NOTE

No erase verification message will be displayed upon completion of the bulkall EEPROM and configuration register erase operation. User must verify erase operation by examining EEPROM locations or the configuration register location using the MM or MD command.

Example:

```
>BULKALL<CR>
```

Bulk erase all MCU EEPROM (\$B600-\$B7FF) and configuration register (\$103F) locations.

```
>
```

Prompt indicates erase sequence completed.

CALL

Execute Subroutine

4.6.6 Execute Subroutine

```
CALL [<address>]
```

where:

<address> the starting address where user subroutine begins.

The CALL command allows the user to execute a user subroutine program. Execution starts at the current program counter (PC) address location, unless a starting address is specified. Two extra bytes are placed onto the stack before the BUFFALO monitor calls the subroutine so that the first unmatched return from subroutine (RTS) encountered will return control back to the monitor program. Thus any user subroutine can be called and executed via the monitor program. Program execution continues until an unmatched RTS is encountered, a breakpoint is encountered, or the EVBU reset switch S1 is activated (pressed).

EXAMPLE PROGRAM: for CALL, G, P, and STOPAT command examples

```
>ASM 0100<CR>
0100 STX  $FFFF  >LDAA #44<CR>
86 44
0102 STX  $FFFF  >STAA 01FC<CR>
B7 01 FC
0105 STX  $FFFF  >NOP<CR>
01
0106 STX  $FFFF  >NOP<CR>
01
0107 STX  $FFFF  >NOP<CR>
01
0108 STX  $FFFF  >RTS<CR>
39
0109 STX  $FFFF  >(CTRL)A
```

CALL

Execute Subroutine

Example:

>CALL 0100<CR> Execute program subroutine.

P-0100 Y-DEFE X-F4FF A-44 B-FE C-D0 S-0047 Displays register status at time
> RTS encountered (except P register contains original call
 address or a breakpoint address if encountered).

G**Execute Program****4.6.7 Execute Program**

G [<address>]

where:

<address> is the starting address where program execution begins.

The G command allows the user to initiate user program execution (free run in real time). The user may optionally specify a starting address where execution is to begin. Execution starts at the current program counter (PC) address location, unless a starting address is specified. Program execution continues until a breakpoint is encountered, or the EVBU reset switch S1 is activated (pressed).

NOTE

Refer to example program shown on **page 4-16** and insert breakpoints at locations \$0105 and \$0107 for the following G command example.

Example:

```
>G 0100<CR>          Begin program execution at PC address location 0100.  
P-0105 Y-DEFE X-F4FF A-44 B-FE C-D0 S-0047 Breakpoint encountered at  
>                                0105.
```

HELP

Help

4.6.8 Help

HELP

The HELP command enables the user available EVBU command information to be displayed on the terminal CRT for quick reference purposes.

EXAMPLE

>HELP<CR>

```

ASM [<addr>] Line assembler/disassembler.
  /           Do same address.           ^           Do previous address.
  CTRL-J     Do next address.           RETURN      Do next opcode.
  CTRL-A     Quit.
BF <addr1> <addr2> [<data>] Block fill.
BR [-][<addr>] Set up breakpoint table.
BULK Erase the EEPROM.           BULKALL Erase EEPROM and CONFIG.
CALL [<addr>] Call user subroutine. G [<addr>] Execute user code.
LOAD, VERIFY [T] <host download command> Load or verify S-records.
MD [<addr1> [<addr2>]] Memory dump.
MM [<addr>] Memory modify.
  /           Open same address.           CTRL-H or ^ Open previous address.
  CTRL-J     Open next address. SPACE      Open next address.
  RETURN     Quit.           <addr>0      Compute offset to <addr>.
MOVE <s1> <s2> [<d>] Block move.
P Proceed/continue execution.
RM [P, Y, X, A, B, C, or S] Register modify.
T [<n>] Trace n instructions.
TM Transparent mode (CTRL-A = exit, CTRL-B = send break).
CTRL-H Backspace.           CTRL-W Wait for any key.
CTRL-X or DELETE Abort/cancel command.
RETURN Repeat last command.
>
```

LOAD

Load S-Records

4.6.9 Load S-Records

LOAD <host download command> *(NOT APPLICABLE TO EVBU)*

LOAD <T>

where:

<host download command>	download S-records via host port.
<T>	download S-records to EVBU via terminal port.

NOTE

As equipped from the factory the EVBU only supports the LOAD T variation of the load command

The LOAD command moves (downloads) object data in S-record format (see Appendix A) from an external host computer to the EVBU. As the EVBU monitor processes only valid S-record data, it is possible for the monitor to hang up during a load operation. If an S-record starting address points to an invalid memory location, the invalid address message "error addr xxxx" is displayed on the terminal CRT (xxxx = invalid address).

Examples:

>LOAD T<CR>	LOAD command entered to download data from host computer
done	to EVBU via terminal port.
>	
>LOAD T<CR>	LOAD command entered.
error addr E000	Invalid address message.
>	S-records must be downloaded into RAM or EEPROM.

Refer to paragraph 4.8 DOWNLOADING PROCEDURES for additional information pertaining to the use of the LOAD command. Refer to paragraph 4.4.2 Alternate Baud Rates for information pertaining to slower baud rates which are required when downloading directly to EEPROM.

MD

Memory Display

4.6.10 Memory Display

```
MD [<address1> [<address2>]]
```

where:

- <address1> Memory starting address (optional).
- [<address2>] Memory ending address (optional).

The MD command lets you display a block of user memory beginning at address1 and continuing to address2. If address2 is not entered, 9 lines of 16 bytes are displayed beginning at address1. If address1 is greater than address2, the display defaults to the first address. If no addresses are specified, 9 lines of 16 bytes are displayed near the last memory location accessed.

Each displayed line of memory consists of a four digit hexadecimal address (applicable to the memory location displayed), followed by 16 two digit hexadecimal values (contents of the sixteen memory locations), followed by the ASCII equivalents (if applicable) of the the 16 memory locations. Since not all 8-bit values correspond to a displayable ASCII character, some of the character positions at the end of a line may be blank.

MD**Memory Display****EXAMPLES**

>MD E61F<CR>

```
E610 F1 34 02 54 4D EE E4 04 54 45 53 54 FE 29 FF 42 4 TM TEST ) B
E620 55 46 46 41 4C 4F 20 33 2E 32 20 28 69 6E 74 29 UFFALO 3.2 (int)
E630 20 2D 20 42 69 74 20 55 73 65 72 20 46 61 73 74 - Bit User Fast
E640 20 46 72 69 65 6E 64 6C 79 20 41 69 64 20 74 6F Friendly Aid to
E650 20 4C 6F 67 69 63 61 6C 20 4F 70 65 72 61 74 69 Logical Operati
E660 6F 6E 04 57 68 61 74 3F 04 54 6F 6F 20 4C 6F 6E on What? Too Lon
E670 67 04 46 75 6C 6C 04 4F 70 D2 20 04 72 6F 6D 2D g Full Op- rom-
E680 04 43 6F 6D 6D 61 6E 64 3F 04 42 62 64 20 61 72 Command? Bad ar
E690 67 75 60 65 6E 74 04 4E 6F 20 68 6F 73 74 20 70 gument No host p
>
```

>MD 0130 0120<CR>

```
0130 FF FF FF FF FF FF FF FF FF FF FF FF FF FF FF FF
>
```

>MD 0100 0120<CR>

```
0100 86 04 B7 01 FC 01 01 01 39 FF FF FF FF FF FF FF
0110 FF FF FF FF FF FF FF FF FF FF FF FF FF FF FF
0120 FF FF FF FF FF FF FF FF FF FF FF FF FF FF FF
>
```

9

MM

Memory Modify

4.6.11 Memory Modify

MM [<address>]

where:

<address> the memory location at which to start display/modify.

The MM command allows the user to examine/modify contents in user memory at specified locations in an interactive manner. The MM command will also erase any EEPROM location, and will reprogram the location with the corresponding value (EEPROM locations treated as if RAM).

Once entered, the MM command has several submodes of operation that allow modification and verification of data. The following subcommands are recognized.

- (CTRL)J or (SPACE BAR) or + Examine/modify next location.
- (CTRL)H or ^ or - Examine/modify previous location.
- / Reexamine/modify same location.
- <CR> Terminate MM operation.
- O Compute branch instruction relative offset.

If an attempt is made to change an invalid address, the invalid address message "rom" is displayed on the terminal CRT. An invalid address is any memory location which cannot be read back immediately after a change in order to verify that change.

MM**Memory Modify****Examples:**

>MM 0180<CR>	Display memory location 0180.
0180 FF 66/<CR>	Change data at 0180 and reexamine location.
0180 66 55 ^<CR>	Change data at 0180 and backup one location.
017F FF AA<CR>	Change data at 017F and terminate MM operation.
>MM 013C<CR>	Display memory location.
013C FF 018EO<CR> 51	Compute offset, result = \$51.
013C FF	
>MM 0100<CR>	Examine location \$0100.
0100 86 04 B7 01 FC 01	Examine next location(s) using (SPACE BAR).
>MM B700<CR>	Examine EEPROM location \$B700.
B700 FF 52<CR>	Change data at location \$B700.
>MM B700<CR>	Reexamine EEPROM location \$B700.
B700 52	
>	

MOVE

Move Memory

4.6.12 Move Memory

```
MOVE <address1> <address2> [<dest>]
```

where:

- <address1> Memory starting address.
- <address2> Memory ending address.
- [<dest>] Destination starting address (optional).

The MOVE command allows the user to copy/move memory to new memory locations. If the destination is not specified, the block of data residing from address1 to address2 will be moved up one byte. Using the MOVE command on EEPROM locations will program EEPROM cells.

No messages will be displayed on the terminal CRT upon completion of the copy/move operation, only the prompt is displayed.

Example:

```
>MOVE E000 E0FF 0100<CR>   Move data from locations $E000-$E0FF to locations  
                              $0100-$01FF.  
>
```

P Proceed/Continue from Breakpoint

4.6.13 Proceed/Continue

P

This command is used to proceed or continue program execution without having to remove assigned breakpoints. This command is used to bypass assigned breakpoints in a program executed by the G command.

NOTE

Refer to example program shown on **page 4-16** for the following P command example. Breakpoints have been inserted at locations \$0105 and \$0107 (refer to example on **pages 4-16 and 4-17**).

Example:

```
>G 0100<CR>                               Start execution at 0100.

P-0105 Y-DEFE X-F4FF A-44 B-FE C-D0 S-0047 Breakpoint encountered at
                                           0105. Continue execution.

>P<CR>

P-0107 Y-DEFE X-F4FF A-44 B-FE C-90 S-0047 Breakpoint encountered at
                                           0107.

>
```

RM

Register Modify/Display

4.6.14 Register Modify/Display

```
RM [p, y, x, a, b, c, s]
```

The RM command is used to modify the MCU program counter (P), Y index (Y), X index (X), A accumulator (A), B accumulator (B), condition code register (C), and stack pointer (S) register contents.

Examples:

```
>RM<CR>                                Display P register contents.
P-0108 Y-7982 X-FF00 A-44 B-70 C-C0 S-0047
P-0108 0100<CR>                          Modify P register contents.
```

```
>
```

```
>RM X<CR>                                Display X register contents.
P-0100 Y-7982 X-FF00 A-44 B-70 C-C0 S-0047
X-FF00 1000<CR>                          Modify X register contents.
```

```
>
```

```
>RM<CR>                                Display P register contents.
P-0100 Y-7982 X-1000 A-44 B-70 C-C0 S-0047
P-0100 (SPACE BAR)                       Display remaining registers.
Y-7982 (SPACE BAR)
X-1000 (SPACE BAR)
A-44 (SPACE BAR)
B-70 (SPACE BAR)
C-C0 (SPACE BAR)
S-0047 (SPACE BAR)                       Entering a (SPACE BAR) following the stack pointer
>                                          display will terminate RM command.
```

STOPAT

Stop at Address

4.6.15 Stop at Address

STOPAT <address>

where:

<address> The specified user program counter (PC) stop address.

The STOPAT command causes a user program to be executed one instruction at a time until the specified address is encountered. Execution begins with the current user PC address and stops just before execution of the instruction at the specified stop address. The STOPAT command should only be used when the current value of the user PC register is known. (e.g., after a breakpoint is reached or after an RD command is used to set the user PC)

The STOPAT command has an advantage over breakpoints in that a stop address can be a ROM location while breakpoints only operate in RAM or EEPROM locations. Since the STOPAT command traces one instruction at a time with a hidden return to the monitor after each user instruction, some user programs will appear to execute slowly.

The stop address specified in the STOPAT command must be the address of an opcode just as breakpoints can only be set at opcode addresses.

NOTE

Refer to example program shown on **page 4-16** for the following STOPAT command example. The RD command was used prior to this example to set the user PC register to \$0100.

Example:

```
>STOPAT 0108<CR>            Execute example program until $0108 is reached.  
P-0108 Y-DEFE X-F4FF A-44 B-FE C-90 S-0047  
>
```

T**Trace****4.6.16 Trace**

T [<n>]

where:

<n> is the number (in hexadecimal, \$1-FF max.) of instructions to execute. A default value of 1 is used if <n> is not specified.

The T command allows the user to monitor program execution on an instruction-by-instruction basis. The user may optionally execute several instructions at a time by entering a count value (up to \$FF). Execution starts at the current program counter (PC). Each event message line includes a disassembly of the instruction that was traced and a register display showing the CPU state after execution of the traced instruction. The trace command operates by setting the OC5 interrupt to time out after the first cycle of the first user opcode fetched.

NOTE

The RD command was used to set the user PC register to \$FF85 prior to starting the following trace examples.

SINGLE TRACE EXAMPLE

```
>T<CR>
JMP          $E1F7 P-E1F7 Y-FFFF X-FFFF A-44 B-FF C-10 S-0046
>
```

MULTIPLE TRACE EXAMPLES

```
>T 2<CR>
PSHA          P-E1F8 Y-FFFF X-FFFF A-44 B-FF C-10 S-0046
PSHB          P-E1F9 Y-FFFF X-FFFF A-44 B-FF C-10 S-0045
>T 3<CR>
PSHX          P-E1FA Y-FFFF X-FFFF A-44 B-FF C-10 S-0043
JSR  $E19D    P-E19D Y-FFFF X-FFFF A-44 B-FF C-10 S-0041
CMPA  #$61    P-E19F Y-FFFF X-FFFF A-44 B-FF C-19 S-0041
>T 4<CR>
BLT  $E1A7    P-E1A7 Y-FFFF X-FFFF A-44 B-FF C-19 S-0041
RTS          P-E1FD Y-FFFF X-FFFF A-44 B-FF C-19 S-0043
CMPA  #$30    P-E1FF Y-FFFF X-FFFF A-44 B-FF C-19 S-0043
BLT  $E223    P-E223 Y-FFFF X-FFFF A-44 B-FF C-19 S-0043
>
```

TM**Transparent Mode****4.6.17 Transparent Mode**

TM (NOT APPLICABLE TO EVBU)

The TM command connects the EVBU host port to the terminal port, which allows direct communication between the terminal and a host computer. All I/O between the ports are ignored by the EVBU until the exit character is entered from the terminal.

The TM subcommands are as follows:

- (CTRL)A Exit from transparent mode.
- (CTRL)B Send break to host computer.

NOTE

TM command can only be used if a host I/O port is installed on the EVBU wire-wrap area.

Example

```
>TM<CR>          Enter transparent mode.

appslab login: bill<CR>  Host computer login response.
Password:xxxxxxx<CR>    Host computer password.

"System Message"

$
.
.
.
$(CTRL)A          Task completed. Enter exit command.
>                  Exit transparent mode.
```

VERF

Verify

4.6.18 Verify

VERIFY <host download command> *(NOT APPLICABLE TO EVBU)*

VERIFY <T>

where:

<host download command> compare memory to host port download data.

<T> compare memory to terminal port download data.

NOTE

As equipped from the factory the EVBU only supports the VERF <T> variation of the verify command.

The VERIFY command is similar to the LOAD command except that the VERIFY command instructs the EVBU to compare the downloaded S-record data to the data stored in memory.

EXAMPLES DESCRIPTION

```
>VERIFY T<CR>
Done
>
```

Enter verify command.
Verification completed.

```
>VERIFY T<CR>
error addr E000
>
```

Enter verify command.
Mismatch encountered.
Error message displaying first address that failed to verify.

Refer to the downloading procedures at the end of this chapter for additional information pertaining to the use of the VERF command.

XBOOT

Transfer Data Bootstrap Mode

4.6.19 Transfer Data Bootstrap Mode

```
XBOOT [<address1> [<address2>]]
```

where:

- <address1> Starting address.
- <address2> Ending address.

The XBOOT command loads/transfers a block of data from address1 through address2 via the serial communications interface (SCI) to another MC68HC11 MCU device which has been reset in the bootstrap mode. A leading control character of \$FF is sent prior to sending the data block. This control character is part of the bootstrap mode protocol and establishes the baud rate for the rest of the transfer.

If only one address is provided, the address will be used as the starting address and the block size will default to 256 bytes. If no addresses are provided, the block of addresses from \$C000 through \$C0FF is assumed by the BUFFALO monitor program.

NOTE

The MC68HC11A8 MCU requires a fixed block size of 256 bytes for bootloading while the MC68HC11E9 MCU can accept a variable length block of 1 to 512 bytes.

The XBOOT command generates SCI transmitter output signals at 7812.5 baud which are intended for another MC68HC11 MCU device operating in the bootstrap mode. These signals appear as nonsense data to the terminal display used for normal communication with the EVBU. After using the XBOOT command the EVBU must be reset by pressing the reset switch S1 before normal communications can resume.

XBOOT

Transfer Data Bootstrap Mode

The following procedure describes the use of the XBOOT command. Before initiating the XBOOT command, the EVBU should be prepared as follows:

1. Cut J9 cut-trace short on PCB solder side at location J9.
2. Install fabricated jumper on jumper header J9, pins 1 and 2.

After preparing the EVBU, perform the following:

1. Assemble or fill EVBU MCU EEPROM (locations \$B600-\$B6FF) with program to be bootloaded (transmitted/transferred) to target MC68HC11 MCU device.
2. Enter XBOOT command and addresses without pressing carriage return <CR> key as follows:

>XBOOT B600 B6FF(Do not press the ENTER key.)

3. Remove previously installed fabricated jumper from jumper header J9.
4. Connect jumper wire from jumper header J9 pin 2 to RxD input of target MC68HC11 MCU device.
5. Reset target MC68HC11 MCU device in bootstrap mode.
6. Press carriage return <CR> key to invoke XBOOT command.

Since TxD is not connected to the terminal, the user will not observe any changes on the terminal display CRT. The bootload process takes approximately a third of a second to finish.

7. Disconnect jumper wire installed in step d.
8. Install fabricated jumper removed in step c.
9. Press EVBU reset switch S1 to restore normal EVBU operation.

4.7 ASSEMBLY/DISASSEMBLY PROCEDURES

The assembler/disassembler is an interactive assembler/editor. Each source line is converted into the proper machine language code and is stored in memory overwriting previous data on a line-by-line basis at the time of entry. In order to display an instruction, the machine code is disassembled and the instruction mnemonic and operands are displayed. All valid opcodes are converted to assembly language mnemonics. All invalid opcodes are displayed on the terminal CRT as "ILLOP".

The syntax rules for the assembler are as follows:

- All numerical values are assumed to be hexadecimal. Therefore no base designators (e.g., \$ = hex, % = binary, etc.) are allowed.
- Operands must be separated by one or more space or tab characters.
- Any characters after a valid mnemonic and associated operands are assumed to be comments and are ignored.

Addressing modes are designated as follows:

- Immediate addressing is designated by preceding the address with a # sign.
- Indexed addressing is designated by a comma. The comma must be preceded a one byte relative offset (even if the offset is 00), and the comma must be followed by an X or Y designating which index register to use (e.g., LDAA 0,X).
- Direct and extended addressing is specified by the length of the address operand (1 or 2 digits specifies direct, 3 or 4 digits specifies extended). Extended addressing can be forced by padding the address operand with leading zeros.
- Relative offsets for branch instructions are computed by the assembler. Therefore the valid operand for any branch instruction is the branch-if-true address, not the relative offset.

When a new source line is assembled, the assembler overwrites what was previously in memory. If no new source line is submitted, or if there is an error in the source line, then the contents of memory remain unchanged. Four instruction pairs have the same opcode, so disassembly will display the following mnemonics:

- Arithmetic Shift Left (ASL)/Logical Shift Left (LSL) displays as ASL
- Arithmetic Shift Left Double (ASLD)/Logical Shift Left Double (LSLD) displays as LSLD
- Branch if Carry Clear (BCC)/Branch if Higher or Same (BHS) displays as BCC
- Branch if Carry Set (BCS)/Branch if Lower (BLO) displays as BCS

If the assembler tries to assemble at an address that is not in RAM or EEPROM, an invalid address message "rom-xxxx" is displayed on the terminal CRT (xxxx = invalid address).

Assembler/disassembler subcommands are as follows. If the assembler detects an error in the new source line, the assembler will output an error message and then reopen the same address location.

- / Assemble the current line and then disassemble the same address location.
- ^ Assemble the current line and then disassemble the previous sequential address location.
- <CR> Assemble the current line and then disassemble the next opcode address.
- (CTRL)J Assemble the current line. If there isn't a new line to assemble, then disassemble the next sequential address location. Otherwise, disassemble the next opcode address.
- (CTRL)A Exit the assembler mode of operation.

4.8 DOWNLOADING PROCEDURES

This portion of text describes the EVBU downloading procedures. Downloading operations allow Motorola's S-record files to be transferred from a personal computer to the EVBU or to be verified against data in EVBU memory. S-record files are made up of data and checksum values in a special format which facilitates downloading. Appendix A describes the S-record format in detail.

In a normally configured EVBU, all data transfers including monitor communications and download data utilize the terminal I/O port connector P1. Since there are no separate host communication ports available on the EVBU, only the LOAD <T> and VERIFY <T> variations of the load and verify commands are applicable.

The setup for downloading includes a personal computer (e.g., IBM-PC or Macintosh), a serial interface cable to connect the personal computer to the EVBU connector P2, and the EVBU with an applicable power source. A software terminal emulator program is also required. Some typical terminal emulator programs for the IBM-PC include PROCOMM and KERMIT. Typical terminal emulator programs for the Macintosh include MacTerminal and Red Ryder.

S-record programs for downloading are created by assembling programs on the personal computer (PC). The steps needed to develop a program are described briefly as follows:

1. Assembly language program is entered into a text file on the PC. A text editor is used to create this text file which is called a source program.
2. An assembler program operating on the PC is used to translate the source program into an S-record object file and/or listing file. Buf32.asm file on the EVBU diskette is an example of a large listing.
3. After the creation of the S-record files, the files are downloaded to the EVBU as shown in the following step-by-step procedures.

4.8.1 Apple Macintosh (with MacTerminal) to EVBU

The MacTerminal downloading program in this application is used as a terminal emulator for the Apple Macintosh computer. To download a Motorola S-record file from the Apple Macintosh computer to the EVBU, perform the following steps:

1. Select the following menu Terminal Settings:

Terminal:	TTY
Cursor Shape:	Underline
Line Width:	80 Columns
Select:	On Line
	Auto Repeat
Click on:	OK

2. Select the following menu Compatibility Settings:

Baud rate:	9600 (same as EVBU)
Bits per Character:	8 Bits
Parity:	None
Handshake:	None
Connection:	Modem or Another Computer
Connection Port:	Modem or Printer
Click on:	OK

3. Select the following menu File Transfer Settings:

Settings for Pasting or Sending Text:	Word Wrap Outgoing Text
File Transfer Protocol:	Text
Settings for Saving Lines Off Top:	Retain Line Breaks
Click on:	OK

4. Apply power to the EVBU.
5. Press Apple Macintosh computer keyboard carriage return <CR> key to display applicable EVBU monitor prompt.
6. Apple Macintosh computer displays the > prompt.
7. Enter EVBU monitor download command as follows:



>LOAD T<CR>

8. Operate pull-down File menu, and select (choose): Send File ...
9. Use dialog box and select applicable S-record object file.

Click on: Send

Motorola S-record file is now transferred to the EVBU.

NOTE

S-record file is not displayed during the file transfer to the EVBU.

Upon completion of the S-record transfer, the following message is displayed:

done

>

NOTE

The EVBU may have to be reset to regain monitor control depending on the version of BUFFALO and how the file transfer program terminates the download operation.

There is a problem which occurs when using the EVBU with the MacTerminal program when performing a downloading operation. The MacTerminal program sends a carriage return and line feed characters at the end of the downloaded S-record file. The EVBU monitor treats this as a erroneous command and the EVBU will have to be reset to regain monitor control.

4.8.2 Apple Macintosh (with Red Ryder) to EVBU

The Red Ryder downloading program in this application is also used as a terminal emulator for the Apple Macintosh computer. To download a Motorola S-record file from the Apple Macintosh computer to the EVBU, perform the following steps:

1. Launch Red Ryder program.
2. Set up computer program to match EVBU baud rate (typically) as follows:
9600 baud, no parity, 8-bits, 1-stop bit, full duplex
3. Apply power to EVBU.
4. Press Apple Macintosh computer keyboard carriage return <CR> key to display applicable EVBU monitor prompt.
5. Enter EVBU monitor download command as follows:
>LOAD T<CR>
6. Operate pull-down File menu, and select (choose):
Send File – ASCII...
7. Use dialog box and select applicable S-record object file.
Click on: Send
Motorola S-record file is now transferred to the EVBU.

NOTE

S-record file is not displayed during the file transfer to the EVBU.

Upon completion of the S-record transfer, the following message is displayed:

done

>



4.8.3 IBM-PC (with KERMIT) to EVBU

To perform the IBM-PC to EVBU downloading procedure with KERMIT, perform/observe the following:

EXAMPLE	DESCRIPTION
C> KERMIT <CR> IBM-PC Kermit-MS VX.XX Type ? for help	IBM-PC prompt. Enter KERMIT program.
Kermit-MS> SET BAUD 9600 <CR> Kermit-MS> CONNECT <CR>	Set IBM-PC baud rate. Connect IBM-PC to EVBU.
[Connecting to host, type Control-] C to return to PC]	
<CR> > LOAD T <CR> entered.	EVBU download command (via terminal port)
(CTRL)]C Kermit-MS> PUSH <CR>	
The IBM Personal Computer DOS Version X.XX (C)Copyright IBM Corp 1981, 1982, 1983	
C> TYPE (File Name) > COM1 <CR>	Motorola S-record file name.
C> EXIT <CR>	S-record downloading completed.
Kermit-MS> CONNECT <CR>	Return to EVBU monitor program.
>(CTRL)]C Kermit-MS> EXIT <CR>	Exit KERMIT program.

4.8.4 IBM-PC (with PROCOMM) to EVBU

To perform the IBM-PC to EVBU downloading procedure with PROCOMM, perform/observe the following:

1. Start the PROCOMM.EXE program.
2. Setup PROCOMM to match EVBU baud rate and protocol (type (Alt)P, then the number 5) as follows:
 - 9600 baud, no parity, 8-bits, 1-stop bit, full duplex
3. Setup ASCII transfer parameters (type (Alt)S, then the number 6) as follows:
 - Echo Local – Yes
 - Expand Blank Lines – Yes
 - Pace Character – 0
 - Character pacing – 25 (1/1000 second)
 - Line Pacing – 10
 - CR Translation – None
 - LF Translation – None
4. Apply power to EVBU.
5. Press IBM-PC keyboard carriage return <CR> key to display applicable EVBU monitor prompt.
6. Enter EVBU monitor download command as follows:
 - >LOAD T<CR>
7. Instruct PROCOMM to send the S-record file by pressing the Pg Up key on the PC, then follow PROCOMM instructions on the display screen to select the S-record file. (Use the ASCII transfer protocol.)

Motorola S-record file is now transferred to the EVBU.

Upon completion of the S-record transfer, the following message is displayed:

done

>

CHAPTER 5

HARDWARE DESCRIPTION

5.1 INTRODUCTION

This chapter provides an overall general description of the EVBU hardware. This description is supported by a simplified block diagram (Figure 5-1). The EVBU schematic diagram, located in Chapter 6, can also be referred to for the following descriptions.

5.2 GENERAL DESCRIPTION

Overall evaluation/debugging control of the EVBU is provided by the BUFFALO monitor program residing in the resident microcontroller (MCU) ROM. The wire-wrap area interface is provided by the MCU device. RS-232C terminal I/O port interface circuitry provides communication and data transfer operations between the EVBU and external terminal/host computer devices.

5.2.1 Microcontroller

The EVBU resident M68HC11E9 MCU device (U3) is factory configured for the single-chip mode of operation. The single-chip mode is accomplished by +5 Vdc applied to the MCU MODB pin, and ground applied to the MCU MODA pin during reset.

The EVBU can be reconfigured for either the expanded-multiplexed, special-bootstrap, or special-test modes of operation via jumper headers J3 and J4. For expanded-multiplexed and special-test modes of operation, additional circuitry must be implemented on the EVBU wire-wrap area to support the two modes. The EVBU can be reconfigured for the special-bootstrap mode of operation without additional circuitry.

The MCU configuration (CONFIG) register (implemented in EEPROM) is programmed such that the ROMON bit is set for EVBU operations. When this bit is set, MCU internal ROM is enabled, and that memory space becomes internally accessed space. This allows the memory at \$D000-\$FFFF to contain the BUFFALO monitor program.

The monitor program uses the MCU internal RAM located at \$0048-\$00FF. The control registers are located at \$1000-\$103F.

The EVBU allows the user to use all the features of the monitor BUFFALO program, however it should be noted that the monitor program uses the MCU on-chip RAM locations \$0048-\$00FF leaving approximately 325 bytes of RAM for the user (i.e., \$0000-\$0047 and \$0100-\$01FF). 512 bytes of EEPROM are also available for user programs.

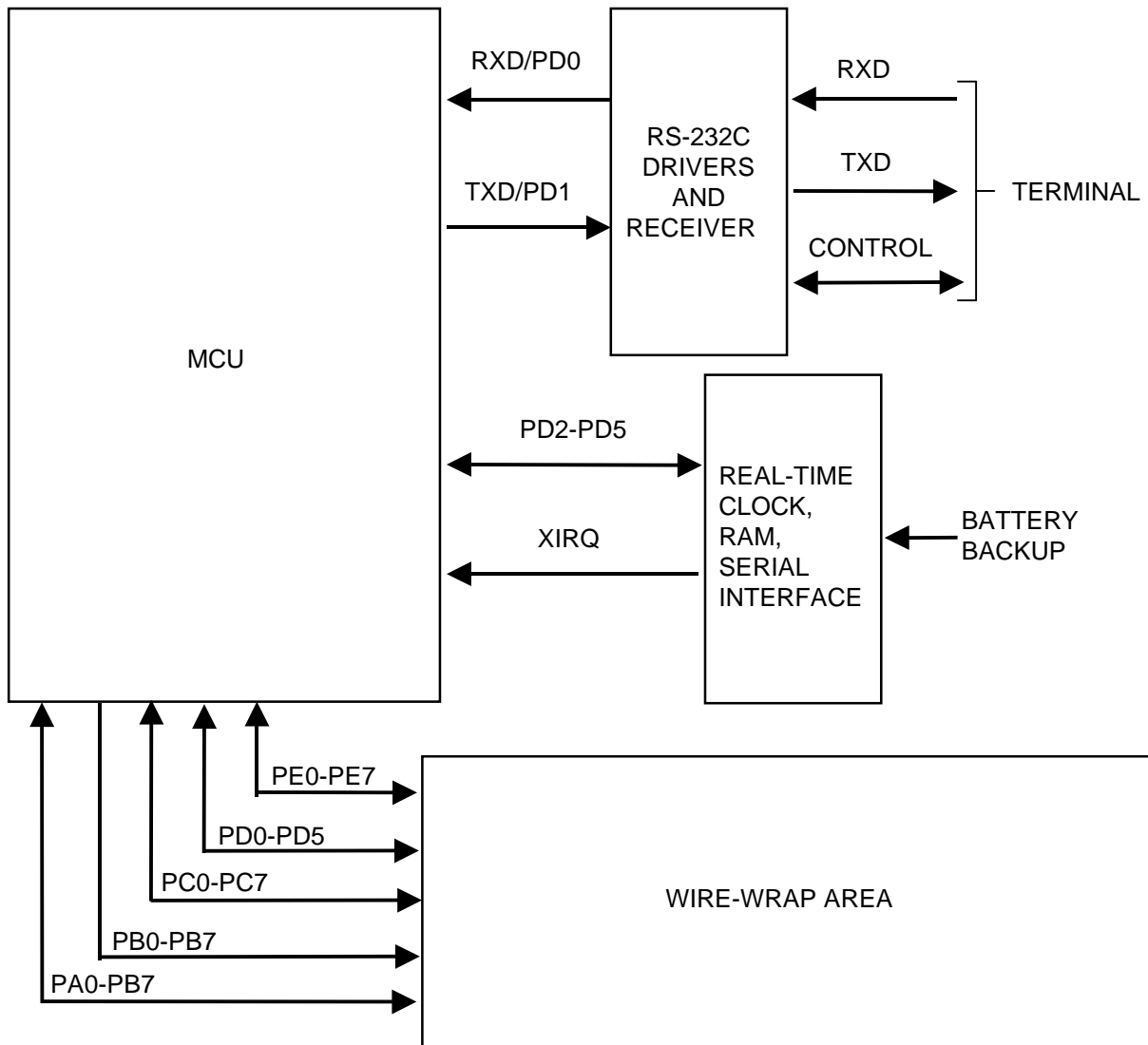

Figure 5-1. EVBU Block Diagram

5.2.2 Memory

The EVBU memory map is a single map design reflecting the resident MC68HC11E9 MCU device. The EVBU is configured for single-chip mode of operation, but can be reconfigured for expanded-multiplexed, special-bootstrap, or special-test modes of operation. Refer to the MC68HC11E9 HCMOS Single-Chip Microcontroller Advanced Information Data Book (*MC68HC11E9/D*) or Programming Reference Guide (*MC68HC11E9RG/AD*) for the specific memory map information on the four modes of operation.

5.2.3 Real-Time Clock + RAM with Serial Interface

An HCMOS real-time clock/calendar, 32 x 8 static RAM, and a synchronous serial interface for MCU communications is accomplished via a user-supplied MC68HC68T1 device (U5). Refer to the MC68HC68T1 Real-Time Clock plus RAM with Serial Interface data sheet (*MC68HC68T1/D*) for additional device information.

5.2.4 Terminal I/O Port Interface

The EVBU uses a +5 volt RS-232C driver/receiver device (U4) to communicate to a terminal via the EVBU terminal I/O port. The terminal I/O port baud rate defaults to 9600 baud via the MCU SCI. This baud rate can be changed by software by reprogramming the MCU BAUD register.

The terminal I/O port is also used as a host computer I/O port for downloading Motorola S-records via BUFFALO monitor commands.

CHAPTER 6

SUPPORT INFORMATION

6.1 INTRODUCTION

This chapter provides the connector signal descriptions, parts list with associated parts location diagram, and schematic diagrams for the EVBU.

6.2 CONNECTOR SIGNAL DESCRIPTIONS

The EVBU provides two MCU Input/Output (I/O) connectors P4 and P5. Connector P4 is used to interconnect the MCU I/O to a target system environment, or a convenient access to the MCU I/O for user applications. Connector P5 is used to interconnect the MCU I/O to the EVBU wire-wrap area.

Connector P1 interconnects an external power supply to the EVBU. Connector P2 is provided to facilitate interconnection of a terminal and/or host computer. Connector P3 connects an external battery for battery backup purposes.

Pin assignments for the above connectors (P1 through P5) are identified in Tables 6-1 through 6-4. Connector signals are identified by pin number, signal mnemonic, and signal name and description.

Table 6-1. Input Power Connector (P1) Pin Assignments

Pin Number	Signal Mnemonic	Signal Name And Description
1	+5 V	+5 Vdc Power – Input voltage (+5 Vdc @ 50 mA) used by the EVBU logic circuits.
2	GND	Ground

Table 6-2. Terminal I/O Port Connector (P2) Pin Assignments

Pin Number	Signal Mnemonic	Signal Name And Description
1	GND	PROTECTIVE GROUND
2	RXD	RECEIVED DATA – Serial data input line.
3	TXD	TRANSMITTED DATA – Serial data output line.
4	NC	Not connected.
5	CTS	CLEAR TO SEND – An output signal used to indicate ready-to-transfer data status. This pin is connected to both DSR pin 6 and DCD pin 8.
6	DSR	DATA SET READY – An output signal used to indicate an on-line/in-service/active status. This pin is connected to both CTS pin 5 and DCD pin 8.
7	SIG-GND	SIGNAL GROUND – This line provides signal ground or common return connection (common ground reference) between the EVBU and RS-232C compatible terminal.
8	DCD	DATA CARRIER DETECT – An output signal used to indicate an acceptable received line (carrier) signal has been detected. This pin is connected to both CTS pin 5 and DSR pin 6.
9-19	NC	Not connected.
20	DTR	DATA TERMINAL READY – An input line used to indicate an on-line/in-service/active status.
21-25	NC	Not connected.

Table 6-3. Battery Backup Connector (P3) Pin Assignments

Pin Number	Signal Mnemonic	Signal Name And Description
1	+	+3 Vdc Power – Input voltage (+3.0 Vdc @ 25 μ A) used by the EVBU MC68HC68T1 real-time clock battery backup feature.
2	–	Ground

Table 6-4. MCU I/O Port Connectors (P4 and P5) Pin Assignments

Pin Number	Signal Mnemonic	Signal Name And Description
1	GND	Ground
2	MODB /	MODE B – An input control line used in conjunction with the MODA pin to select the MCU operating mode.
	VSTBY	STANDBY VOLTAGE – An input MCU RAM standby power line.
3	MODA /	MODE A – An input control line used in conjunction with the MODB pin to select the MCU operating mode.
	LIR*	LOAD INSTRUCTION REGISTER – An open-drain output signal used to indicate an instruction is starting.
4	STRA /	STROBE A – An input edge detecting signal for parallel I/O device handshaking in the single-chip mode of operation.
	AS	ADDRESS STROBE – An output control line used to demultiplex port C address and data signals in the expanded multiplexed mode of operation.
5	E	ENABLE CLOCK – An output control line used for timing reference. E clock frequency is one fourth the frequency of the XTAL and EXTAL pins.
6	STRB /	STROBE B – An output strobe signal for parallel I/O device handshaking in the single-chip mode of operation.
	R/W*	READ/WRITE – An output control line used to control the direction of transfers on the MCU external data bus in the expanded multiplexed mode of operation.
7	EXTAL	EXTERNAL CLOCK INPUT – An input clock signal used to control the MCU internal clock generator. The frequency applied to this pin must be four times higher than the desired E clock rate.

Table 6-4. MCU I/O Port Connectors (P4 and P5) Pin Assignments (continued)

Pin Number	Signal Mnemonic	Signal Name And Description
8	XTAL	CRYSTAL DRIVER – An output clock signal used to drive the EXTAL input of another MC68HC11 MCU device.
9, 10, 11, 12, 13, 14, 15, 16	PC0/AD0, PC1/AD1, PC2/AD2, PC3/AD3, PC4/AD4, PC5/AD5, PC6/AD6, PC7/AD7	PORT C (bits 0-7) – General purpose I/O lines.
17	RESET*	RESET – An active low bidirectional control line used to initialize the MCU.
18	XIRQ*	NON-MASKABLE INTERRUPT – An active low input line used to request asynchronous non-maskable interrupts to the MCU.
19	IRQ*	INTERRUPT REQUEST – An active low input line used to request asynchronous interrupts to the MCU.
20, 21, 22, 23, 24, 25	PD0/RXD, PD1/TXD, PD2/MISO, PD3/MOSI, PD4/SCK, PD5/SS*	PORT D (bits 0-5) – General purpose I/O lines. These lines can be used with the MCU Serial Communications Interface (SCI) and Serial Peripheral Interface (SPI).
26, 27	PA7/OC1, PA6/OC2	PORT A (bits 7, 6) – General purpose I/O lines and/or timer signals.
28	NC	Not connected.
29, 30, 31, 32, 33, 34	PA5/OC3, PA4/OC4, PA3/OC5, PA2/IC1, PA1/IC2, PA0/IC3	PORT A (bits 5-0) – General purpose I/O lines and/or timer signals.
35, 36, 37, 38, 39, 40, 41, 42	PB7/A15 PB6/A14 PB5/A13 PB4/A12 PB3/A11 PB2/A10 PB1/A9 PB0/A8	PORT B (bits 7-0) – General purpose output lines.

Table 6-4. MCU I/O Port Connectors (P4 and P5) Pin Assignments (continued)

Pin Number	Signal Mnemonic	Signal Name And Description
43, 44, 45, 46, 47, 48, 49, 50	PE0, PE4, PE1, PE5, PE2, PE6, PE3, PE7	PORT E (bits 0-7) – General purpose input and/or A/D channel input lines.
51	VRL	VOLTAGE REFERENCE LOW – Input reference supply voltage (low) line for the MCU analog-to-digital (A/D) converter.
52	VRH	VOLTAGE REFERENCE HIGH – Input reference supply voltage (high) line for the MCU A/D converter.
53 – 56	SPARE	Spare pins (see schematic diagram).
57, 58	VCC	+5 Vdc
59, 60	GND	Ground

6.3 PARTS LIST

Table 6-5 lists the components of the EVBU by reference designation order. The reference designation is used to identify the particular part on the parts location diagram (Figure 6-1) that is associated with the parts list table. This parts list reflects the latest issue of hardware at the time of printing.

Table 6-5. EVBU Parts List

Reference Designation	Component Description
	Printed Wiring Board (PWB), M68HC11EVBU
C1, C10, C12-C14	Capacitor, electrolytic, 10 μ F @ 63 Vdc, +/-20%
C2-C4, C8, C9, C11	Capacitor, 0.1 μ F @ 50 Vdc, +/-20%
C5, C6	Capacitor, 27 pF @ 50 Vdc, +/-20% (user-supplied capacitors) For custom MCU operating frequency, replace ceramic resonator X1 with crystal and install C5 and C6 capacitors. (27 pF values are for 8 MHz operation.) Refer to MC68HC11E9 data sheet for X1, C5, and C6 values for specific operating frequencies.
C7	Capacitor, 1.0 μ F @ 50 Vdc, +/-20%
C15, C16	Capacitor, 10 pF @ 50 Vdc, +/-20%
D2 (user-supplied diode)	Diode jumper feed-thru holes with trace: For RTC battery backup, cut solder side cut trace and install 1N4001 diode.
D1, D3, D4 (user-supplied diodes)	Diode jumper feed-thru holes with trace: For RTC battery backup, cut solder side cut trace and install three 1N4148 diodes
J1, J2	Header, jumper, single row post, 3 pin, Apronics # 929705-01-03
J4, J8-J13, J15	Header, jumper, single row post, 2 pin, Apronics # 929705-01-02 (PCB header feed-thru holes with cut trace.) For jumper installation, cut solder side cut trace and install fabricated jumper on component side jumper header as required.
J3, J5-J7, J14	Header, jumper, single row post, 2 pin, Apronics # 929705-01-02 (PCB header feed-thru holes without cut trace.)
J15 (user-supplied jumper header)	Jumper header feed-thru holes with cut trace: For jumper header installation, cut solder side cut trace, install jumper header on component side, and install fabricated jumper on jumper header as required. Header, jumper, single row post, 2 pin, Apronics # 929705-01-02

Table 6-5. EVBU Parts List (continued)

Reference Designation	Component Description
P1	Terminal block, 2S series, Augat RDI # 2SV-02 (power supply connector)
P2	Connector, cable, 25-pin, ITT # DBP-25SAA (terminal I/O port connector)
P3 (user-supplied header)	Header, jumper, single row post, 2 pin, Apronics # 929705-01-02 (real-time clock backup battery connector)
P4	Header, double row post, 60 pin, Apronics # 929715-01-30 (MCU I/O port connector # 1)
P5 (user-supplied header)	Header, double row post, 60 pin, Apronics # 929715-01-30 (MCU I/O port connector # 2)
R1, R4	Resistor, 47k ohm, 5%, 1/4W
R2	Resistor, 10M ohm, 5%, 1/4W
R3, R5	Resistor, 1k ohm, 5%, 1/4W
R6	Resistor, 22M ohm, 5%, 1/4W
RN1, RN2	Resistor, five 47k ohm, Allen-Bradley # 106A473
S1	Switch, pushbutton, SPDT, ITT # D60303
TP1-TP6 (user-supplied header)	Test point feed-thru hole (6 each): Header, single row post, 1 pin, Apronics # 929705-01-01
U1 (user-supplied regulator)	I.C., MC78L05C, voltage regulator, low current
U2	I.C., MC34064, voltage detector, 3.80-4.20 Vdc
U3	I.C., MC68HC11E9FN1, MCU
U4	I.C., MC145407, +5V – only driver/receiver, EIA-232-D (formerly RS-232C)
U5	I.C., MC68HC68T1, real-time clock (RTC) + RAM with serial interface (user-supplied RTC)
XU3	Socket, PC mount, 52 pin, PLCC, AMP # 821-575-1 (use with U3)
XU5	Socket, 16 pin, DIP, Robinson Nugent # ICL-163-S6-TG (use with U5)
X1	Ceramic resonator, MCU, 8.0 MHz, Panasonic # EFO-GC8004A4, Fox # FSC8.00
Y1	Quartz oscillator, 32.768 Khz Fox # NC38-32.768KHz
	Fabricated jumper, Apronics # 929955-00 (use with jumper headers J1, J2, and J7)

6.4 DIAGRAMS

Figure 6-1 is the EVBU parts location diagram. Figure 6-2 is the EVBU schematic diagram.

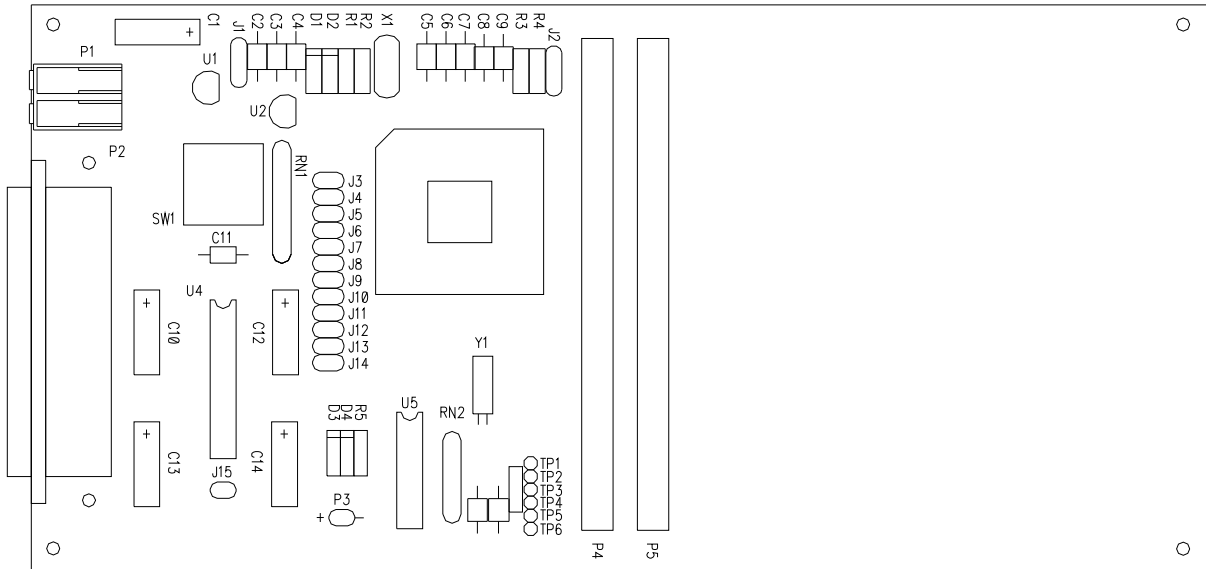

Figure 6-1. EVBU Parts Location Diagram



Figure 6-2. EVBU Schematic Diagram (Sheet 1 of 3)



Figure 6-2. EVBU Schematic Diagram (Sheet 2 of 3)





Figure 6-2. EVBU Schematic Diagram (Sheet 3 of 3)



APPENDIX A

S-RECORD INFORMATION

A-1. INTRODUCTION

The S-record format for output modules was devised for the purpose of encoding programs or data files in a printable format for transportation between computer systems. The transportation process can thus be visually monitored and the S-records can be more easily edited.

A-2 S-RECORD CONTENT

When viewed by the user, S-records are essentially character strings made of several fields which identify the record type, record length, memory address, code/data, and checksum. Each byte of binary data is encoded as a 2-character hexadecimal number: the first character representing the high-order 4 bits, and the second the low-order 4 bits of the byte.

The 5 fields which comprise an S-record are shown below:

TYPE	RECORD LENGTH	ADDRESS	CODE/DATA	CHECKSUM
------	---------------	---------	-----------	----------

where the fields are composed as follows:

Field	Printable Characters	Contents
Type	2	S-record type – S0, S1, etc.
Record length	2	The count of the character pairs in the record, excluding the type and record length.
Address	4, 6, or 8	The 2-, 3-, or 4-byte address at which the data field is to be loaded into memory.
Code/data	0-2n	From 0 to n bytes of executable code, memory load-able data, or descriptive information. For compatibility with teletypewriters, some programs may limit the number of bytes to as few as 28 (56 printable characters in the S-record).
Checksum	2	The least significant byte of the one's complement of the sum of the values represented by the pairs of characters making up the record length, address, and the code/data fields.

Each record may be terminated with a CR/LF/NULL. Additionally, an S-record may have an initial field to accommodate other data such as line numbers generated by some time-sharing systems.

Accuracy of transmission is ensured by the record length (byte count) and checksum fields.

A-3 S-RECORD TYPES

Eight types of S-records have been defined to accommodate the several needs of the encoding, transportation, and decoding functions. The various Motorola upload, download, and other record transportation control programs, as well as cross assemblers, linkers, and other file-creating or debugging programs, utilize only those S-records which serve the purpose of the program. For specific information on which S-records are supported by a particular program, the user manual for that program must be consulted.

NOTE

The EVBU monitor supports only the S1 and S9 records. All data before the first S1 record is ignored. Thereafter, all records must be S1 type until the S9 record terminates data transfer.

An S-record format module may contain S-records of the following types:

S0	The header record for each block of S-records. The code/data field may contain any descriptive information identifying the following block of S-records. The address field is normally zeroes.
S1	A record containing code/data and the 2-byte address at which the code/data is to reside.
S2-S8	Not applicable to EVBU.
S9	A termination record for a block of S1 records. The address field may optionally contain the 2-byte address of the instruction to which control is to be passed. If not specified, the first entry point specification encountered in the object module input will be used. There is no code/data field.

Only one termination record is used for each block of S-records. Normally, only one header record is used, although it is possible for multiple header records to occur.

A-4 S-RECORD CREATION

S-record format programs may be produced by several dump utilities, debuggers, or several cross assemblers or cross linkers. Several programs are available for downloading a file in S-record format from a host system to an 8-bit or 16-bit microprocessor-based system.

A-5 S-RECORD EXAMPLE

Shown below is a typical S-record format module, as printed or displayed:

```

S00600004844521B
S1130000285F245F2212226A000424290008237C2A
S11300100002000800082629001853812341001813
S113002041E900084E42234300182342000824A952
S107003000144ED492
S9030000FC
  
```

The above module consists of an S0 header record, four S1 code/data records, and an S9 termination record.

The S0 header record is comprised of the following character pairs:

S0	S-record type S0, indicating a header record.
06	Hexadecimal 06 (decimal 6), indicating six character pairs (or ASCII bytes) follow.
00 00	Four-character 2-byte address field, zeroes.
48 44 52	ASCII H, D, and R – "HDR".
1B	Checksum of S0 record.

The first S1 code/data record is explained as follows:

S1	S-record type S1, indicating a code/data record to be loaded/verified at a 2-byte address.
13	Hexadecimal 13 (decimal 19), indicating 19 character pairs, representing 19 bytes of binary data, follow.
00 00	Four-character 2-byte address field; hexadecimal address 0000, indicates location where the following data is to be loaded.

