

TCM8000 CELLULAR TELEPHONE AUDIO PROCESSOR

SC1041A - D4086, AUGUST 1992 - REVISED APRIL 1993

functional block diagram

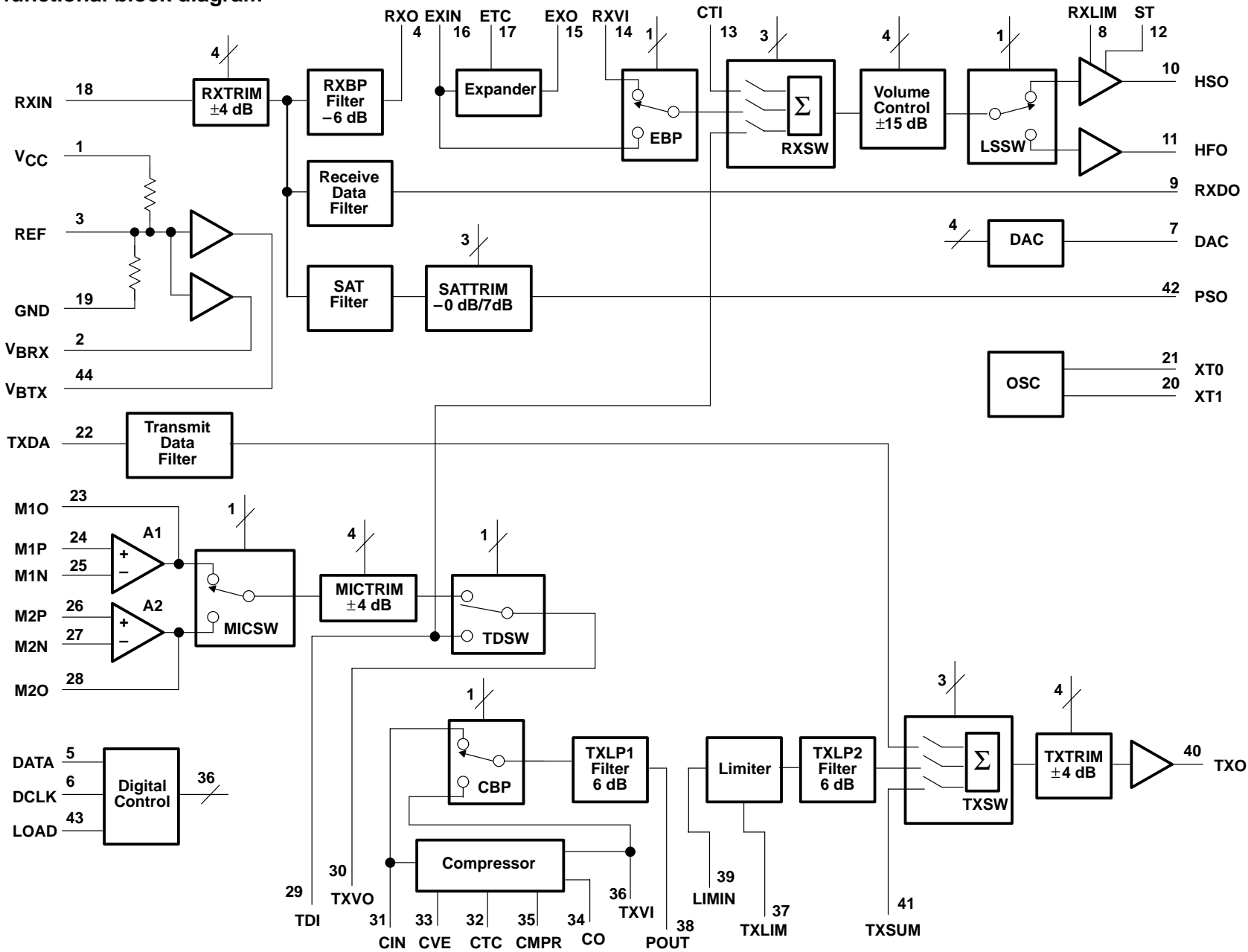

Pin numbers shown are for the FN package.

TCM8000 CELLULAR TELEPHONE AUDIO PROCESSOR

SCTS041A – D4086, AUGUST 1992 – REVISED APRIL 1993

Terminal Functions

NAME	PIN		I/O	DESCRIPTION
	NO.			
	FN	FR		
CIN	31	36	I	Compressor analog input
CMPR	35	40	I	Compressor rectifier analog input
CO	34	39	O	Compressor analog output. CO should be ac coupled to TXVI and to CMPR.
CTC	32	27	O	Compressor time constant control, analog output. A 220-nF capacitor should be connected between CTC and GND.
CTI	13	18	I	Call tone analog input. Signals on CTI are summed into the receive voice path prior to the volume control circuit. CTI can be muted under control of the serial interface.
CVE	33	38	I	Compressor virtual earth, analog input
DAC	7	12	O	Digital-to-analog converter output, programmable between GND and $V_{CC}/2$ in sixteen steps
DATA	5	10	I	Serial interface digital data input
DCLK	6	11	I	Serial interface digital clock input
ETC	17	22	O	Expander time constant control, analog output. A 220-nF capacitor should be connected between ETC and GND.
EXIN	16	21	I	Expander analog input
EXO	15	20	O	Expander analog output. EXO should be ac coupled to RXVI.
GND	19	24		Ground
HFO	11	16	O	Normal drive receiver voice analog output
HSO	10	15	O	High drive receiver voice analog output
LIMIN	39	44	I	Transmit limiter analog input
LOAD	43	4	I	Serial interface load, digital input. Data shifted into DATA under control of DCLK is transferred to internal registers when LOAD goes high.
M1N	25	30	I	Preamplifier 1 negative analog input
M1O	23	28	O	Preamplifier 1 analog output
M1P	24	29	I	Preamplifier 1 positive analog input
M2N	27	32	I	Preamplifier 2 negative analog input
M2O	28	33	O	Preamplifier 2 analog output
M2P	26	31	I	Preamplifier 2 positive analog input
POUT	38	43	O	Preemphasis filter analog output. POUT should be ac coupled to LIMIN.
PSO	42	3	O	Analog output of SAT filter
REF	3	8		Unbuffered midsupply voltage, nominal output $V_{CC}/2$
RXDO	9	14	O	Receive data filter analog output
RXIN	18	23	I	Receive analog input
RXLIM	8	13	I/O	Receive limiter adjust voltage, controls maximum signal output on HSO. The dc input is between GND and $V_{CC}/2$.
RXO	4	9	O	Receive voice filter analog output
RXVI	14	19	I	Receive voice analog input to volume control circuit. RXVI can be muted under control of the serial interface.
ST	12	17	I	Side tone analog input. Signals on this terminal are summed into the HSO output signal.
TDI	29	34	I	Tone of DTMF analog input. Signals on this terminal can be used in place of the main voice signal in the TX path and summed into the RX voice path, under control of the serial interface.
TXDA	22	27	I	Transmit data analog input
TXLIM	37	42	I	Transmit-limiter level adjust, controls maximum signal level at TXO. The dc input is between GND and $V_{CC}/2$.
TXO	40	1	O	Transmit section analog output
TXSUM	41	2	I	Transmit summing analog input. The signal on TXSUM is summed into the main TX output after all filter stages. TXSUM can be muted under control of the serial interface.
TXVI	36	41	I	Transmit voice analog input
TXVO	30	35	O	Transmit voice analog output. TXVO is the output from the preamplifier and microphone gain adjust sections. It should be ac coupled into the compressor input CIN.
VBRX	2	7		Buffered midsupply voltage to receive sections, nominal output $V_{CC}/2$

TCM8000 CELLULAR TELEPHONE AUDIO PROCESSOR

SCTS041A – D4086, AUGUST 1992 – REVISED APRIL 1993

Terminal Functions (continued)

PIN		I/O	DESCRIPTION
NAME	NO.		
	FN	FR	
V _{BTX}	44	5	Buffered midsupply for all transmit sections, nominal output $V_{CC}/2$
V _{CC}	1	6	Most positive supply voltage, $5\text{ V} \pm 5\%$
XT0, XT1	21, 20	26, 25	Crystal oscillator terminals for connection to 3.58-MHz crystal resonator

detailed description – transmit path

input conditioning

A pair of uncommitted operational amplifiers is provided at the main audio signal input. These components can be configured using external resistors to adjust the gain as required to suit particular microphones and external preamplifiers. The TCM8000 has been designed to provide 100 mVrms at the outputs of the preamplifier at pins M1O and M2O. The switch MICSW allows the selection of either amplifier input for hands-free or handset microphones. A digitally controlled gain/attenuation block, MICTRIM, allows adjustment of the signal level into the compressor in sixteen 0.5-dB steps. A digitally controlled switch, TDSW, allows alternative signals from other sources such as audio or DTMF tones to be injected into the transmit signal path from TDI. The output of TDSW is ac coupled at TXVO through an external capacitor into the compressor.

compressor

The compressor provides a 2:1 dynamic range compression of its input signal, converting an input range of 60 dB to 30 dB at its output. The test circuit diagram (Figure 2) shows the external components required to set time constants and to limit gain under idle channel conditions. The envelope time constant is determined by the value of a capacitor attached to CTC with 220 nF providing attack time of 3 ms approximately and decay times of approximately 13 ms. The compressor can be bypassed under control of the serial interface. The output from this stage, CO, is externally ac coupled into the transmit filter at TXVI and into the compressor rectifier input at CMPR.

TX filtering and limiter

The transmit band limiter is located between a pair of band-pass filters. Filter TXF1 is located before the limiter and provides 6 dB per octave preemphasis; filter TXF2, located after the limiter, features a phase-equalized response to control overshoot. The frequency responses of TXF1 and TXF2 are switchable between 3 kHz and 3.4 kHz cut off to meet the requirements of AMPS/TACS and NMT systems, respectively. Frequency response templates and typical responses are shown in Figures 3 through 6.

The limiter is provided to meet maximum deviation specifications, and the limit level is controlled by the dc voltage applied to TXLIM. The output signal from POUT is ac coupled into the limiter input to eliminate asymmetrical limiting that could arise as a result of dc offsets.

output conditioning

The voice output signal from TXLP2 is passed to a three-input summing circuit, whose other inputs come from the TX data path and from TXSUM. Each input to the summing circuit can be enabled or muted under control of the serial bus. The overall deviation level is controlled by a digitally controlled gain/attenuation block that provides sixteen 0.5-dB steps of output level adjustment. The transmit supervisory audio tone (SAT) is applied to TXSUM. TXSUM can also be used as an input for transmit data, allowing implementation of alternative data filtering and conditioning to that implemented on the TCM8000.

transmit data

Transmit data, which is voice-band FSK coded for NMT and wide-band Manchester coded for AMPS and TACS (8K-baud TACS, 10K-baud AMPS), is applied to TXDA. The signal is filtered by the TX DATA filter, whose response can be switched from a band-pass to a low-pass configuration to meet the requirements of NMT and AMPS/TACS, respectively. Frequency templates and typical responses are shown in Figures 7 and 8.



detailed description – receive path

input conditioning

The received demodulated signal is applied to RXIN and passes to a gain-adjust block that provides ± 4 dB of adjustment in sixteen 0.5-dB steps. At this point, the receive signal path is split into the voice path, the data path, and the supervisory audio-tone (SAT) path.

receive voice filter

The received voice signal is processed in the band-pass RXBP filter, whose response has been designed to meet the requirements of AMPS/TACS and NMT systems. The response incorporates the required 6-dB/octave de-emphasis. Frequency response templates and a typical response are shown in Figures 9 and 10.

expander

The expander implements a 2:1 dynamic range expansion of the signal at its input, EXIN. It is designed to produce 0-dB gain at 100 mVrms. Envelope attack and decay times are determined by a capacitor attached to ETC, with a value of 220 nF producing attack time of 3 ms and decay times of approximately 13 ms. The expander can be bypassed under control of the serial interface.

receive summing circuit and volume control

A 3-input summing circuit is provided, which takes as input the voice signal from the expander, audio tones from the TDI input, and a call-tone input applied to CTI. Each input can be enabled or muted under control of the serial interface. The output from this block is passed to the volume control, which provides ± 15 dB of output level control in sixteen 2-dB steps.

output buffers

Two output buffer circuits are provided. The buffer that drives HFO is capable of driving loads down to 10-k Ω impedance and is intended for use with an external speaker driver. The HSO buffer features a high-drive bipolar output stage that allows impedances of 500 Ω to be driven directly with low distortion. The HSO output path also incorporates a summing circuit to facilitate side-tone injection from the ST input and a limiter circuit, which allows maximum sound pressure levels to be determined. The limit level is controlled by the voltage applied to RXLIM. Selection between the HFO and HSO outputs is achieved via the serial interface.

receive data path

A switchable response filter is provided to condition receive data before it is output on RXDO. Frequency response templates and typical responses are shown in Figures 11 and 12 for AMPS/TACS and NMT, respectively.

receive SAT path

Received supervisory audio tones (SAT) are separated from the voice signal in a switchable response narrow-band filter. This filter has a center frequency of 6 kHz in the AMPS/TACS mode and 4 kHz in the NMT mode. The filter output is passed to a level-adjust circuit, which provides eight 1-dB steps of adjustment. The processed SAT signal is output on PSO.

miscellaneous

midsupply

The analog midsupply, effectively signal ground, is derived from a resistive divider connected between V_{CC} and GND to produce $V_{CC}/2$ at REF. This voltage is buffered by a pair of low output impedance amplifiers to produce midrail supplies for the receive and transmit sections at B_{BRX} and V_{BTX} , respectively, with separate midrails used to minimize coupling between the receive and transmit circuits. REF, V_{BTX} , and V_{BRX} should be decoupled to ground with capacitors physically mounted as close to the device as possible. V_{BTX} and V_{BRX} directly control the 0-dB point of the compressor and expander, respectively, so it is important that a stable and well-regulated supply is provided to V_{CC} .

TCM8000 CELLULAR TELEPHONE AUDIO PROCESSOR

SCTS041A – D4086, AUGUST 1992 – REVISED APRIL 1993

detailed description – miscellaneous

crystal oscillator

A low-power crystal oscillator is provided to generate the master clock signal for the switched-capacitor filters. Sampling frequencies and internal divide ratios have been selected to allow a low cost 3.58-MHz crystal to be used. No external components except the crystal are required.

DAC

A four-bit digital-to-analog (DAC) converter provides sixteen levels from GND to V_{BRX} in linear steps. The DAC can be used to set limit levels by controlling TXLIM or RXLIM. Its output is unbuffered and should only be used to drive high-impedance loads.

standby mode

The standby mode disables all signal paths with the exception of the receive data path. In the standby mode, current consumption is reduced to less than 4 mA.

digital interface

The TCM8000 is configured using a three-wire digital interface. Eight-bit words, comprised of four address and four data bits, are applied in serial to DATA and clocked into the device on the rising edge of DCLK. The data is transferred to internal registers by pulsing the LOAD signal high (see Figure 1). All internal registers are reset low on power up.

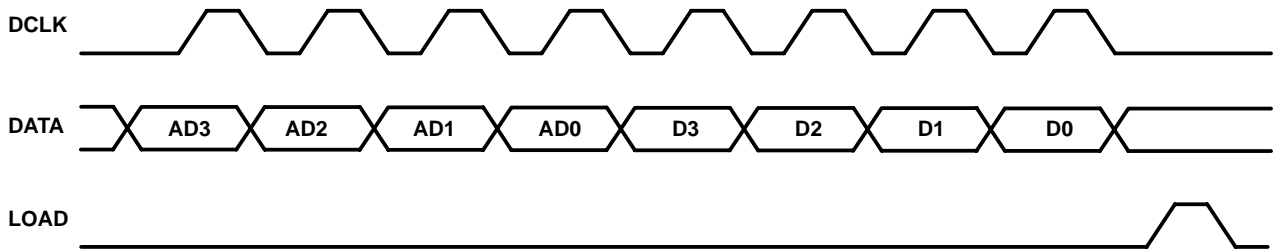

Figure 1. Serial Interface Timing Diagram

TCM8000 CELLULAR TELEPHONE AUDIO PROCESSOR

SCTS041A – D4086, AUGUST 1992 – REVISED APRIL 1993

Table 1. Register Definitions

AD ₃	AD ₂	AD ₁	AD ₀	D ₃	D ₂	D ₁	D ₀	FUNCTION
0	0	0	0	VC ₃	VC ₂	VC ₁	VC ₀	Volume control VC ₃ –VC ₀ set the output level on HFO and HSO in 2-dB steps from –16 dB <0000> to 14 dB <1111> relative to nominal, <1000>
0	0	0	1	TX ₃	TX ₂	TX ₁	TX ₀	TXTRIM gain adjust TX ₃ –TX ₀ set the main transmit output level in 0.5-dB steps from –4 dB <0000> to 3.5 dB <1111> relative to nominal, <1000>
0	0	1	0	SBY	RTM	RVM	CTM	SBY: Standby/active control, when set to 1, all sections of the device are active; when set to 0, all sections apart from from the receive data path are disabled. RTM: Receive DTMF/tone mute, 1 = mute, 0 = enabled RVM: Receive voice mute, 1 = mute, 0 = active CTM: Call tone mute, 1 = mute, 0 = active
0	0	1	1	HSS	TSM	TVM	TDM	HSS: Handset select, 1 selects HSO RX output and M1 preamplifier, 0 selects HFO output and M2 preamplifier TSM: TXSUM mute, 1 = mute, 0 = active TVM: Transmit voice mute, 1 = mute, 0 = active TDM: Transmit data-path mute, 1 = mute, 0 = active
0	1	0	0	–	NAT	TTS	CEN	NAT: NMT–AMPS/TACS select, 1 = NMT, 0 = AMPS/TACS TTS: Transmit DTMF/tone select, 1 = DTMF/tone, 0 = TX voice CEN: Compandor enable, 1 = compressor/expander enabled, 0 = bypassed (0-dB gain)
0	1	0	1	RX ₃	RX ₂	RX ₁	RX ₀	RXTRIM gain adjust RX ₃ –RX ₀ set the main transmit output level in 0.5-dB steps from –4 dB <0000> to 3.5 dB <1111> relative to nominal, <1000>
0	1	1	0	STM	ST ₂	ST ₁	ST ₀	SATTRIM gain adjust ST ₃ –ST ₀ set the receive SAT gain in 1-dB steps from –4 dB <000> to 3 dB <111> relative to nominal, <100>, STM: Receive SAT path mute, 1 = mute, 0 = active
0	1	1	1	MT ₃	MT ₂	MT ₁	MT ₀	MICTRIM gain adjust MT ₃ –MT ₀ set the microphone trim gain in 0.5-dB steps from –4 dB <0000> to 3.5 dB <1111> relative to nominal, <1000>
1	X	X	X	DA ₃	DA ₂	DA ₁	DA ₀	DAC control DA ₃ –DA ₀ set the level on the DAC output from 0 <0000> to V _{BRX} <1111>

TCM8000

CELLULAR TELEPHONE AUDIO PROCESSOR

SCTS041A – D4086, AUGUST 1992 – REVISED APRIL 1993

absolute maximum ratings over operating free-air temperature range (unless otherwise noted)†

Supply voltage range, V_{CC} (see Note 1)	–0.3 V to 7 V
Input voltage range, V_I	GND –0.3 V to $V_{CC} + 0.3$ V
Ground voltage range, GND	–0.3 V to 7 V
Operating free-air temperature range	–25°C to 80°C
Storage temperature range	–55°C to 100°C

† Stresses beyond those listed under “absolute maximum ratings” may cause permanent damage to the device. These are stress ratings only and functional operation of the device at these or any other conditions beyond those indicated under “recommended operating conditions” is not implied. Exposure to absolute-maximum-rated conditions for extended periods may affect device reliability.

NOTE 1: Voltage value is with respect to GND.

recommended operating conditions

	MIN	TYP	MAX	UNIT
V_{CC} Supply voltage	4.75	5	5.25	V
V_{IH} High-level input voltage	3.5			V
V_{IL} Low-level input voltage			0.8	V
T_A Operating free-air temperature	–25		80	°C

electrical characteristics over recommended operating temperature range, $V_{CC} = 5$ V, $f_{xtal} = 3.58$ MHz

PARAMETER		TEST CONDITIONS	MIN	MAX	UNIT
I_{CC} Supply current	Standby			4	mA
	Operating			14	
I_{IH} High-level input current		$V_I = 5$ V		10	μ A
I_{IL} Low-level input current		$V_I = 0$ V		10	μ A
f_{clock} Serial clock frequency, DCLK				200	kHz
Z_i Input impedance, RXIN, RXVI, CTI, ST, TXVI, LIMIN, TXSUM, CIN, TXDA, EXIN, CMPR, TDI		$f = 1$ kHz		70	k Ω
		$f = 1$ kHz		20	
	Midsupply reference voltage, REF		2.4	2.6	V
	Buffered midsupply reference voltage, V_{BTX} , V_{BRX}		2.4	2.6	V
	Input current at M1P, M1N, M2P, M2N, RXLIM, TXLIM			1	μ A

transmit path specifications, $V_{CC} = 5$ V, $f_{xtal} = 3.58$ MHz

M1/M2 to TXVO, MICTRIM, A1 and A2 configured as unity gain inverting amplifiers, input = 100 mVrms at 1 kHz at M1 or M2 (see Table 1)

PARAMETER	MIN	MAX	UNIT
Gain, MICTRIM = <1000>		± 1	dB
Step size	0.4	0.6	dB
Positive range	3	4	dB
Negative range	–4.5	–3.5	dB



TCM8000 CELLULAR TELEPHONE AUDIO PROCESSOR

SCTS041A – D4086, AUGUST 1992 – REVISED APRIL 1993

transmit path specifications, $V_{CC} = 5\text{ V}$, $f_{xtal} = 3.58\text{ MHz}$ (continued)

M1/M2 to TXO frequency response, NMT mode, TXLIM = 2.5 V, input = 20 mVrms, TXTRIM = <1000>, MICTRIM = <1000>, compressor bypassed (see Figures 3 and 4 and Table 1)

PARAMETER	TEST CONDITIONS	MIN	MAX	UNIT
Gain	f = 1 kHz	11.5	13.5	dB
Relative gain	f = 100 Hz		-19	dB
	f = 300 Hz	-13.1	-9.5	
	f = 500 Hz	-7	-5	
	f = 2 kHz	5	7	
	f = 3 kHz	7.7	10.5	
	f = 3.4 kHz	6.6	11.6	
	f = 3.94 kHz		-40	
	f = 4.06 kHz		-40	
	f = 10 kHz		-16.5	

M1/M2 to TXO frequency response, AMPS/TACS mode, TXLIM = 2.5 V, input = 20 mVrms, TXTRIM = <1000>, MICTRIM = <1000>, compressor bypassed (see Figures 5 and 6 and Table 1)

PARAMETER	TEST CONDITIONS	MIN	MAX	UNIT
Gain	f = 1 kHz	11.5	13.5	dB
Relative gain	f = 100 Hz		-19	dB
	f = 300 Hz	-13.1	-9.5	
	f = 500 Hz	-7	-5	
	f = 2 kHz	5	7	
	f = 2.75 kHz	6.8	9.8	
	f = 3 kHz	5.5	10.5	
	f = 3.1 kHz		10.8	
	f = 5.9 kHz		-25	
	f = 6.1 kHz		-25	
	f = 10 kHz		-19	

TXSUM to TXO gain adjust, input = 100 mVrms at 1 kHz (see Table 1)

PARAMETER	MIN	MAX	UNIT
Gain, TXTRIM = <1000>		±1	dB
Step size	0.4	0.6	dB
Positive range	3	4	dB
Negative range	-4.5	-3.5	dB

compressor gain characteristics, M1/M2 to TXO, f = 1 kHz, MICTRIM = <1000> (see Figure 2 for external components)

PARAMETER	TEST CONDITIONS	MIN	MAX	UNIT
Gain (reference)	M1/M2 = 100 mVrms	11	13	dB
Relative gain	M1/M2 = 100 mV + 3 dB	1	2	dB
	M1/M2 = 100 mV - 25 dB	-13	-12	
	M1/M2 = 100 mV - 50 dB	-25.5	-24.5	

TX limiter, peak-to-peak output at TXO relative to nominal output, M1/M2 = 1 Vrms at 1 kHz, MICTRIM = <1000>, compressor enabled, nominal output measured at TXO for 100 mVrms input at M1/M2

PARAMETER	TEST CONDITIONS	MIN	MAX	UNIT
Peak-to-peak output	TXLIM = 500 mV		1.25	V/V
	TXLIM = 550 mV		1.35	
	TXLIM = 600 mV		1.45	
	TXLIM = 650 mV		1.55	
	TXLIM = 800 mV		1.85	



TCM8000 CELLULAR TELEPHONE AUDIO PROCESSOR

SCTS041A – D4086, AUGUST 1992 – REVISED APRIL 1993

transmit path specifications, $V_{CC} = 5\text{ V}$, $f_{xtal} = 3.58\text{ MHz}$ (continued)

total harmonic distortion at TXO vs TXLIM, $M1/M2 = 100\text{ mVrms}$ at 1 kHz, MICTRIM = <1000>, TXTRIM = <1000>, compressor enabled

PARAMETER	TEST CONDITIONS	MIN	MAX	UNIT
Total harmonic distortion	TXLIM = 500 mV		10%	
	TXLIM = 550 mV		4%	
	TXLIM = 600 mV		1%	
	TXLIM = 800 mV		1%	

noise at TXO, $M1/M2 = V_{BTX}$, MICTRIM = <1000>, TXTRIM = <1000>, compressor enabled (see Table 1)

PARAMETER	MIN	MAX	UNIT
Psophometrically-weighted rms noise		4	mV

transmit path switch attenuation (see Table 1)

PARAMETER	TEST CONDITIONS	MIN	MAX	UNIT
Attenuation	MICSW, HSS = 0/1	50		dB
	TDSW, TTS = 0/1	50		
	TXVOICE, TVM = 1	50		
	TXSUM, TSM = 1	50		
	TXDATA, TDM = 1	50		

TDI to TXO gain, TDI = 100 mVrms at 1 kHz, TXTRIM = <1000> (see Table 1)

PARAMETER	MIN	MAX	UNIT
Gain	11	13	dB

transmit data frequency response, NMT mode, TXDA = 275 mVrms, TXTRIM = <1000> (see Figure 7 and Table 1)

PARAMETER	TEST CONDITIONS	MIN	MAX	UNIT
Gain	$f = 1.5\text{ kHz}$	2	4	dB
Relative gain	$f = 100\text{ Hz}$		-22	dB
	$f = 700\text{ Hz}$	-7.6	-5.6	
	$f = 2.1\text{ kHz}$	1.9	2.9	
	$f = 2.3\text{ kHz}$		4.7	
	$f = 3.5\text{ kHz}$		4.7	
	$f = 100\text{ kHz}$		-25	

transmit data frequency response, AMPS/TACS mode, TXDA = 400 mVrms, TXTRIM = <1000> (see Figure 8 and Table 1)

PARAMETER	TEST CONDITIONS	MIN	MAX	UNIT
Gain	$f = 1\text{ kHz}$		± 1	dB
Relative gain	$f = 8\text{ kHz}$		± 1	dB
	$f = 16\text{ kHz}$	-6	1	
	$f = 30\text{ kHz}$		-18	
	$f = 100\text{ kHz}$		-18	

digital-to-analog converter, measured at DAC (see Table 1 for codes)

PARAMETER	MIN	MAX	UNIT
Output code <0000>		50	mV
Output code <1111>, relative V_{BRX}	-100	0	mV
DNL, typical step size = 160 mV		0.5	LSB



TCM8000 CELLULAR TELEPHONE AUDIO PROCESSOR

SCTS041A – D4086, AUGUST 1992 – REVISED APRIL 1993

receive path specifications, $V_{CC} = 5\text{ V}$, $f_{xtal} = 3.58\text{ MHz}$

RXIN to RXO, RXTRIM, RXIN = 100 mVrms at 1 kHz (see Table 1)

PARAMETER	MIN	MAX	UNIT
Gain, RXTRIM = <1000>	-7	-5	dB
Step size	0.4	0.6	dB
Positive range	3	4	dB
Negative range	-4.5	-3.5	dB

RXIN to HFO/HSO frequency response, RXIN = 60 mVrms, RXTRIM = <1000>, VC = <1000>, expander bypassed (see Figures 9 and 10 and Table 1)

PARAMETER	TEST CONDITIONS	MIN	MAX	UNIT
Gain	f = 1 kHz	-7	-5	dB
Relative gain	f = 100 Hz		-30	dB
	f = 240 Hz		13.4	
	f = 300 Hz	7.9	11.5	
	f = 500 Hz	5	7	
	f = 2 kHz	-7	-5	
	f = 3 kHz	-12	-8.5	
	f = 3.4 kHz	-17	-9.6	
	f = 4 kHz		-40	
	f = 10 kHz		-40	

CTI to HFO/HSO, volume control, CTI = 100 mVrms at 1 kHz (see Table 1)

PARAMETER	MIN	MAX	UNIT
Gain, VC = <1000>	0	2	dB
Step size	1.8	2.2	dB
Positive range	13.5	14.5	dB
Negative range	-16.5	-15.5	dB

ST/TDI to HFO/HSO gain, ST/TDI = 100 mVrms at 1 kHz, VC = <1000> (see Table 1)

PARAMETER	MIN	MAX	UNIT
Gain ST to HSO	-7	-5	dB
Gain to TDI to HSO/HFO		±1	dB

expander gain characteristics, RXIN to HSO/HFO, f = 1 kHz, RXTRIM = <1000>, VC = <1000> (see Figure 2)

PARAMETER	TEST CONDITIONS	MIN	MAX	UNIT
Gain (reference)	RXIN = 200 mVrms		±1	dB
Expanded relative gain	RXIN = 200 mV + 3 dB	2	4	dB
	RXIN = 200 mV - 12.5 dB	-13.5	-11.5	
	RXIN = 200 mV - 25 dB	-23	-21	

RX limiter, peak-to-peak output at HSO vs RXLIM, RXIN = 500 mVrms at 1 kHz, RXTRIM = <1000>, VC = <1000>, expander enabled

PARAMETER	TEST CONDITIONS	MIN	MAX	UNIT
Peak-to-peak output	RXLIM = 750 mV		1.6	V _{pp}
	RXLIM = 850 mV		1.8	
	RXLIM = 950 mV		2	



TCM8000 CELLULAR TELEPHONE AUDIO PROCESSOR

SCTS041A – D4086, AUGUST 1992 – REVISED APRIL 1993

receive path specifications, $V_{CC} = 5\text{ V}$, $f_{xtal} = 3.58\text{ MHz}$ (continued)

noise and distortion at HFO/HSO, $RXTRIM = <1000>$, $VC = <1000>$, expander enabled (see Table 1)

PARAMETER	MIN	MAX	UNIT
Psophometrically-weighted rms noise, $RXIN = V_{BRX}$		1	mV
Total harmonic distortion, $RXIN = 200\text{ mV rms at } 1\text{ kHz}$		1%	

receive path switch attenuation (see Table 1)

PARAMETER	TEST CONDITIONS	MIN	MAX	UNIT
Attenuation	CTI, CTM = 1	50		dB
	TDI, RTM = 1	50		
	RXVOICE, RVM = 1	50		
	LSSW, HSS = 0/1	50		

receive data frequency response, NMT mode, $RXIN = 100\text{ mVrms}$, $RXTRIM = <1000>$ (see Figure 11 and Table 1)

PARAMETER	TEST CONDITIONS	MIN	MAX	UNIT
Gain	$f = 1.5\text{ kHz}$	8	10	dB
Relative gain	$f = 100\text{ Hz}$		-10	dB
	$f = 600\text{ Hz}$		5.4	
	$f = 800\text{ Hz}$	3.4	5.4	
	$f = 900\text{ Hz}$	3.4	5.4	
	$f = 2.2\text{ kHz}$	-4.3	-2.3	
	$f = 10\text{ kHz}$		-15.5	

receive data frequency response, AMPS/TACS mode, $RXIN = 100\text{ mVrms}$, $RXTRIM = <1000>$ (see Figure 12 and Table 1)

PARAMETER	TEST CONDITIONS	MIN	MAX	UNIT
Gain	$f = 1\text{ kHz}$	5	7	dB
Relative gain	$f = 8\text{ kHz}$		± 1	dB
	$f = 16\text{ kHz}$	-6	1	
	$f = 40\text{ kHz}$		-18	
	$f = 100\text{ kHz}$		-18	

receive SAT path frequency response, NMT mode, $RXIN = 100\text{ mVrms}$, $RXTRIM = <1000>$, $SATTRIM = <100>$ (see Figure 13 and Table 1)

PARAMETER	TEST CONDITIONS	MIN	MAX	UNIT
Gain	$f = 4\text{ kHz}$	3	5	dB
Relative gain	$f = 100\text{ Hz}$		-35	dB
	$f = 2\text{ kHz}$		-35	
	$f = 3.2\text{ kHz}$		-25	
	$f = 3.4\text{ kHz}$		-20	
	$f = 3.8\text{ kHz}$	-5	0.5	
	$f = 3.94\text{ kHz}$		± 0.5	
	$f = 4.06\text{ kHz}$		± 0.5	
	$f = 4.2\text{ kHz}$	-5	0.5	
	$f = 5\text{ kHz}$		-20	
	$f = 6\text{ kHz}$		-35	
	$f = 10\text{ kHz}$		-35	

TCM8000 CELLULAR TELEPHONE AUDIO PROCESSOR

SCTS041A – D4086, AUGUST 1992 – REVISED APRIL 1993

receive path specifications, $V_{CC} = 5\text{ V}$, $f_{xtal} = 3.58\text{ MHz}$ (continued)

receive SAT path frequency response, AMPS/TACS mode, $RXIN = 100\text{ mVrms}$, $RXTRIM = <1000>$, $SATTRIM = <100>$ (see Figure 15 and Table 1)

PARAMETER	TEST CONDITIONS	MIN	MAX	UNIT
Gain	$f = 6\text{ kHz}$	3	5	dB
Relative gain	$f = 100\text{ Hz}$		-35	dB
	$f = 3\text{ kHz}$		-35	
	$f = 4.8\text{ kHz}$		-25	
	$f = 5.1\text{ kHz}$		-20	
	$f = 5.8\text{ kHz}$	-5	0.5	
	$f = 5.94\text{ kHz}$		± 0.5	
	$f = 6.06\text{ kHz}$		± 0.5	
	$f = 6.2\text{ kHz}$	-5	0.5	
	$f = 7.5\text{ kHz}$		-20	
	$f = 9\text{ kHz}$		-35	
	$f = 10\text{ kHz}$		-35	

receive SAT path trim, $SATTRIM$, $RXIN = 100\text{ mVrms}$, f at 4 kHz NMT, f at 6 kHz AMPS/TACS, $RXTRIM = <1000>$ (see Table 1)

PARAMETER	MIN	MAX	UNIT
Gain, $SATTRIM = <100>$	3	5	dB
Step size	0.8	1.2	dB
Positive range	2.5	3.5	dB
Negative range	-4.5	-3.5	dB

TCM8000
CELLULAR TELEPHONE AUDIO PROCESSOR

SCT5041A - D4086, AUGUST 1992 - REVISED APRIL 1993

PARAMETER MEASUREMENT INFORMATION

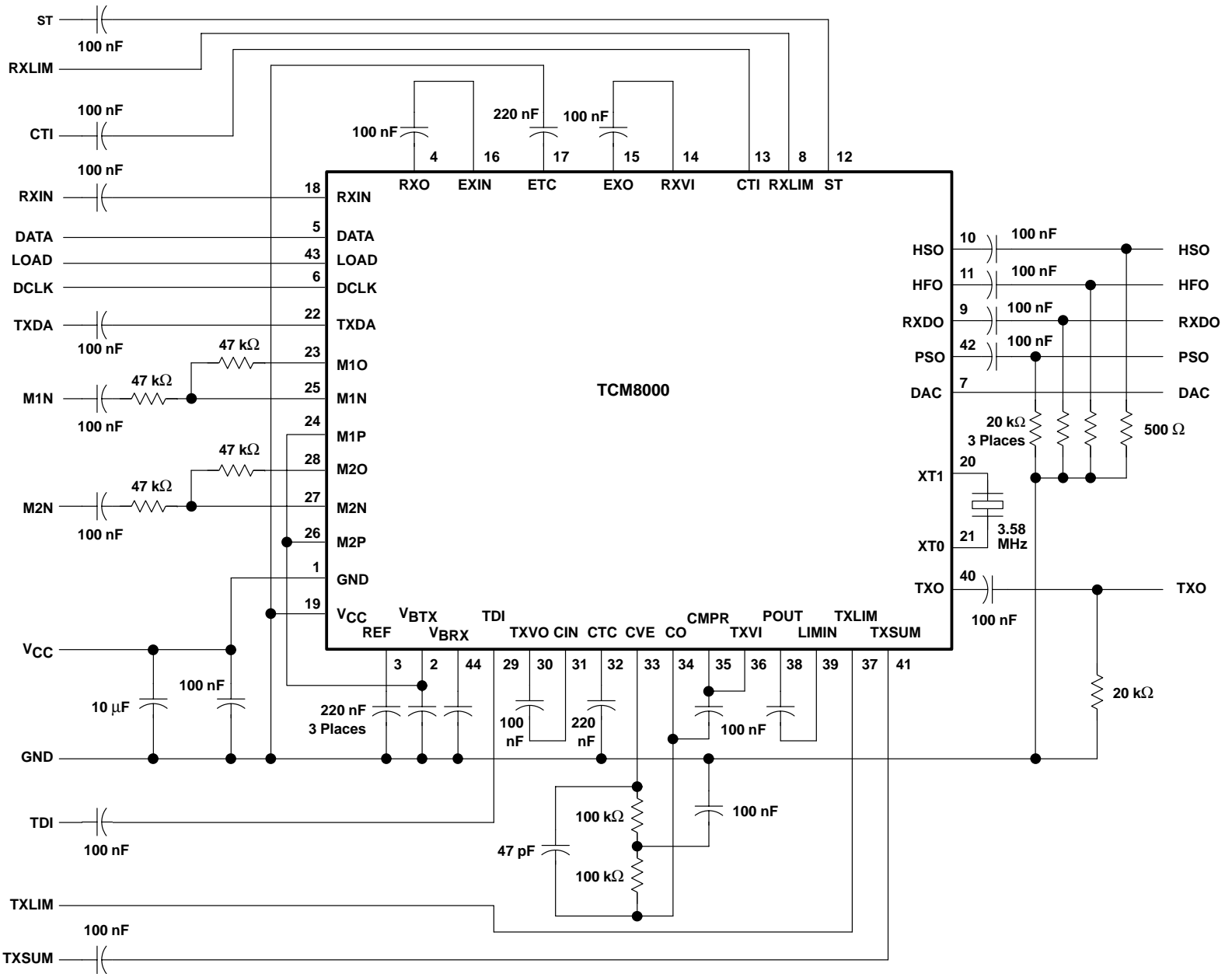

Pin numbers shown are for the FN package only.

Figure 2. Test Circuit

TYPICAL CHARACTERISTICS†

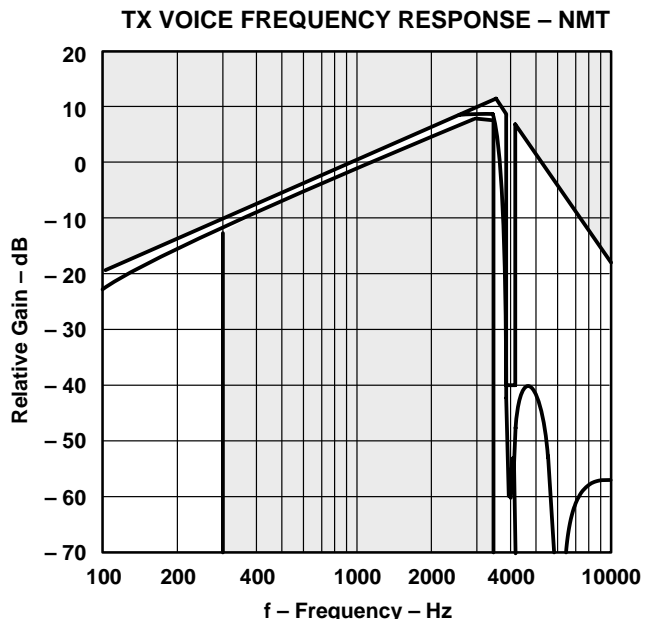

Figure 3

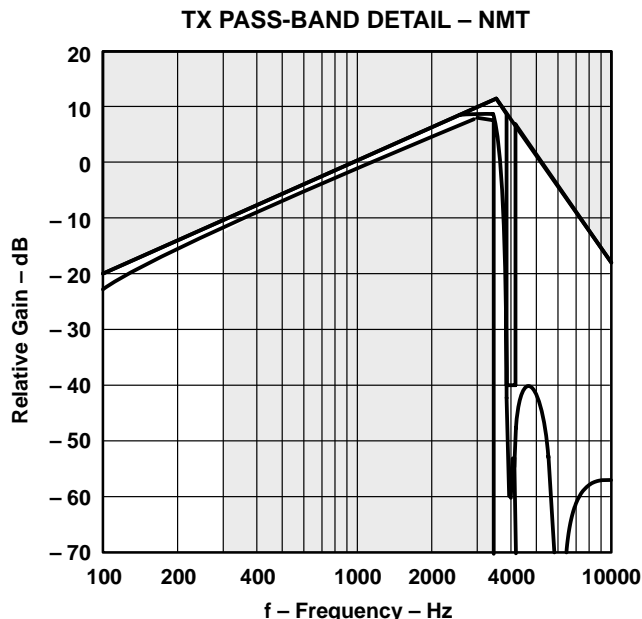

Figure 4

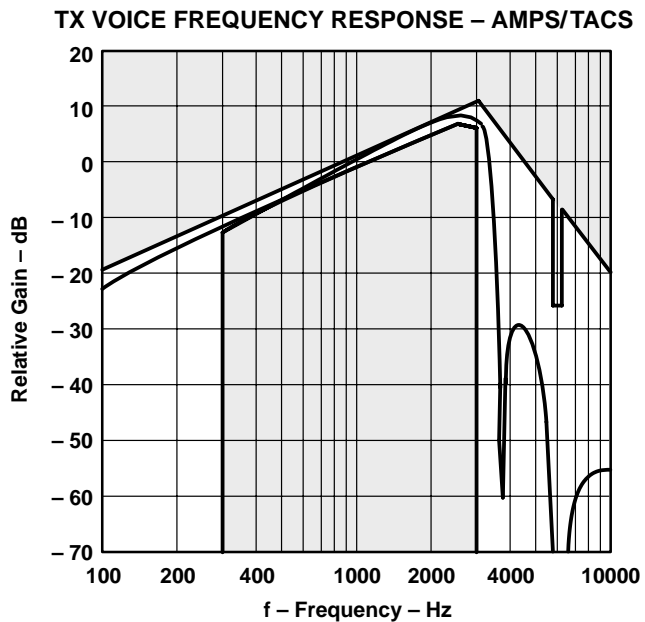

Figure 5

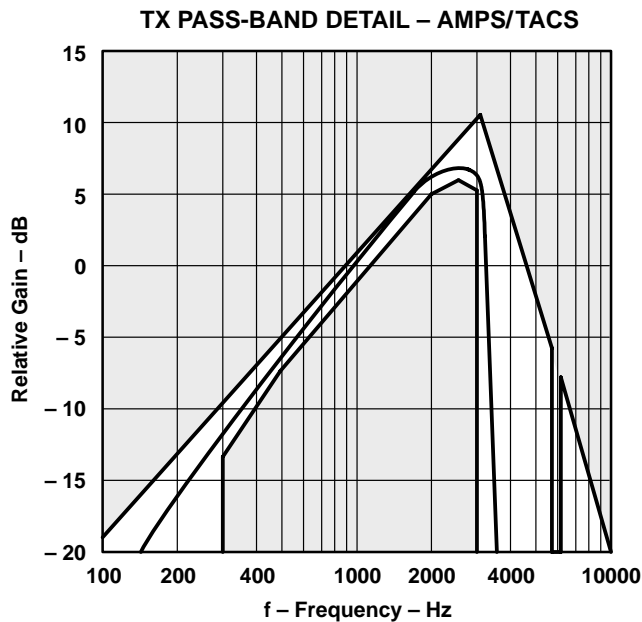

Figure 6

† The boundaries of the shaded areas represent the frequency response limits met by the TCM8000. The curves in the unshaded areas represent typical filter response of the device.

TCM8000 CELLULAR TELEPHONE AUDIO PROCESSOR

SCTS041A – D4086, AUGUST 1992 – REVISED APRIL 1993

TYPICAL CHARACTERISTICS†

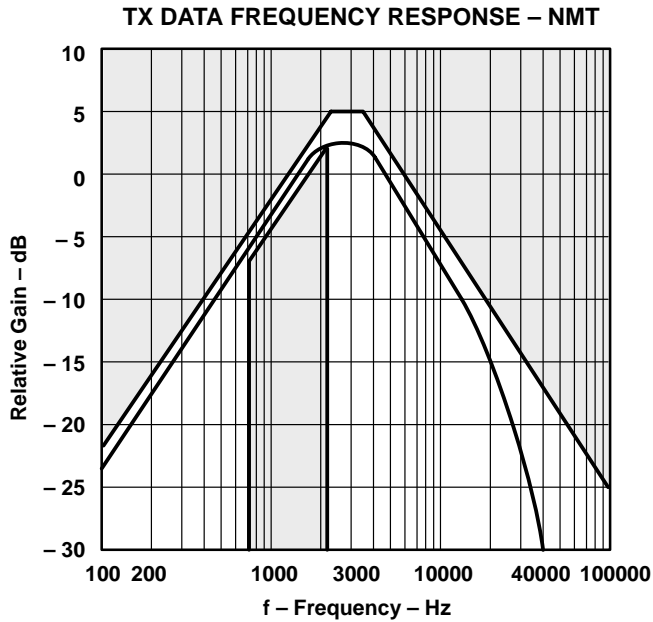

Figure 7

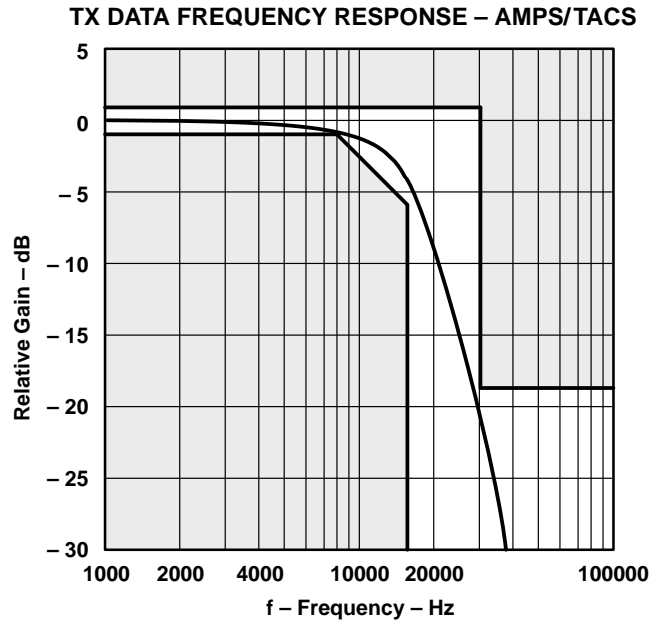

Figure 8

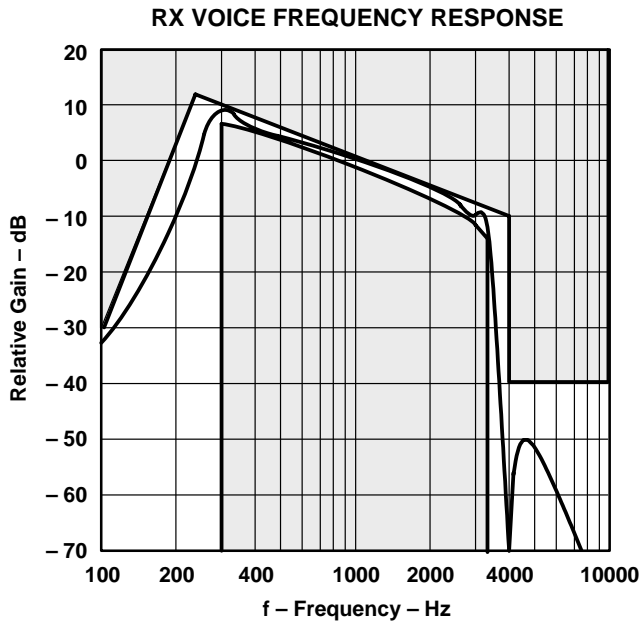

Figure 9

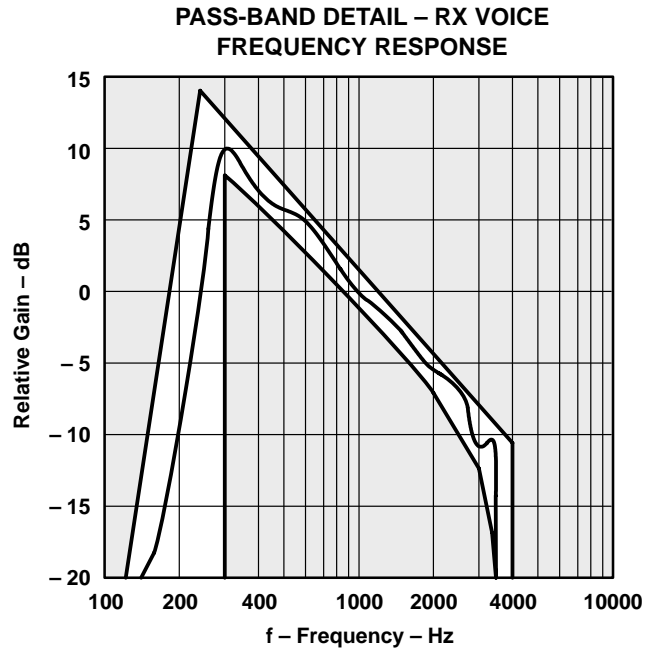

Figure 10

† The boundaries of the shaded areas represent the frequency response limits met by the TCM8000. The curves in the unshaded areas represent the filter response of the device.

TYPICAL CHARACTERISTICS†

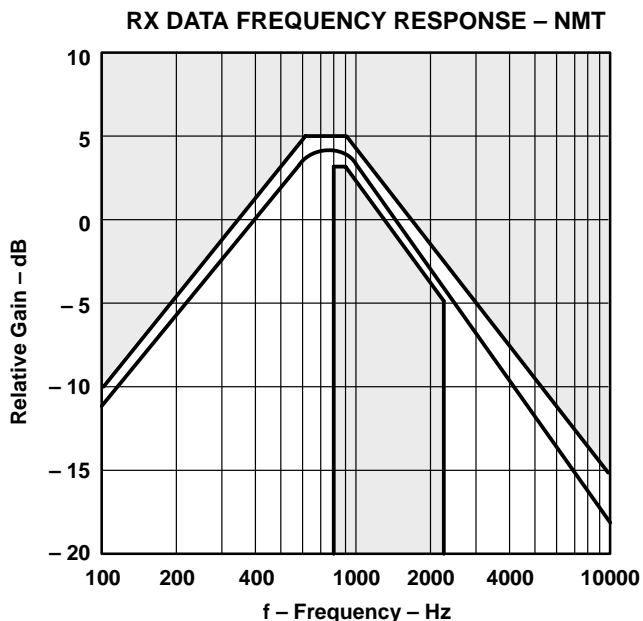

Figure 11

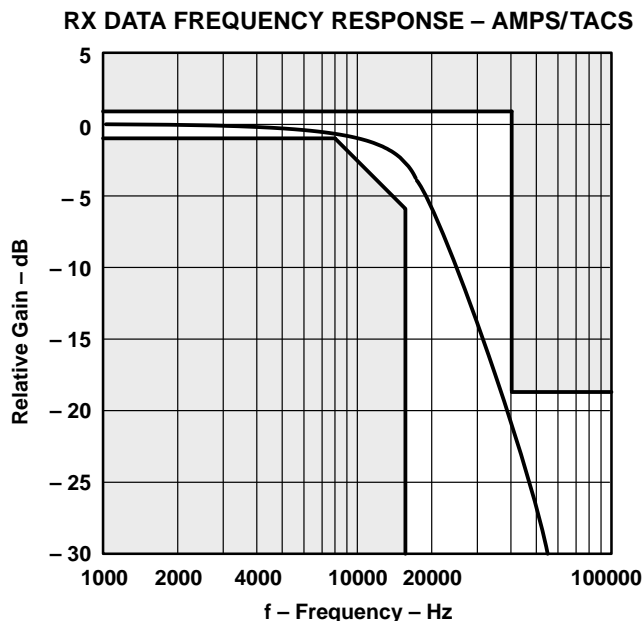

Figure 12

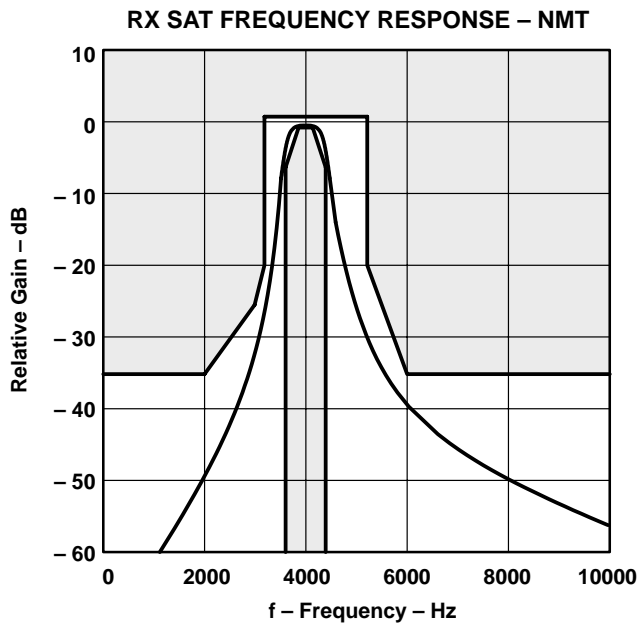

Figure 13

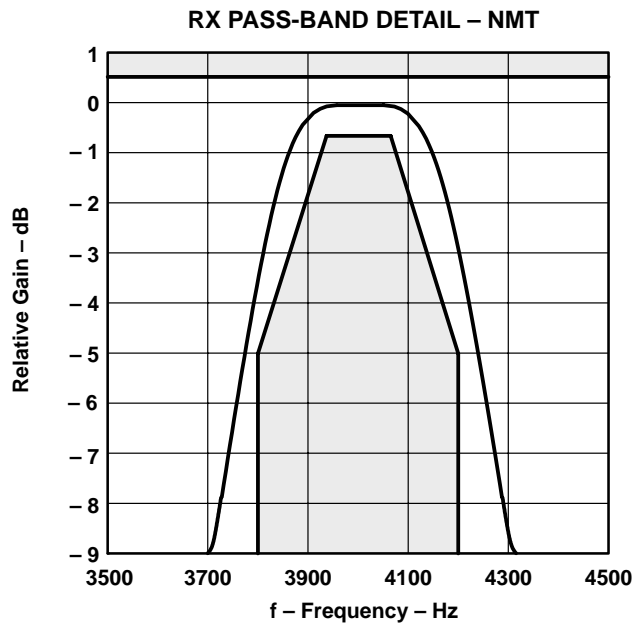

Figure 14

† The boundaries of the shaded areas represent the frequency response limits met by the TCM8000. The curves in the unshaded areas represent the filter response of the device.

TCM8000 CELLULAR TELEPHONE AUDIO PROCESSOR

SCTS041A – D4086, AUGUST 1992 – REVISED APRIL 1993

TYPICAL CHARACTERISTICS†

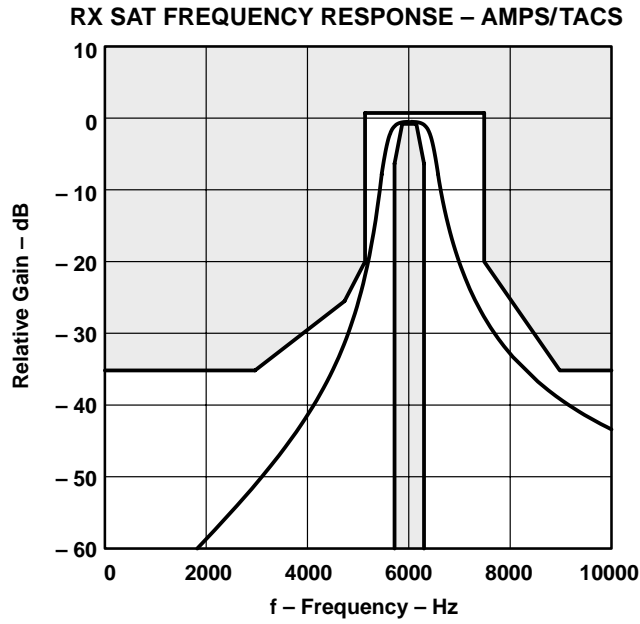

Figure 15

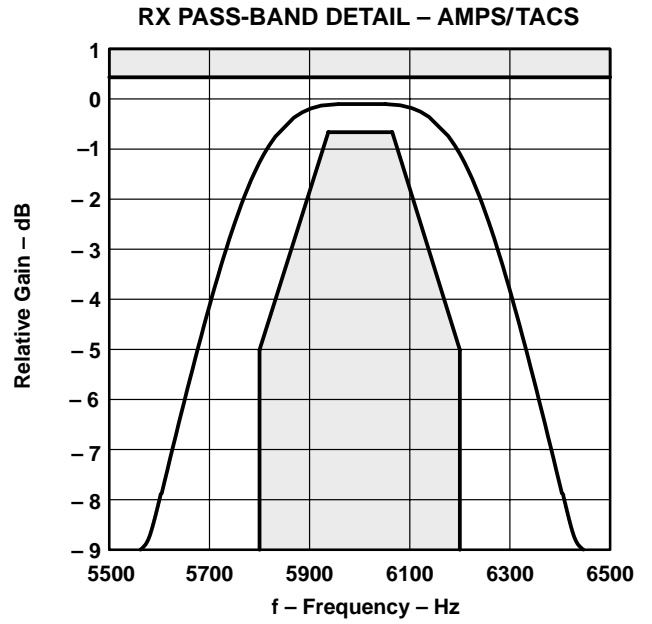

Figure 16

† The boundaries of the shaded areas represent the frequency response limits met by the TCM8000. The curves in the unshaded areas represent the filter response of the device.

IMPORTANT NOTICE

Texas Instruments (TI) reserves the right to make changes to its products or to discontinue any semiconductor product or service without notice, and advises its customers to obtain the latest version of relevant information to verify, before placing orders, that the information being relied on is current.

TI warrants performance of its semiconductor products and related software to the specifications applicable at the time of sale in accordance with TI's standard warranty. Testing and other quality control techniques are utilized to the extent TI deems necessary to support this warranty. Specific testing of all parameters of each device is not necessarily performed, except those mandated by government requirements.

Certain applications using semiconductor products may involve potential risks of death, personal injury, or severe property or environmental damage ("Critical Applications").

TI SEMICONDUCTOR PRODUCTS ARE NOT DESIGNED, INTENDED, AUTHORIZED, OR WARRANTED TO BE SUITABLE FOR USE IN LIFE-SUPPORT APPLICATIONS, DEVICES OR SYSTEMS OR OTHER CRITICAL APPLICATIONS.

Inclusion of TI products in such applications is understood to be fully at the risk of the customer. Use of TI products in such applications requires the written approval of an appropriate TI officer. Questions concerning potential risk applications should be directed to TI through a local SC sales office.

In order to minimize risks associated with the customer's applications, adequate design and operating safeguards should be provided by the customer to minimize inherent or procedural hazards.

TI assumes no liability for applications assistance, customer product design, software performance, or infringement of patents or services described herein. Nor does TI warrant or represent that any license, either express or implied, is granted under any patent right, copyright, mask work right, or other intellectual property right of TI covering or relating to any combination, machine, or process in which such semiconductor products or services might be or are used.