

# TL601, TL604, TL607, TL610 P-MOS ANALOG SWITCHES

SLAS042 – D2161, JUNE 1976 — REVISED OCTOBER 1986

- Switch  $\pm 10$ -V Analog Signals
- TTL Logic Capability
- 5-to 30-V Supply Ranges
- Low ( $100 \Omega$ ) On-State Resistance
- High ( $10^{11} \Omega$ ) Off-State Resistance
- 8-Pin Functions

## description

The TL601, TL604, TL607, and TL610 are a family of monolithic P-MOS analog switches that provide fast switching speeds with high  $r_{off}/r_{on}$  ratio and no offset voltage. The p-channel enhancement-type MOS switches accept analog signals up to  $\pm 10$  V and are controlled by TTL-compatible logic inputs. The monolithic structure is made possible by BI-MOS technology, which combines p-channel MOS with standard bipolar transistors.

These switches are particularly useful in military, industrial, and commercial applications such as data acquisition, multiplexers, A/D and D/A converters, MODEMS, sample-and-hold systems, signal multiplexing, integrators, programmable operational amplifiers, programmable voltage regulators, crosspoint switching networks, logic interface, and many other analog systems.

The TL601 is an SPDT switch with two logic control inputs. The TL604 is a dual complementary SPST switch with a single control input. The TL607 is an SPDT switch with one logic control input and one enable input. The TL610 is an SPST switch with three logic control inputs. The TL610 features a higher  $r_{off}/r_{on}$  ratio than the other members of the family.

The TL601C, TL604C, TL607C, and TL610C are characterized for operation from  $0^\circ\text{C}$  to  $70^\circ\text{C}$ , the TL601I, TL604I, TL607I, and TL610I are characterized for operation from  $-25^\circ\text{C}$  to  $85^\circ\text{C}$ , and the TL601M, TL604M, TL607M, and TL610M are characterized for operation over the full military temperature range of  $-55^\circ\text{C}$  to  $125^\circ\text{C}$ .

### JG OR P PACKAGE (TOP VIEW)

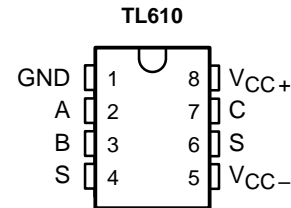
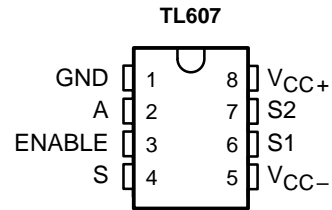
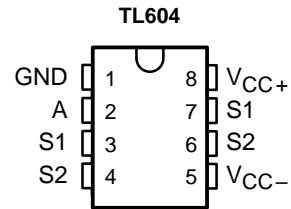
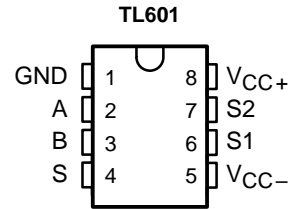

## schematics of inputs and outputs

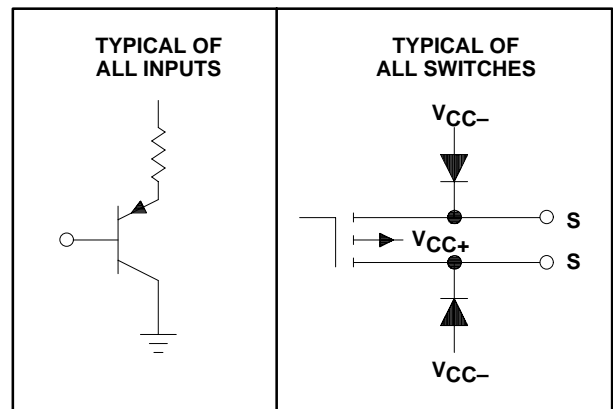

PRODUCTION DATA information is current as of publication date. Products conform to specifications per the terms of Texas Instruments standard warranty. Production processing does not necessarily include testing of all parameters.

TEXAS  
INSTRUMENTS

POST OFFICE BOX 655303 • DALLAS, TEXAS 75265

Copyright © 1986, Texas Instruments Incorporated

# TL601, TL604, TL607, TL610 P-MOS ANALOG SWITCHES

D2161, JUNE 1976 — REVISED OCTOBER 1986

## logic symbols† and switch diagrams

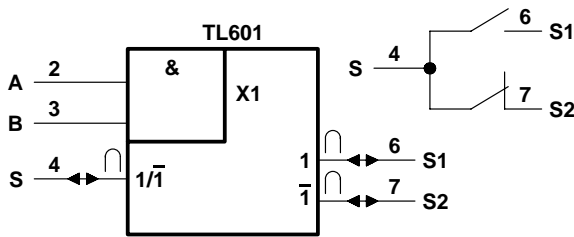

FUNCTION TABLE

INPUTS		ANALOG SWITCHES	
A	B	S1	S2
L	X	Off (open)	On (closed)
X	L	Off (open)	On (closed)
H	H	On (closed)	Off (open)

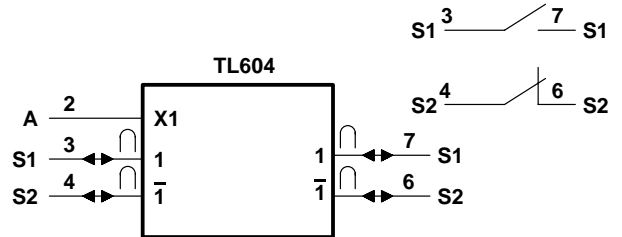

FUNCTION TABLE

INPUT	ANALOG SWITCHES	
A	S1	S2
H	On (closed)	Off (open)
L	Off (open)	On (closed)

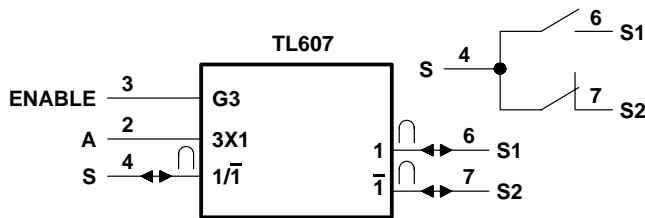

FUNCTION TABLE

INPUTS		ANALOG SWITCHES	
A	ENABLE	S1	S2
X	L	Off (open)	Off (open)
L	H	Off (open)	On (closed)
H	H	On (closed)	Off (open)

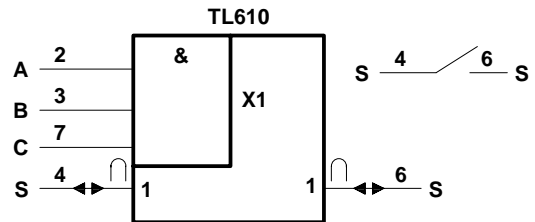

FUNCTION TABLE

INPUTS			ANALOG SWITCHES
A	B	C	S
L	X	X	Off (open)
X	L	X	Off (open)
X	X	L	Off (open)
X	H	H	On (closed)

† These symbols are in accordance with ANSI/IEEE Std 91-1984.

## TL607 logic diagram (positive logic)

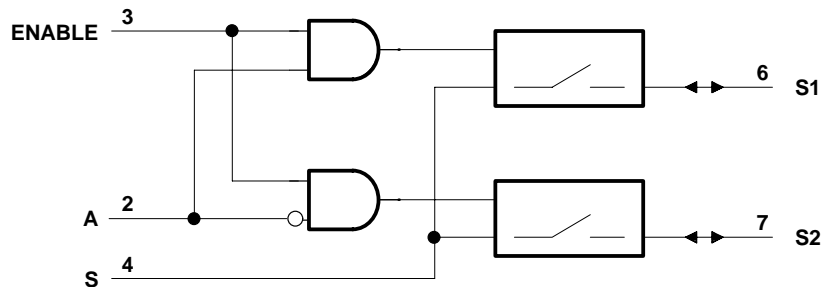

# TL601, TL604, TL607, TL610 P-MOS ANALOG SWITCHES

D2161, JUNE 1976 — REVISED OCTOBER 1986

## absolute maximum ratings over operating free-air temperature range (unless otherwise noted)

Supply voltage, $V_{CC+}$ (see Note 1)	30 V
Supply voltage, $V_{CC-}$	-30 V
$V_{CC+}$ to $V_{CC-}$ supply voltage differential	35 V
Control input voltage	$V_{CC+}$
Switch off-state voltage	30 V
Switch on-state current	10 mA
Operating free-air temperature range:	
TL601C, TL604C, TL607C, TL610C	0°C to 70°C
TL601I, TL604I, TL607I, TL610I	-25°C to 85°C
TL601M, TL604M, TL607M, TL610M	-55°C to 125°C
Storage temperature range	-65°C to 150°C
Lead temperature (1,6 mm) 1/16 inch from case for 60 seconds: JG package	300°C
Lead temperature (1,6 mm) 1/16 inch from case for 10 seconds: P package	260°C

NOTE 1: All voltage values are with respect to network ground terminal.

## recommended operating conditions

	TL601C, TL604C TL607C, TL610C			TL601I, TL604I TL607I, TL610I			TL601M, TL604M TL607M, TL610M			UNIT
	MIN	TYP	MAX	MIN	TYP	MAX	MIN	TYP	MAX	
Supply voltage, $V_{CC+}$ (see Figure 1)	5	10	25	5	10	25	5	10	25	V
Supply voltage, $V_{CC-}$ (see Figure 1)	-5	-20	-25	-5	-20	-25	-5	-20	-25	V
$V_{CC+}$ to $V_{CC-}$ supply voltage differential (see Figure 1)	15		30	15		30	15		30	V
High-level control input voltage, $V_{IH}$	2		5.5	2		5.5	2		5.5	V
Low-level control input voltage, $V_{IL}$	All inputs			0.8			0.8			
Voltage at any analog switch (S) terminal	$V_{CC-} + 8$		$V_{CC+}$	$V_{CC-} + 8$		$V_{CC+}$	$V_{CC-} + 8$		$V_{CC+}$	V
Switch on-state current	10			10			10			mA
Operating free-air temperature, $T_A$	0		70	25		85	-55		125	°C

# TL601, TL604, TL607, TL610 P-MOS ANALOG SWITCHES

D2161, JUNE 1976 — REVISED OCTOBER 1986

electrical characteristics over recommended operating free-air temperature range,  $V_{CC+} = 10\text{ V}$ ,  $V_{CC-} = -20\text{ V}$ , analog switch test current = 1 mA (unless otherwise noted)

PARAMETER	TEST CONDITIONS†	TL6 __ C			TL6 __ M TL6 __ I			UNIT	
		MIN	TYP‡	MAX	MIN	TYP‡	MAX		
$I_{IH}$ High-level input current	$V_I = 5.5\text{ V}$		0.5	10		0.5	10	$\mu\text{A}$	
$I_{IL}$ Low-level input current	$V_I = 0.4\text{ V}$		-50	-250		-50	-250	$\mu\text{A}$	
$I_{off}$ Switch off-state current	$V_{I(sw)} = -10\text{ V}$ , See Note 2	$T_A = 25^\circ\text{C}$		-500		-400		$\rho\text{A}$	
		$T_A = \text{MAX}^\dagger$		-10	-20		-50	-100	$\text{nA}$
$r_{on}$ Switch on-state resistance	$V_{I(sw)} = 10\text{ V}$ , $I_{O(sw)} = -1\text{ mA}$	TL601 TL604 TL607		75	200		55	100	$\Omega$
		TL610		40	100		40	80	
	$V_{I(sw)} = -10\text{ V}$ , $I_{O(sw)} = -1\text{ mA}$	TL601 TL604 TL607		220	600		220	400	
		TL610		120	300		120	300	
$r_{off}$ Switch off-state resistance			20		20		$\text{G}\Omega$		
$C_{on}$ Switch on-state input capacitance	$V_{I(sw)} = 0\text{ V}$ , $f = 1\text{ MHz}$		16		16		$\text{pF}$		
$C_{off}$ Switch off-state input capacitance	$V_{I(sw)} = 0\text{ V}$ , $f = 1\text{ MHz}$		8		8		$\text{pF}$		
$I_{CC+}$ Supply current from $V_{CC+}$	Logic input(s) at 5.5 V, All switch terminals open		TL601 TL604	5	10		5	10	$\text{mA}$
		ENABLE high		5	10		5	10	
		ENABLE low	TL607	3	5		3	5	
			TL610	5	10		5	10	
$I_{CC-}$ Supply current from $V_{CC-}$	Logic input(s) at 5.5 V, All switch terminals open		TL601 TL604	-1.2	-2.5		-1.2	-2.5	$\text{mA}$
		ENABLE high		-2.5	-5		-2.5	-5	
		ENABLE low	TL607	-0.05	-0.5		-0.05	-0.5	
			TL610	-1.2	-2.5		-1.2	-2.5	

† MAX is  $70^\circ\text{C}$  for C-suffix types,  $85^\circ\text{C}$  for I-suffix types, and  $125^\circ\text{C}$  for M-suffix types.

‡ All typical values are at  $T_A = 25^\circ\text{C}$  except for  $I_{off}$  at  $T_A = \text{MAX}$ .

NOTE 2: The other terminal of the switch under test is at  $V_{CC+} = 10\text{ V}$ .

switching characteristics,  $V_{CC+} = 10\text{ V}$ ,  $V_{CC-} = -20\text{ V}$ ,  $T_A = 25^\circ\text{C}$

PARAMETER	TEST CONDITIONS	MIN	TYP	MAX	UNIT
$t_{off}$ Switch turn-off time	$R_L = 1\text{ k}\Omega$ , $C_L = 35\text{ pF}$ , See Figure 2		400	500	$\text{ns}$
$t_{on}$ Switch turn-on time			100	150	



**PARAMETER MEASUREMENT INFORMATION**

Figure 1 shows power supply boundary conditions for proper operation of the TL601 Series. The range of operation for supply  $V_{CC+}$  from 5 V to 25 V is shown on the vertical axis. The range of  $V_{CC-}$  from -5 V to -25 V is shown on the horizontal axis. A recommended 30-V maximum voltage differential from  $V_{CC+}$  to  $V_{CC-}$  governs the maximum  $V_{CC+}$  for a chosen  $V_{CC-}$  (or vice versa). A minimum recommended difference of 15 V from  $V_{CC+}$  to  $V_{CC-}$  and the boundaries shown in Figure 1 allow the designer to select the proper combinations of the two supplies.

The designer-selected  $V_{CC+}$  supply value for a chosen  $V_{CC-}$  supply value limits the maximum input voltage that can be applied to either switch terminal; that is, the input voltage should be between  $V_{CC-} + 8$  V and  $V_{CC+}$  to keep the on-state resistance within specified limits.

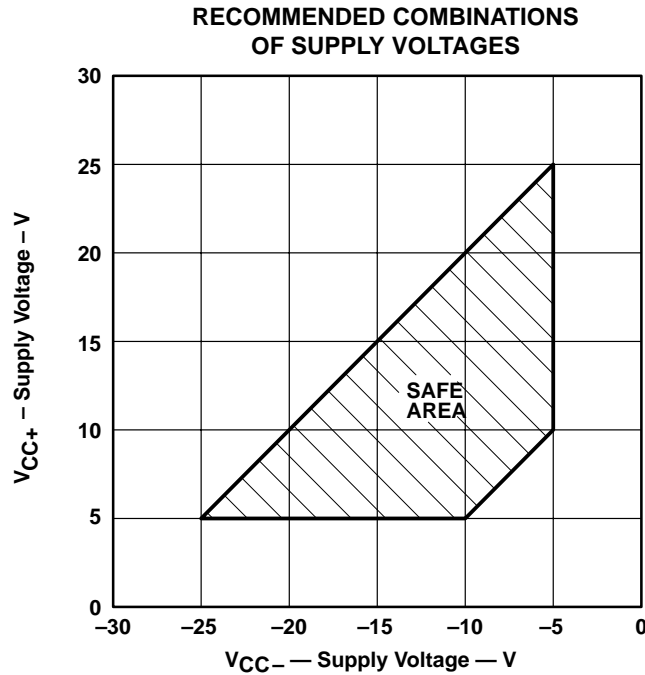
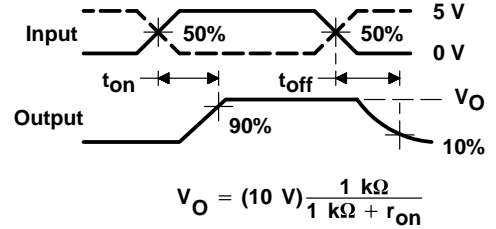
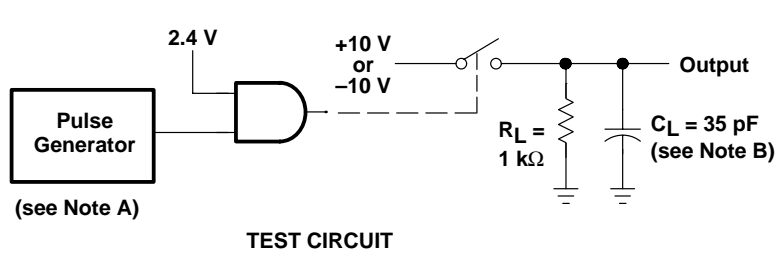

Figure 1

# TL601, TL604, TL607, TL610 P-MOS ANALOG SWITCHES

D2161, JUNE 1976 — REVISED OCTOBER 1986

## PARAMETER MEASUREMENT INFORMATION



NOTES: A. The pulse generator has the following characteristics:  $Z_O = 50 \Omega$ ,  $t_r \geq 15 \text{ ns}$ ,  $t_f \geq 15 \text{ ns}$ ,  $t_w = 500 \text{ ns}$ .  
B.  $C_L$  includes probe and jig capacitance.

Figure 2

## TYPICAL CHARACTERISTICS

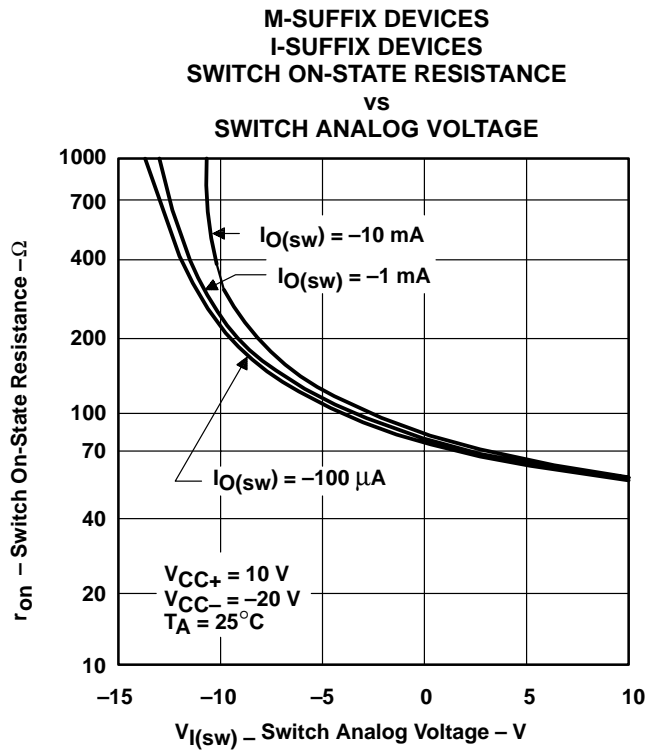

Figure 3

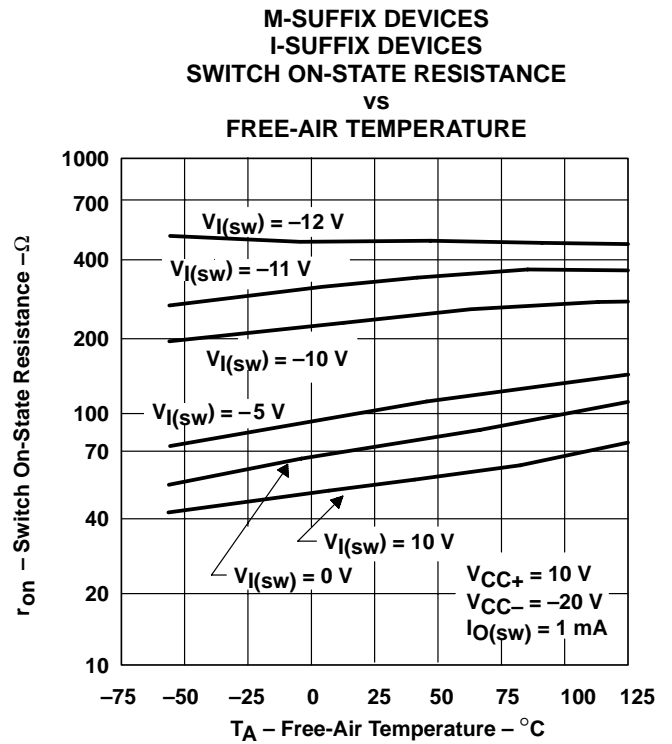

Figure 4

## **IMPORTANT NOTICE**

Texas Instruments (TI) reserves the right to make changes to its products or to discontinue any semiconductor product or service without notice, and advises its customers to obtain the latest version of relevant information to verify, before placing orders, that the information being relied on is current.

TI warrants performance of its semiconductor products and related software to the specifications applicable at the time of sale in accordance with TI's standard warranty. Testing and other quality control techniques are utilized to the extent TI deems necessary to support this warranty. Specific testing of all parameters of each device is not necessarily performed, except those mandated by government requirements.

Certain applications using semiconductor products may involve potential risks of death, personal injury, or severe property or environmental damage ("Critical Applications").

**TI SEMICONDUCTOR PRODUCTS ARE NOT DESIGNED, INTENDED, AUTHORIZED, OR WARRANTED TO BE SUITABLE FOR USE IN LIFE-SUPPORT APPLICATIONS, DEVICES OR SYSTEMS OR OTHER CRITICAL APPLICATIONS.**

Inclusion of TI products in such applications is understood to be fully at the risk of the customer. Use of TI products in such applications requires the written approval of an appropriate TI officer. Questions concerning potential risk applications should be directed to TI through a local SC sales office.

In order to minimize risks associated with the customer's applications, adequate design and operating safeguards should be provided by the customer to minimize inherent or procedural hazards.

TI assumes no liability for applications assistance, customer product design, software performance, or infringement of patents or services described herein. Nor does TI warrant or represent that any license, either express or implied, is granted under any patent right, copyright, mask work right, or other intellectual property right of TI covering or relating to any combination, machine, or process in which such semiconductor products or services might be or are used.