

LT1072, LT1072HV 1.25-A HIGH-EFFICIENCY SWITCHING REGULATORS

SLVS071A – NOVEMBER 1989 – REVISED AUGUST 1995

- **Wide Supply-Voltage Range:**
LT1072HV . . . 3 V to 60 V
LT1072 . . . 3 V to 40 V
- **Low Quiescent Current . . . 6 mA Typ**
- **Internal 1.25-A Switch**
- **Few External Parts Required**
- **Self-Protected Against Overloads**
- **Operates in Most Switching Configurations**
- **Low Shutdown-Mode Supply Current**
- **Floating Outputs in Flyback-Regulated Mode**
- **Can Be Externally Synchronized**

KC AND KV PACKAGE
(KV Package Used for Illustration)
(TOP VIEW)

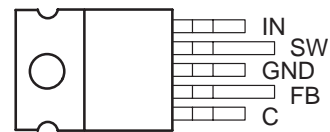

P Package
(TOP VIEW)

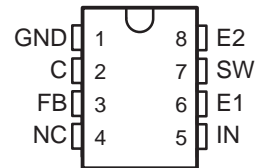

NC = No internal connection

AVAILABLE OPTIONS

T _J	MAX INPUT VOLTAGE	KC PACKAGE	KV PACKAGE	P PACKAGE
0°C to 100°C	60 V	LT1072HVCKC	LT1072HVCKV	LT1072HVC P
	40 V	LT1072CKC	LT1072CKV	LT1072CP
-40°C to 125°C	60 V	LT1072HVIKC	LT1072HVIKV	LT1072HVIP
	40 V	LT1072IKC	LT1072IKV	LT1072IP

description

The LT1072 is a monolithic, high-efficiency switching regulator. It can be operated in all standard switching configurations including: step-down (buck), step-up (boost), flyback, forward, inverting, and Cuk[†]. A high-current, high-efficiency switch is included in the package along with all oscillator, control, and protection circuitry. Integration of all functions allows the LT1072 to be built in standard 5-terminal KC or a KV packages and the 8-terminal P package. This makes it extremely easy to use and provides reliable operation similar to that obtained with 3-terminal linear regulators.

The LT1072 operates with supply voltages from 3 V to 40 V. The LT1072HV, a high-voltage version of the LT1072, operates with supply voltages from 3 V to 60 V. These devices draw only 6 mA of quiescent current, deliver load power up to 20 W with no external power devices, and by utilizing current-mode switching techniques, provide excellent ac and dc input and output regulation.

The LT1072 is much easier to use than the low-power control chips that are presently available and has many unique features that are not found on these chips. It uses an adaptive saturation-preventing switch drive to allow very-wide-ranging load currents with no loss in efficiency. An externally activated shutdown mode reduces total supply current to 50 μ A typical for standby operation. Totally isolated and regulated outputs can be generated by using the optional flyback-regulation mode built into the LT1072 without using optocouplers or extra transformer windings.

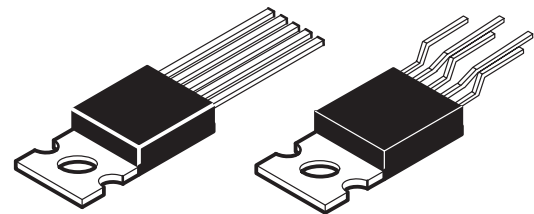

KC 5-Lead

KV 5-Lead

[†] A boost-buck-derived regulator circuit patented by Slobodan Cuk.

LT1072, LT1072HV 1.25-A HIGH-EFFICIENCY SWITCHING REGULATORS

SLVS071A – NOVEMBER 1989 – REVISED AUGUST 1995

Functional Block Diagram

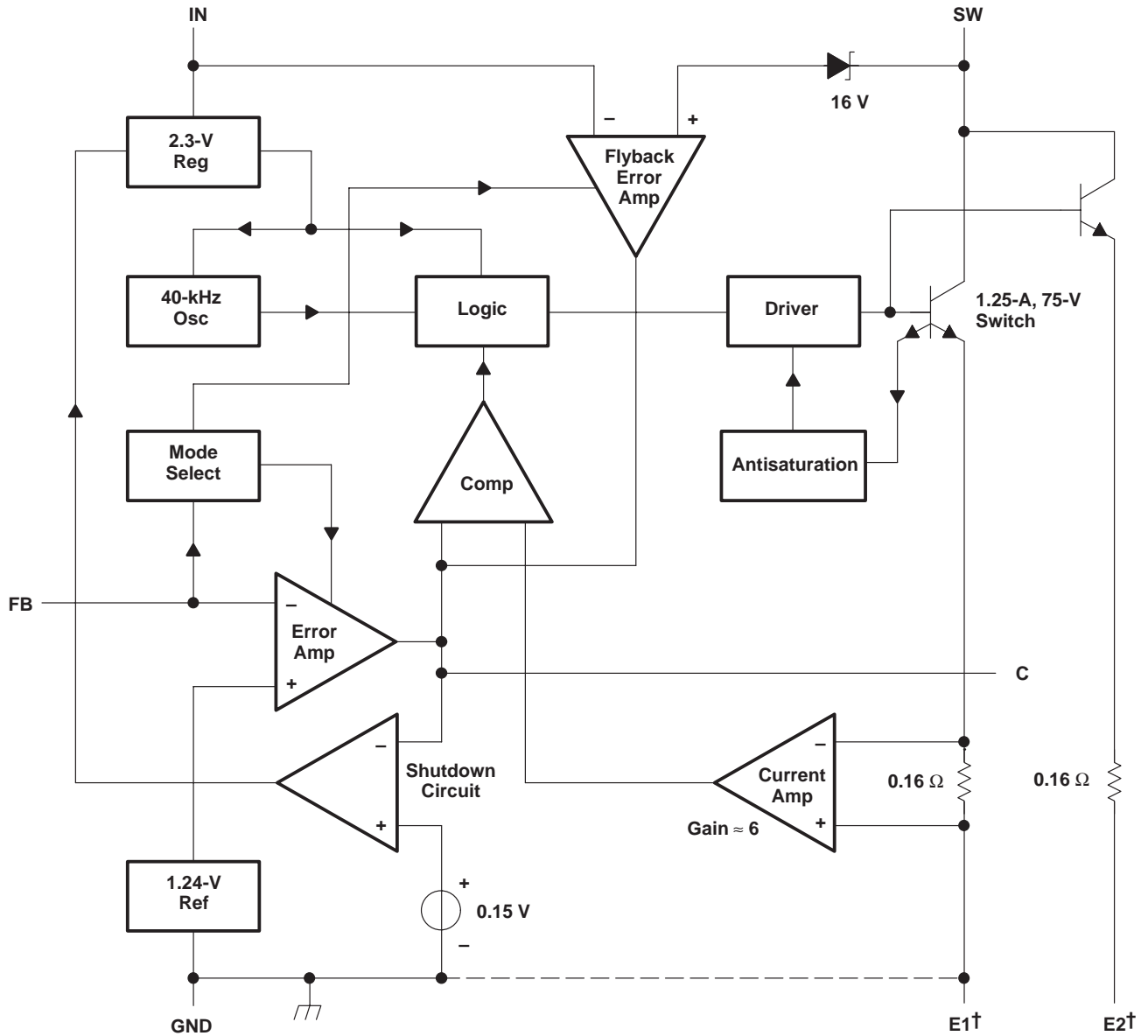

All resistor values shown are nominal.

† Always connect E1 to ground when using the P package. The emitters (E1 and E2) are tied internally to ground on the KC and KV packages.

LT1072, LT1072HV

1.25-A HIGH-EFFICIENCY SWITCHING REGULATORS

SLVS071A – NOVEMBER 1989 – REVISED AUGUST 1995

absolute maximum ratings over operating virtual junction temperature range (unless otherwise noted)†

Supply voltage, $V_{I(IN)}$ (see Note 1):	LT1072	40 V
	LT1072HV	60 V
Switch output voltage:	LT1072	65 V
	LT1072HV	75 V
Feedback input voltage, $V_{(FB)}$ (transient, 1 ms)	±15 V	
Continuous total dissipation	See Dissipation Rating Tables 1 and 2	
Operating virtual-junction temperature range, T_J :	LT1072C, LT1072HVC	0°C to 125°C
	LT1072I, LT1072HVI	–40°C to 125°C
Storage temperature range, T_{stg}	–65°C to 150°C	
Lead temperature 1,6 mm (1/16 inch) from case for 10 seconds	260°C	

† Stresses beyond those listed under “absolute maximum ratings” may cause permanent damage to the device. These are stress ratings only, and functional operation of the device at these or any other conditions beyond those indicated under “recommended operating conditions” is not implied. Exposure to absolute-maximum-rated conditions for extended periods may affect device reliability.

NOTE 1: Minimum switch-on time for the LT1072 in current limit is $\approx 0.7 \mu s$. This limits the maximum input voltage during short-circuit conditions, in the step-down and inverting modes only, to $\approx 40 V$. Normal (unshorted) conditions are not affected. If the LT1072 is being operated in the step-down or inverting mode at high input voltages and short-circuit conditions are expected, a resistor must be placed in series with the inductor.

DISSIPATION RATING TABLE 1 – FREE-AIR TEMPERATURE

PACKAGE	$T_A \leq 25^\circ C$ POWER RATING	DERATING FACTOR ABOVE $T_A = 25^\circ C$	$T_A = 125^\circ C$ POWER RATING
KC	2000 mW	16 mW/°C	400 mW
KV	2000 mW	16 mW/°C	400 mW
P	1000 mW	8 mW/°C	200 mW

DISSIPATION RATING TABLE 2 – CASE TEMPERATURE

PACKAGE	$T_C \leq 25^\circ C$ POWER RATING	DERATING FACTOR ABOVE $T_C = 70^\circ C$	$T_C = 125^\circ C$ POWER RATING
KC	20 W	250 mW/°C	6.25 W
KV	20 W	250 mW/°C	6.25 W

recommended operating conditions

		MIN	MAX	UNIT
Input Voltage, $V_{I(IN)}$	LT1072C, LT1072I	3	40	V
	LT1072HVC, LT1072HVI	3	60	
Virtual-junction temperature, T_J	LT1072C, LT1072HVC	0	100	°C
	LT1072I, LT1072HVI	–40	125	



LT1072, LT1072HV

1.25-A HIGH-EFFICIENCY SWITCHING REGULATORS

SLVS071A – NOVEMBER 1989 – REVISED AUGUST 1995

electrical characteristics at specified virtual junction temperature, $V_{IN} = 15\text{ V}$, $V_{FB} = V_{ref}$ with SW output open (unless otherwise noted)

reference section

PARAMETER		TEST CONDITIONS†	T_J ‡	MIN	TYP§	MAX	UNIT
V_{ref}	Output voltage	Measured at FB input, $V_{(C)} = 0.6\text{ V}$	25°C	1.224	1.244	1.264	V
			Full range	1.214		1.274	
	Input regulation	$V_{(IN)} = 3\text{ V to MAX}$, $V_{(C)} = 0.6\text{ V}$	Full range			0.03	%/V

error amplifier section

PARAMETER		TEST CONDITIONS†	T_J ‡	MIN	TYP§	MAX	UNIT
$I_{(FB)}$	Feedback input current	$V_{(FB)} = V_{ref}$	25°C		350	750	nA
			Full range			1100	
	Transconductance	$\Delta I_{(C)} = \pm 25\ \mu\text{A}$	25°C	3000	4400	6000	μmho
			Full range	2400		7000	
	Source current	$V_{(C)} = 1.5\text{ V}$, $V_{(FB)} = 0.8\text{ V}$	25°C	150	200	350	μA
			Full range	120		400	
	Sink current	$V_{(C)} = 1.5\text{ V}$, $V_{(FB)} = 1.5\text{ V}$	25°C	150	200	350	μA
			Full range	120		400	
$V_{O(C)}$	Output voltage	High state, $V_{(FB)} = 1\text{ V}$	25°C	1.8	0.38	2.3	V
		Low state, $V_{(FB)} = 1.5\text{ V}$					
A_V	Voltage amplification	$V_{(C)} = 0.7\text{ V to }1.4\text{ V}$	Full range	500	800	2000	V/V
$V_{(TO)(C)}$	Control threshold voltage	Duty cycle = 0	25°C	0.8	0.9	1.08	V
			Full range	0.6		1.25	

flyback amplifier section

PARAMETER		TEST CONDITIONS†	T_J ‡	MIN	TYP§	MAX	UNIT	
$V_{T(FB)}$	Flyback threshold voltage	$I_{(FB)} = 50\ \mu\text{A}$	25°C	0.4	0.45	0.54	V	
	Flyback threshold voltage	$I_{(FB)} = 50\ \mu\text{A}$, $I_{(C)} = -1\text{ to }+1\ \mu\text{A}$, $V_{(C)} = 0.6\text{ V}$	25°C	15	16.3	17.6	V	
			Full range	14		18		
	Change in flyback reference	$I_{(FB)} = 0.05\text{ to }1\ \text{mA}$, $I_{(C)} = -1\text{ to }+1\ \mu\text{A}$, $V_{(C)} = 0.6\text{ V}$	25°C	4.5	6.8	8.5	V	
	Flyback reference input regulation	$I_{(FB)} = 50\ \mu\text{A}$, $I_{(C)} = -1\text{ to }+1\ \mu\text{A}$, $V_{(IN)} = 3\text{ V to MAX}$, $V_{(C)} = 0.6\text{ V}$	25°C		0.01	0.03	%/V	
	Transconductance	$I_{(FB)} = 50\ \mu\text{A}$, $\Delta I_{(C)} \leq \pm 10\ \mu\text{A}$	25°C	150	300	500	μmho	
	Sink or source current	$V_{(C)} = 1.5\text{ V}$, $I_{(FB)} = 50\ \mu\text{A}$, $V_{(SW)} = V_Z + V_{(IN)} \pm 1\text{ V}$	Source	Full range	15	32	50	μA
			Sink					

† For conditions shown as MIN or MAX, use the appropriate value specified under the recommended operating conditions.

‡ Full range virtual junction temperature is 0°C to 100°C for LT1072C and LT1072HVC and -40°C to 125°C for LT1072L and LT1072HVL.

§ All typical values are $T_A = 25^\circ\text{C}$.



LT1072, LT1072HV

1.25-A HIGH-EFFICIENCY SWITCHING REGULATORS

SLVS071A – NOVEMBER 1989 – REVISED AUGUST 1995

electrical characteristics at specified virtual junction temperature, $V_{IN} = 15\text{ V}$, $V_{FB} = V_{ref}$ with SW output open (unless otherwise noted)

output section

PARAMETER		TEST CONDITIONS†	T_J ‡	MIN	TYP§	MAX	UNIT
$V_{(BR)(SW)}$	Switch breakdown voltage	$V_{(FB)} = 1.5\text{ V}$, $V_{(IN)} = 3\text{ V to MAX}$, $I_{(SW)} = 5\text{ mA}$	LT1072	Full range	65		V
			LT1072HV		75		
r_{on}	Switch on-state resistance	$V_{(FB)} = 0.8\text{ V}$, $I_{(SW)} = 1.25\text{ mA}$	Full range	0.6		1	Ω
	Control-to-switch transconductance		25°C	2			mho
$I_{(SW)(lim)}$	Switch current limit	$V_{(FB)} = 0.8\text{ V}$, See Note 2	Duty cycle $\leq 50\%$	$\geq 25^\circ\text{C}$	1.25	3	A
			Duty cycle $\leq 50\%$	$< 25^\circ\text{C}$	1.25	3.5	
			Duty cycle = 80%	Full range	1	2.5	
$\Delta I_{(IN)}/\Delta I_{(SW)}$	Input current increase during switch turn-on	$V_{(FB)} = 0.8\text{ V}$	25°C	25		35	mA/A
f	Frequency		25°C	35	40	45	kHz
			Full range	33		47	
	Maximum duty cycle	$V_{(FB)} = 1\text{ V}$	25°C	90%	92%	97%	
t_d	Flyback sense delay time		25°C	1.5			μs

shutdown section

PARAMETER		TEST CONDITIONS†	T_J ‡	MIN	TYP§	MAX	UNIT
$I_{off(IN)}$	Shutdown mode input current	$V_{(IN)} = 3\text{ V to MAX}$, $V_{(C)} = 0.05\text{ V}$	25°C	100		250	μA
$V_{(TO)(C)}$	Control threshold voltage	$V_{(IN)} = 3\text{ V to MAX}$	25°C	100	150	250	mV
			Full range	50		300	

total device

PARAMETER		TEST CONDITIONS†	T_J ‡	MIN	TYP§	MAX	UNIT
$V_{I(min)(IN)}$	Minimum input voltage		Full range	2.6		3	V
$I_{I(IN)}$	Input current	$V_{(IN)} = 3\text{ V to MAX}$, $V_{(C)} = 0.6\text{ V}$	25°C	6		9	mA

† For conditions shown as MIN or MAX, use the appropriate value specified under the recommended operating conditions.

‡ Full range virtual junction temperature is 0°C to 100°C for LT1072C and LT1072HVC and -40°C to 125°C for LT1072I and LT1072HVI.

§ All typical values are $T_A = 25^\circ\text{C}$.

NOTE 2: For duty cycles between 50% and 80%, minimum switch output current is given by $I_{(SW)(lim)} = 0.833$ (2-duty cycle).

LT1072, LT1072HV

1.25-A HIGH-EFFICIENCY SWITCHING REGULATORS

SLVS071A – NOVEMBER 1989 – REVISED AUGUST 1995

theory of operation

The LT1072 is a current-mode switcher. This means that the switch duty cycle is directly controlled by switch current rather than by output voltage. Referring to the functional block diagram, the switch is turned on at the start of each oscillator cycle. It is turned off when the switch current reaches a predetermined level. Control of output voltage is obtained by using the output of a voltage-sensing error amplifier to set the current trip level. This technique has several advantages. First, it has immediate response to input-voltage variations, which is unlike ordinary switchers that have poor input transient response. Second, it reduces the 90° phase shift at midfrequencies in the energy-storage inductor. This greatly simplifies closed-loop frequency compensation under widely varying input-voltage or output-load conditions. Finally, it allows simple pulse-by-pulse current limiting to provide maximum switch protection under output overload or short conditions. A low-dropout internal regulator provides a 2.3-V supply for all internal circuitry on the LT1072. This low-dropout design allows input voltage to vary from 3 V to 60 V with virtually no change in device performance. A 40-kHz oscillator is the basic clock for all internal timing. It turns on the output switch via the logic and driver circuitry. Special adaptive antisaturation circuitry detects the onset of saturation in the power switch and adjusts driver current instantaneously to limit switch saturation. This minimizes driver dissipation and provides very rapid turn off of the switch.

A 1.2-V band-gap reference biases the positive input of the error amplifier. The negative input is brought out for output-voltage sensing. This feedback terminal has a second function when pulled low with an external resistor. It programs the LT1072 to disconnect the main error-amplifier output and connects the output of the flyback amplifier to the comparator input. The LT1072 will then regulate the value of the flyback pulse with respect to the supply voltage. This flyback pulse is directly proportional to output voltage in the traditional transformer-coupled flyback-topology regulator. By regulating the amplitude of the flyback pulse, the output voltage can be regulated with no direct connection between input and output. The output is fully floating up to the breakdown voltage of the transformer windings. Multiple floating outputs are easily obtained with additional windings. A special delay network inside the LT1072 ignores the leakage inductance spike at the leading edge of the flyback pulse to improve output regulation.

The error signal developed at the comparator input is brought out externally. This terminal (C) has four different functions. It is used for frequency compensation, current limit adjustment, soft starting, and total regulator shutdown. During normal regulator operation, this terminal sits at a voltage between 0.9 V (low output current) and 2 V (high output current). The error amplifiers are current-output (g_m) types, so this voltage can be externally clamped for adjusting current limit. Likewise, a capacitor-coupled external clamp will provide soft start. Switch duty cycle goes to zero if the C terminal is pulled to ground through a diode. This places the LT1072 in an idle mode. Pulling the C terminal below 0.15 V causes total regulator shutdown, with only 50- μ A supply current for shutdown-circuitry biasing.

In the P package, the emitters of the power transistors are brought out separately from the ground terminal. This eliminates errors due to ground-terminal voltage drops and allows the user to reduce the switch-current limit (2:1) by leaving the second emitter (E2) disconnected. The first emitter (E1) should always be connected to the ground terminal. Note that switch on-state resistance doubles when E2 is left open, so efficiency will suffer somewhat when switch currents exceed 100 mA. Also, note that chip dissipation will actually *increase* with E2 open during normal load operations, even though dissipation in current-limit mode will *decrease*.

TYPICAL CHARACTERISTICS

Table of Graphs

			FIGURE
P_{OM}	Maximum output power	vs Input voltage	1
V_{ref}	Reference voltage	vs Junction temperature	2
f	Switching frequency	vs Junction temperature	2
	Reference voltage change	vs Input voltage	3
I_{FB}	Feedback input current	vs Junction temperature	4
g_m	Error amplifier transconductance	vs Junction temperature	5
g_m	Error amplifier transconductance	vs Frequency	6
	Error amplifier phase shift	vs Frequency	6
I_C	Control current	vs Control voltage	7
$V_{T(FB)}$	Normal/flyback mode threshold voltage	vs Junction temperature	8
I_{FB}	Feedback input current	vs Junction temperature	8
V_Z	Flyback reference voltage	vs Junction temperature	9
t_d	Flyback sense delay time	vs Junction temperature	10
$I_{O(SW)}$	Switch output current (with switch off)	vs Switch voltage	11
	Driver base current	vs Switch output current	12
$V_{sat(SW)}$	Switch saturation voltage	vs Switch output current	13
$I_{O(SW)}$	Switch output current limit	vs Duty cycle	14
	Maximum duty cycle	vs Junction temperature	15
I_{IN}	Shutdown-mode input current	vs Control voltage	16
I_{IN}	Shutdown-mode input current	vs Input voltage	17
$V_{T(C)}$	Shutdown-mode control threshold voltage	vs Junction temperature	18
$I_{T(C)}$	Shutdown-mode control threshold current	vs Junction temperature	18
V_{FB}	Feedback input voltage at normal/flyback mode threshold	vs Feedback input current	19
	Minimum input voltage	vs Junction temperature	20
I_{IN}	Input current (SW output open)	vs Junction temperature	21
I_{IN}	Input current	vs Input voltage	22

Table of Application Circuits

APPLICATION	FIGURE
Totally isolated converter	23
Boost converter (5 V to 12 V)	24

LT1072, LT1072HV 1.25-A HIGH-EFFICIENCY SWITCHING REGULATORS

SLVS071A – NOVEMBER 1989 – REVISED AUGUST 1995

TYPICAL CHARACTERISTICS

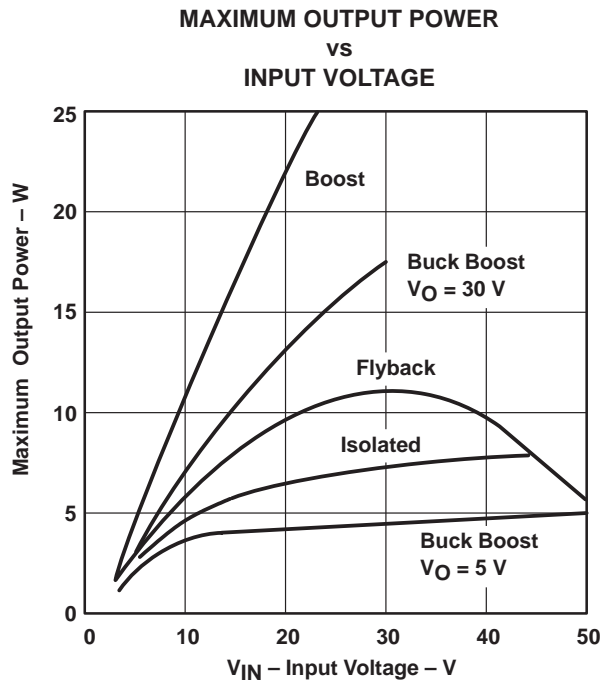

Figure 1

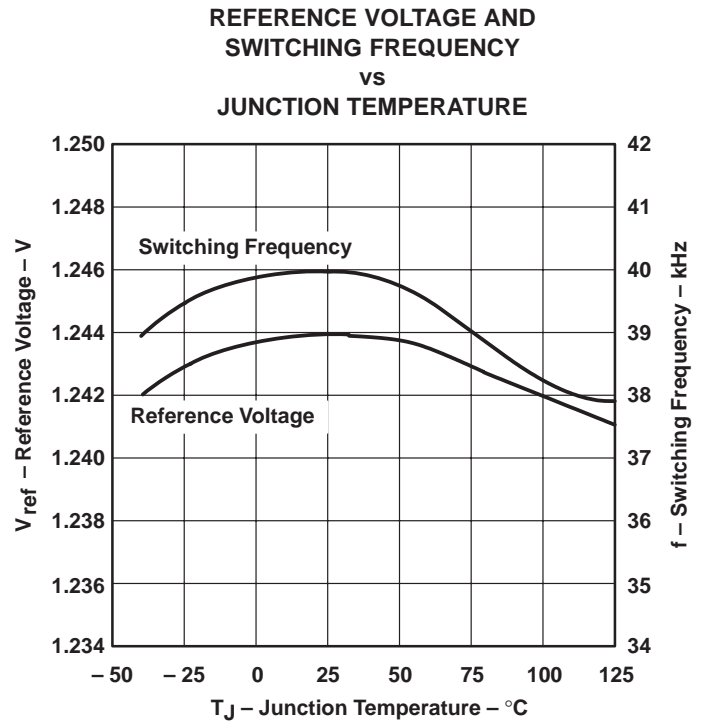

Figure 2

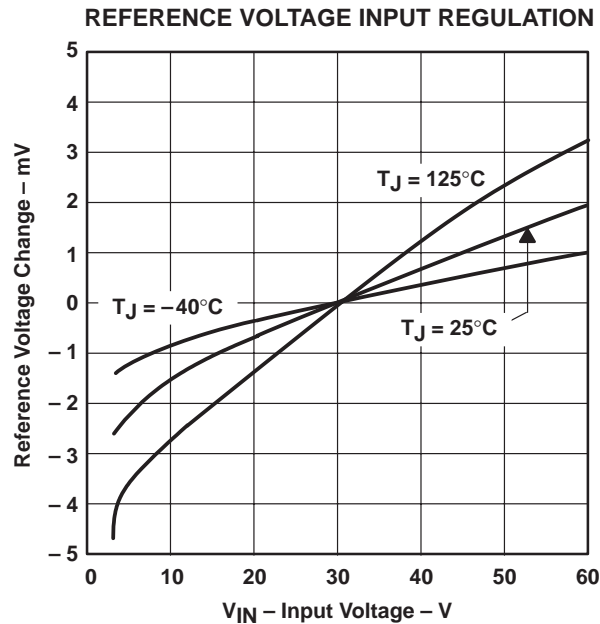

Figure 3

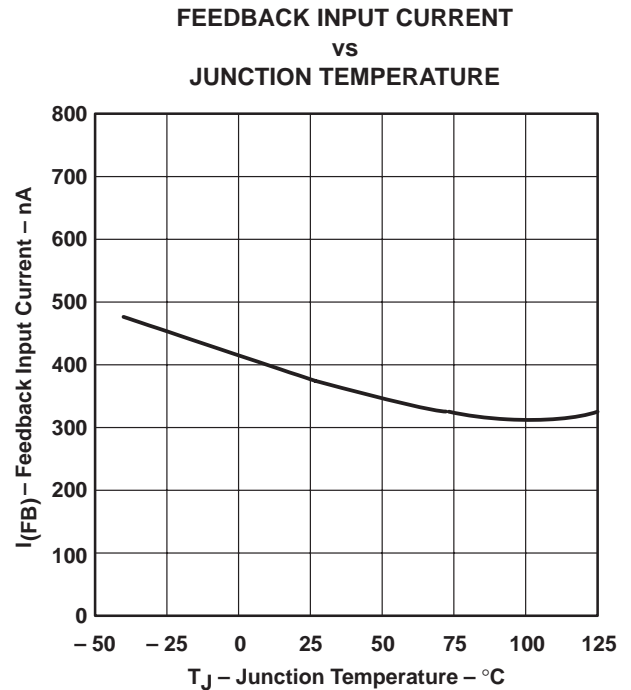

Figure 4

TYPICAL CHARACTERISTICS

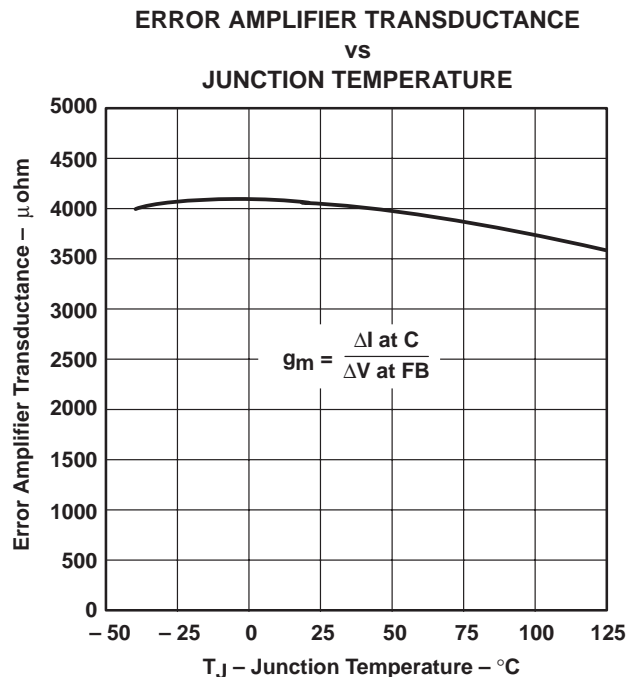

Figure 5

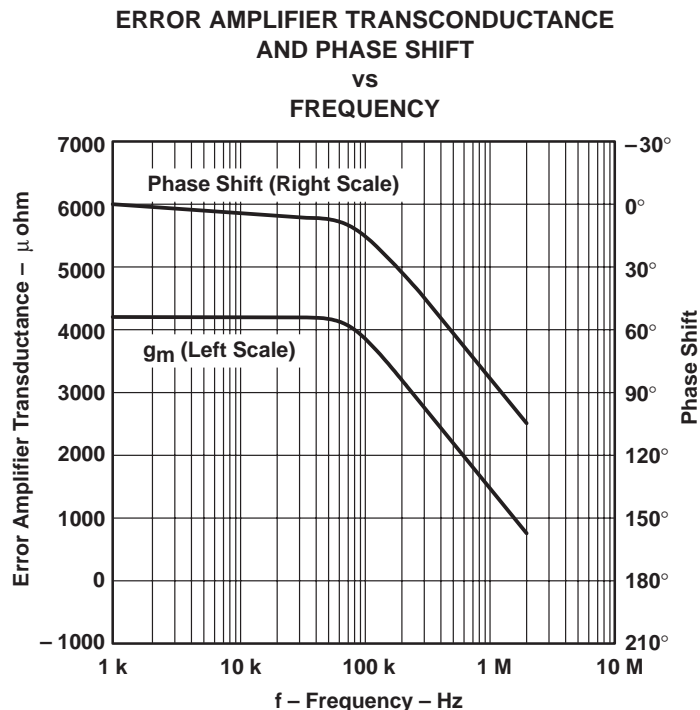

Figure 6

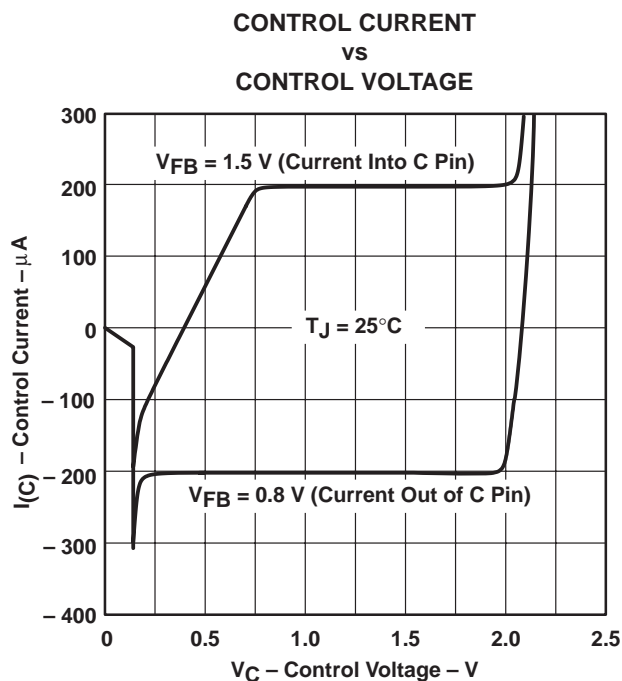

Figure 7

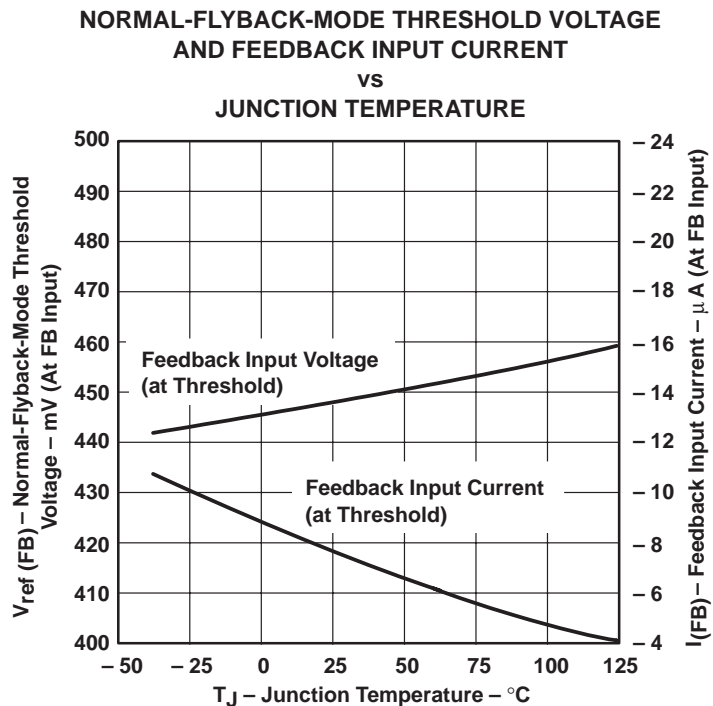

Figure 8

LT1072, LT1072HV 1.25-A HIGH-EFFICIENCY SWITCHING REGULATORS

SLVS071A – NOVEMBER 1989 – REVISED AUGUST 1995

TYPICAL CHARACTERISTICS

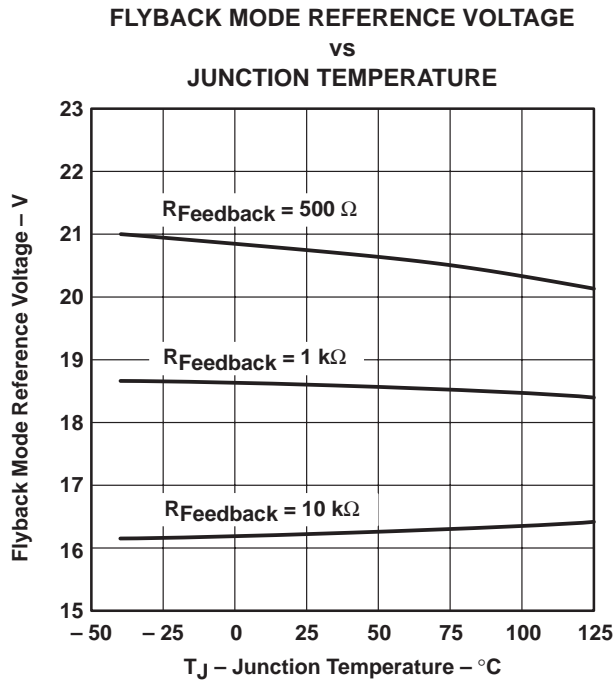

Figure 9

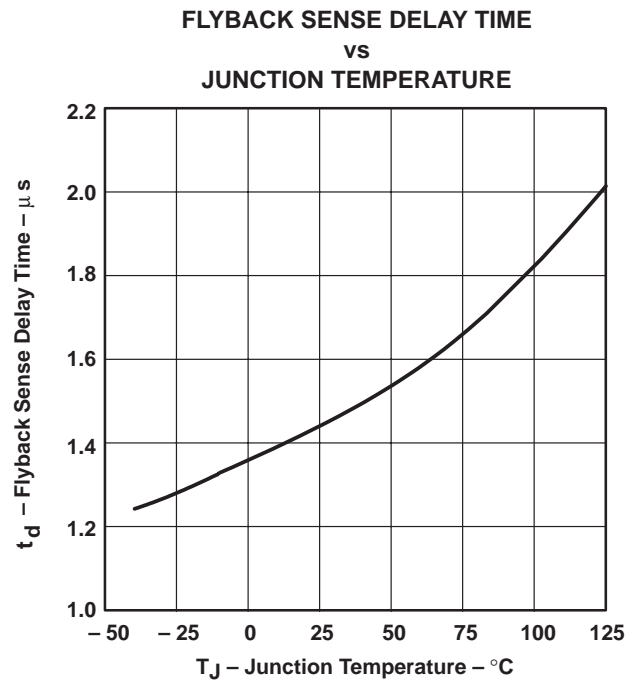

Figure 10

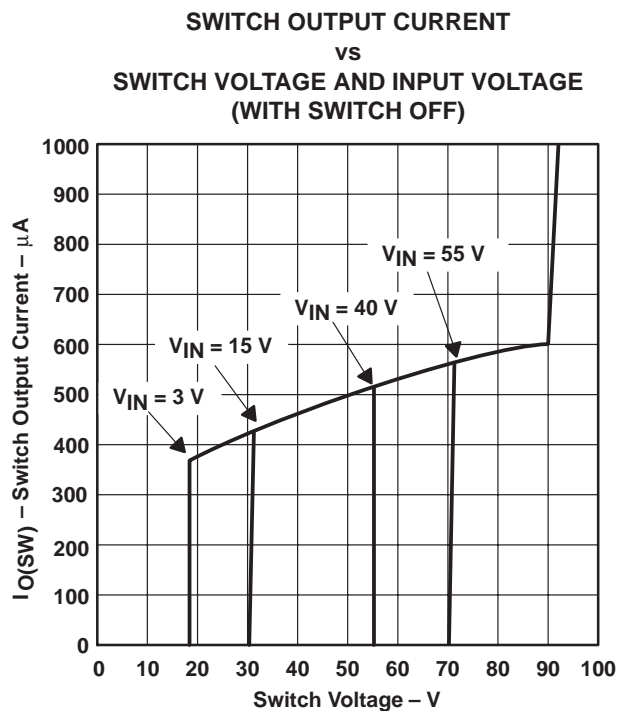
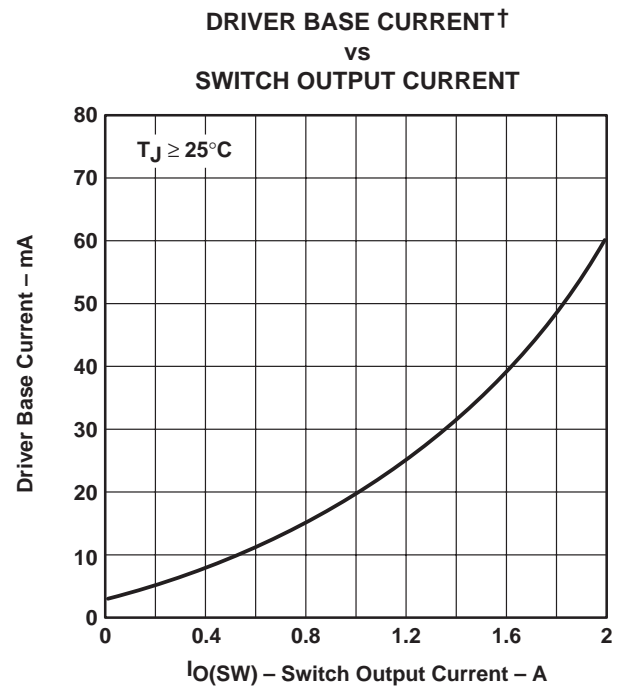

Figure 11



† Average input current is found by multiplying driver base by duty cycle plus quiescent current.

Figure 12

TYPICAL CHARACTERISTICS

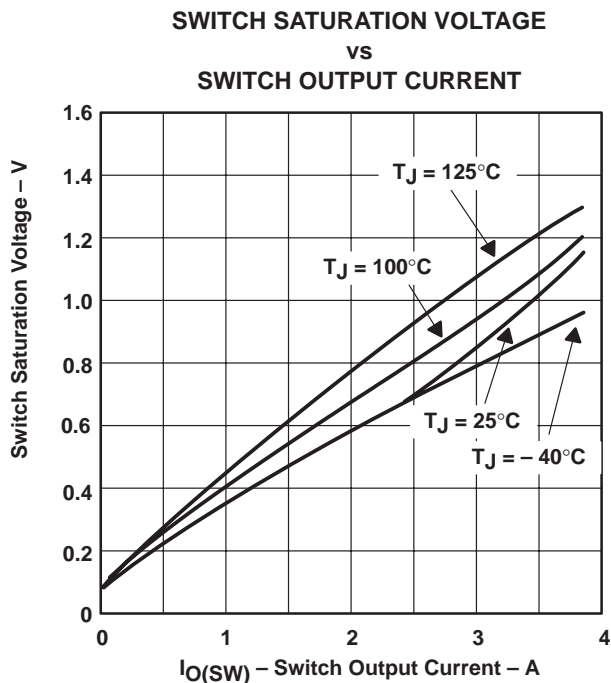

Figure 13

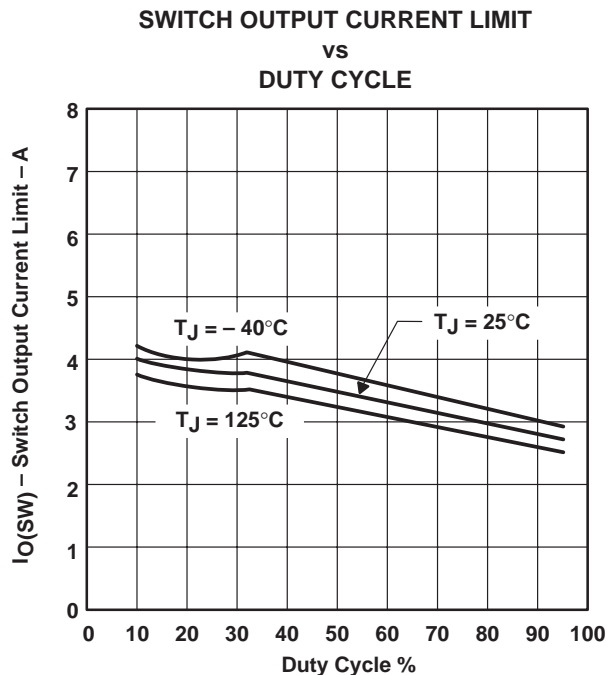

Figure 14

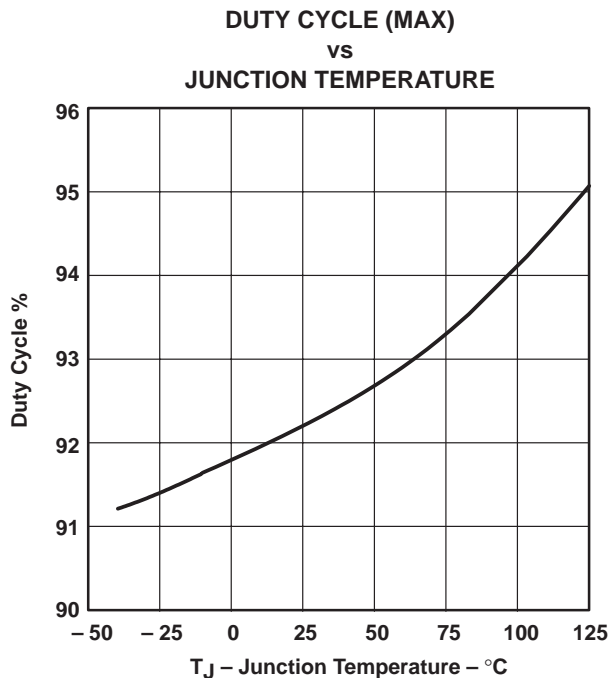

Figure 15

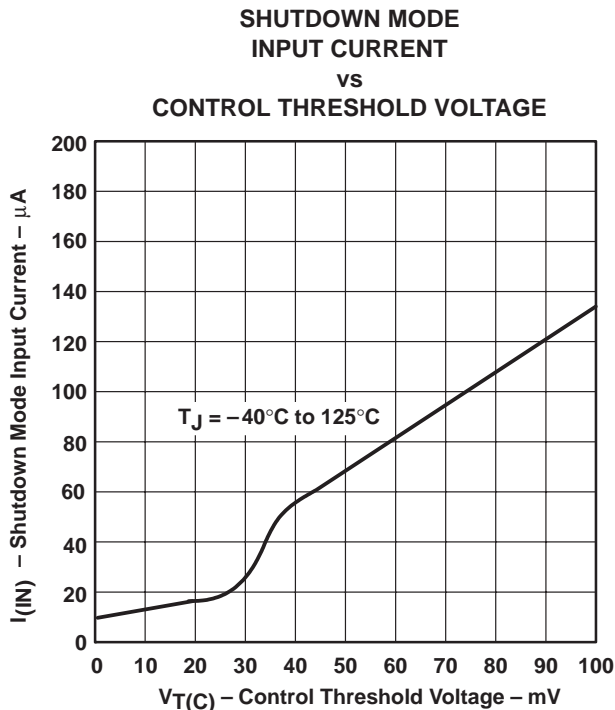

Figure 16

LT1072, LT1072HV 1.25-A HIGH-EFFICIENCY SWITCHING REGULATORS

SLVS071A – NOVEMBER 1989 – REVISED AUGUST 1995

TYPICAL CHARACTERISTICS

SHUTDOWN MODE
INPUT CURRENT
vs
INPUT VOLTAGE

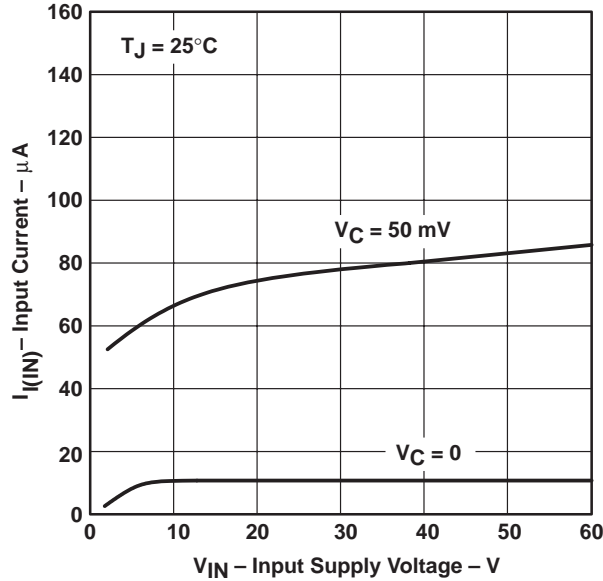

Figure 17

SHUTDOWN MODE
CONTROL THRESHOLD VOLTAGE AND CURRENT
vs
JUNCTION TEMPERATURE

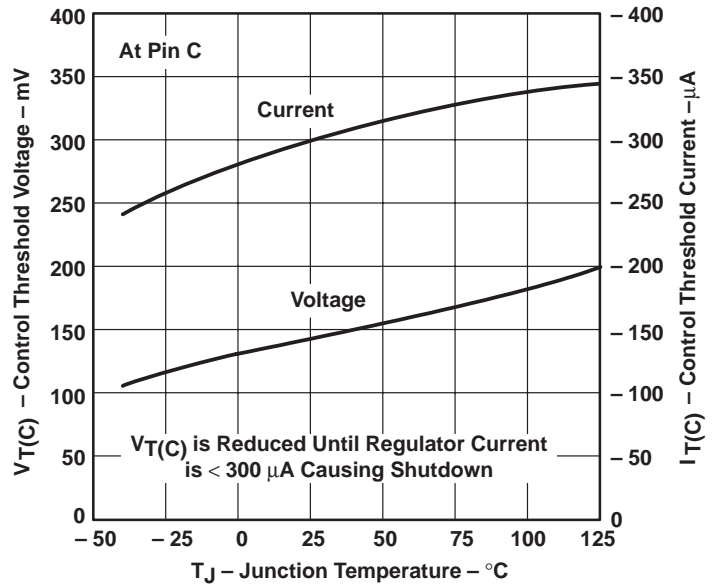

Figure 18

FEEDBACK INPUT VOLTAGE
vs
FEEDBACK INPUT CURRENT

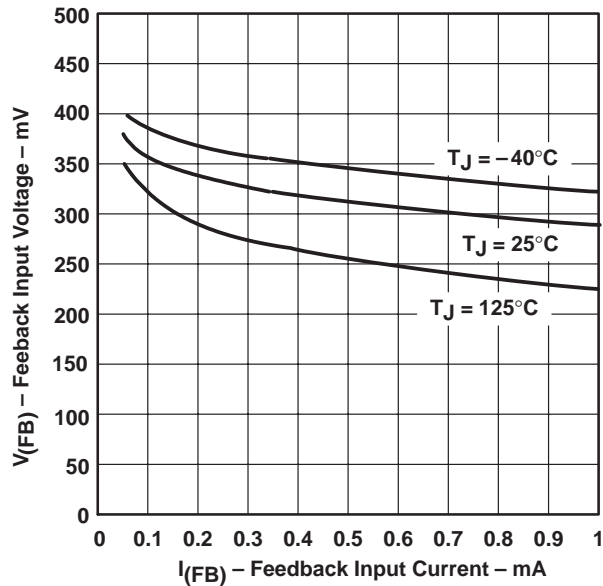

Figure 19

MINIMUM INPUT VOLTAGE
vs
JUNCTION TEMPERATURE

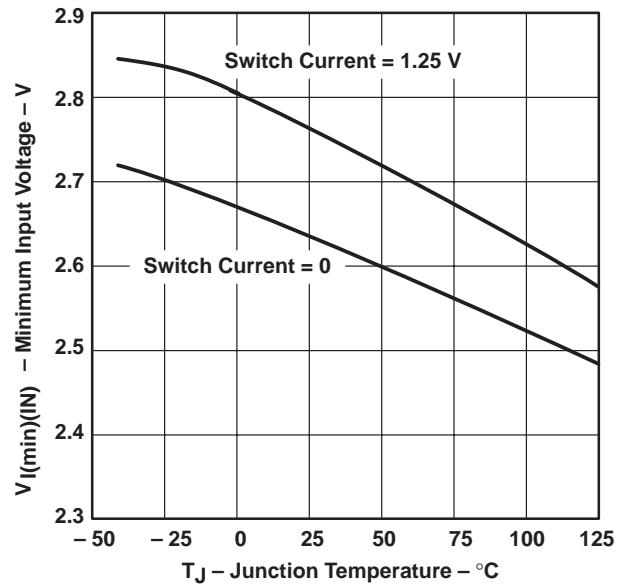

Figure 20

TYPICAL CHARACTERISTICS

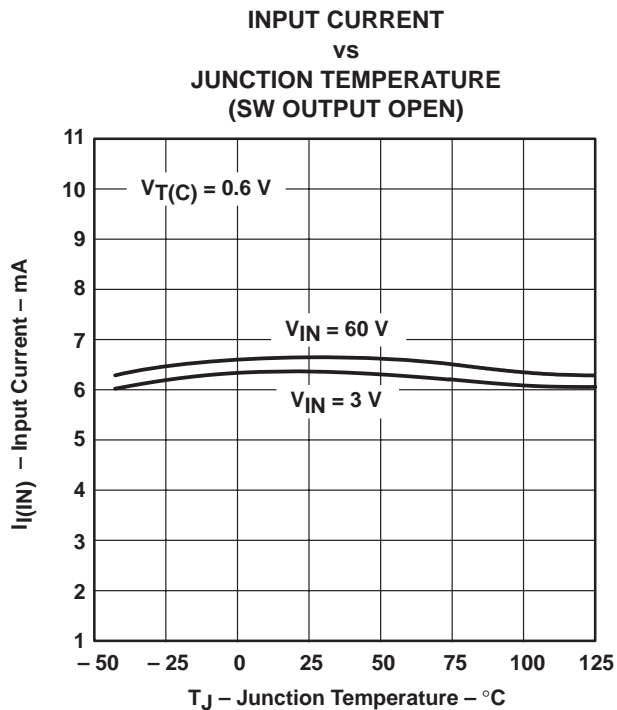
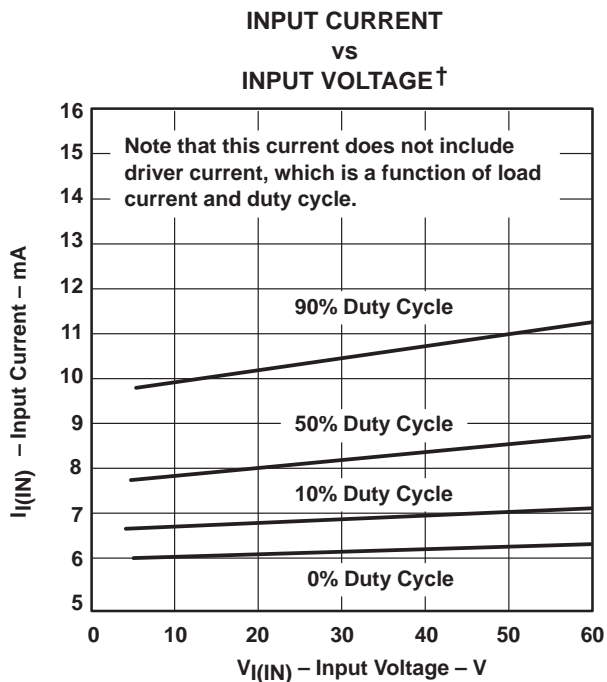

Figure 21



† Under very low output current conditions, duty cycle for most circuits will approach 10% or less.

Figure 22

LT1072, LT1072HV 1.25-A HIGH-EFFICIENCY SWITCHING REGULATORS

SLVS071A – NOVEMBER 1989 – REVISED AUGUST 1995

APPLICATION INFORMATION

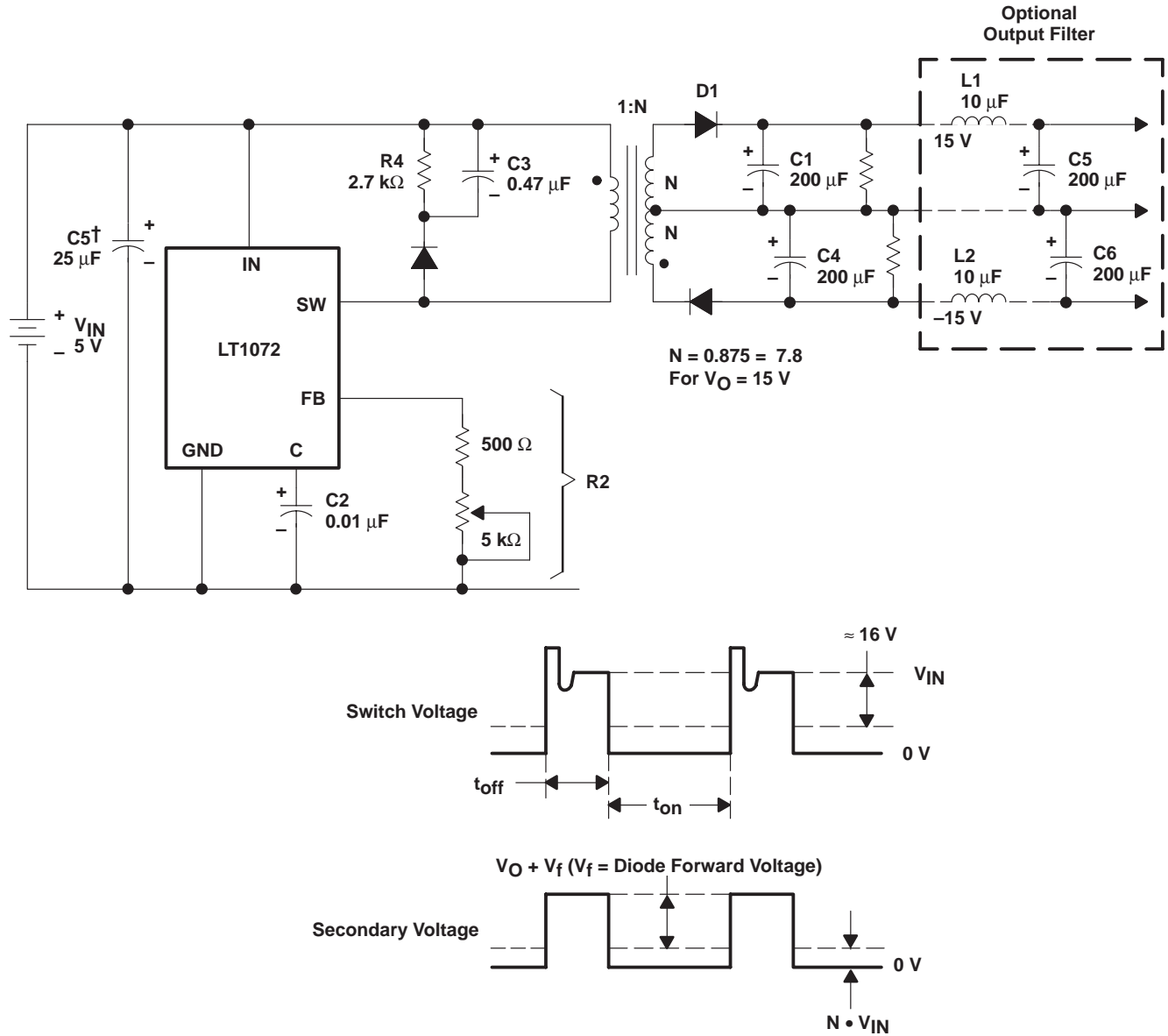

† Capacitors are required if input leads ≥ 2 inches.

Figure 23. Totally Isolated Converter

APPLICATION INFORMATION

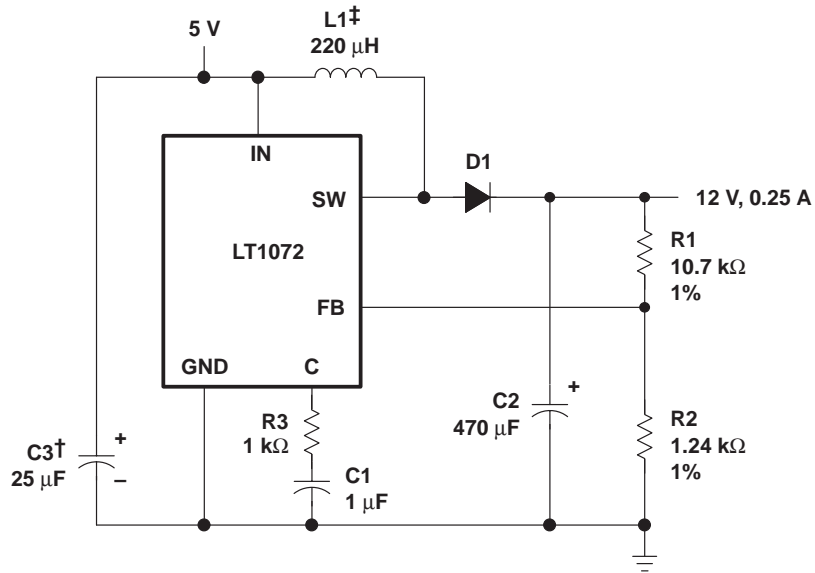

† Capacitor is required if input leads ≥ 2 inches.
‡ Pulse Engineering 52626

Figure 24. Boost Converter (5 V to 12 V)

IMPORTANT NOTICE

Texas Instruments and its subsidiaries (TI) reserve the right to make changes to their products or to discontinue any product or service without notice, and advise customers to obtain the latest version of relevant information to verify, before placing orders, that information being relied on is current and complete. All products are sold subject to the terms and conditions of sale supplied at the time of order acknowledgement, including those pertaining to warranty, patent infringement, and limitation of liability.

TI warrants performance of its semiconductor products to the specifications applicable at the time of sale in accordance with TI's standard warranty. Testing and other quality control techniques are utilized to the extent TI deems necessary to support this warranty. Specific testing of all parameters of each device is not necessarily performed, except those mandated by government requirements.

CERTAIN APPLICATIONS USING SEMICONDUCTOR PRODUCTS MAY INVOLVE POTENTIAL RISKS OF DEATH, PERSONAL INJURY, OR SEVERE PROPERTY OR ENVIRONMENTAL DAMAGE ("CRITICAL APPLICATIONS"). TI SEMICONDUCTOR PRODUCTS ARE NOT DESIGNED, AUTHORIZED, OR WARRANTED TO BE SUITABLE FOR USE IN LIFE-SUPPORT DEVICES OR SYSTEMS OR OTHER CRITICAL APPLICATIONS. INCLUSION OF TI PRODUCTS IN SUCH APPLICATIONS IS UNDERSTOOD TO BE FULLY AT THE CUSTOMER'S RISK.

In order to minimize risks associated with the customer's applications, adequate design and operating safeguards must be provided by the customer to minimize inherent or procedural hazards.

TI assumes no liability for applications assistance or customer product design. TI does not warrant or represent that any license, either express or implied, is granted under any patent right, copyright, mask work right, or other intellectual property right of TI covering or relating to any combination, machine, or process in which such semiconductor products or services might be or are used. TI's publication of information regarding any third party's products or services does not constitute TI's approval, warranty or endorsement thereof.