

SINGLE-CHIP FREQUENCY CONVERTER

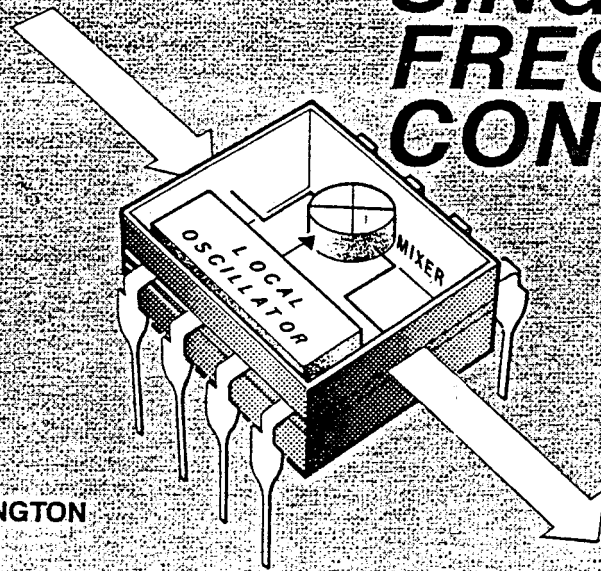

MICHAEL A. COVINGTON

Introducing a general-purpose single-chip frequency converter which should greatly simplify your RF designs.

FREQUENCY CONVERTERS ARE BASIC building blocks of RF equipment. You'll find them wherever there's a need to shift the RF carrier of a signal from one frequency to another, such as in any modern radio receiver.

Frequency conversion, or heterodyning, is the process of mixing an incoming signal with that of a Local Oscillator (LO), as shown in Fig. 1. Two signals result from mixing, their frequencies being the sum and difference of those of the originals. Thus, a 9-MHz input and a 2-MHz LO yield outputs of 7 and 11 MHz.

Building a frequency converter is easier now than it's ever been because of a new IC, the Signetics NE602. The NE602 contains an LO and double-balanced mixer in an 8-pin DIP, as shown in Fig. 2, a block diagram of the IC. The NE602 was originally designed for VHF receiver front ends, since the LO works up to 200 MHz, and the mixer to 500 MHz. However, it has plenty of uses at lower frequencies as well, and this article will explore them.

the output of an NE602 directly to a receiver without overloading it. With a conventional mixer, you'd have to add a tuned LC circuit to eliminate the LO output. The NE602 LO is also well isolated from its RF input; you can thus connect a receiving antenna directly to the RF input terminals of the IC without worrying about radiating the LO signal back out through the antenna. This is important in direct-conversion receivers, where the LO frequency is so close to that of the input, that the two can't be isolated by a tuned LC circuit.

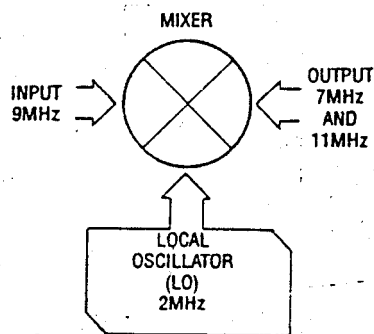

FIG. 1.—FREQUENCY CONVERSION PRODUCES outputs at the sum and difference of input and LO frequencies. In the case of the NE602, since it's double-balanced, both the input and LO signals are absent from the output.

The combination of the differential amplifier and mixer in the NE602 is known as a Gilbert cell. The mixer has on-board voltage regulation, and draws 2.5–3 mA at 4.5–8 volts. For best performance, bypass the power supply with a 0.04- μ F capacitor as close to the IC as possible. The absolute maximum supply voltage is 9.0 volts, but a 9-volt battery often exceeds that, and 9-volt wall transformers often deliver as much as 11 volts. For safety, use 1000-ohm dropping resistor R1 as shown in Fig. 3; using a Zener diode, you can use automotive power supplies up to 18 volts.

The RF input and mixer output can be either single-ended or balanced as shown in Figs. 4 and 5. Using a balanced input reduces harmonics, while a balanced output gives better suppression of the input RF and LO signals. However, even in the simplest single-ended configuration, the NE602 gives much better performance than the one-transistor mixer commonly found in receivers.

The input and output impedances of the NE602 are about 1.5K at low frequencies, and decrease with increasing frequency. The input signal should be weak to prevent harmonics; the third-order intercept point is for a -15 dBm input, but the recommended

Circuit description

The NE602 uses a double-balanced mixer, producing only the sum and difference frequencies, not that of the RF input or LO. You can thus connect

level is -25 dBm or below. That corresponds to 68.87 millivolts into 1.5K if you use direct coupling, or 12.82 millivolts into 52 ohms if you use impedance matching. The NE602 works well with microvolt-level signals from antennas.

The input signal is amplified prior to mixing; the voltage gain is about 10. Thus, a receiving converter built with the NE602 can increase a receiver's sensitivity. The NE602 LO is a transistor with connections to its base and emitter, with biasing hand-

dled on the chip. That makes it easy to build many different oscillator types with few external components.

Figure 6 shows some of the main versions; there are many others. The NE602 can be used as an oscillator without the mixer. One way is to sample the LO output at pin 7; a better way is to unbalance the mixer and use it to amplify the LO signal, as shown in Fig. 7. The unbalance is created by a 10K resistor from one input pin to ground, which changes the bias voltage slightly. The output level of such an oscillator is about 0.5 VAC P-P.

Basic crystal oscillator

Many frequency converters are crystal-controlled; Fig. 8 shows the most basic version. The low side of XTAL1 and C2 can be returned either to ground or to V_{CC} ; the latter is more compact, because pins 6 and 7 are adjacent to V_{CC} (pin 8). The values of C1 and C2 are important. If C1 is too large, or C2 is too small, there's too much feedback and the oscillator waveform is distorted, with a strong third harmonic. If C1 is too small or C2 is too large, oscillation doesn't occur.

Some suggested values for C1 and C2 are shown in Fig. 6 along with formulae for calculating them. At high frequencies, C1 can be somewhat than the value shown because stray capacitance does some of the work. The values shown are for the best sinusoid. If you want to be sure that a relatively inactive crystal will oscillate and don't mind harmonics, make C1 three times larger. The third harmonic from such a circuit could be used for VHF. There's also a lower frequency limit: the unmodified circuit will oscillate with a 455-kHz ceramic resonator, but not a 100-kHz crystal. Adding 22K from pin 7 to ground will increase the oscillator gain, and improve your chances with low-frequency crystals.

Precise frequency control

A crystal won't necessarily oscillate at its exact rated frequency. There are two kinds, series- and parallel-resonant. They're electrically identical, the only difference being that series-resonant crystals are cut to an exact frequency, whereas parallel-resonant crystals are cut slightly longer, so as to resonate independently slightly below their rated frequency. For that reason, parallel-resonant

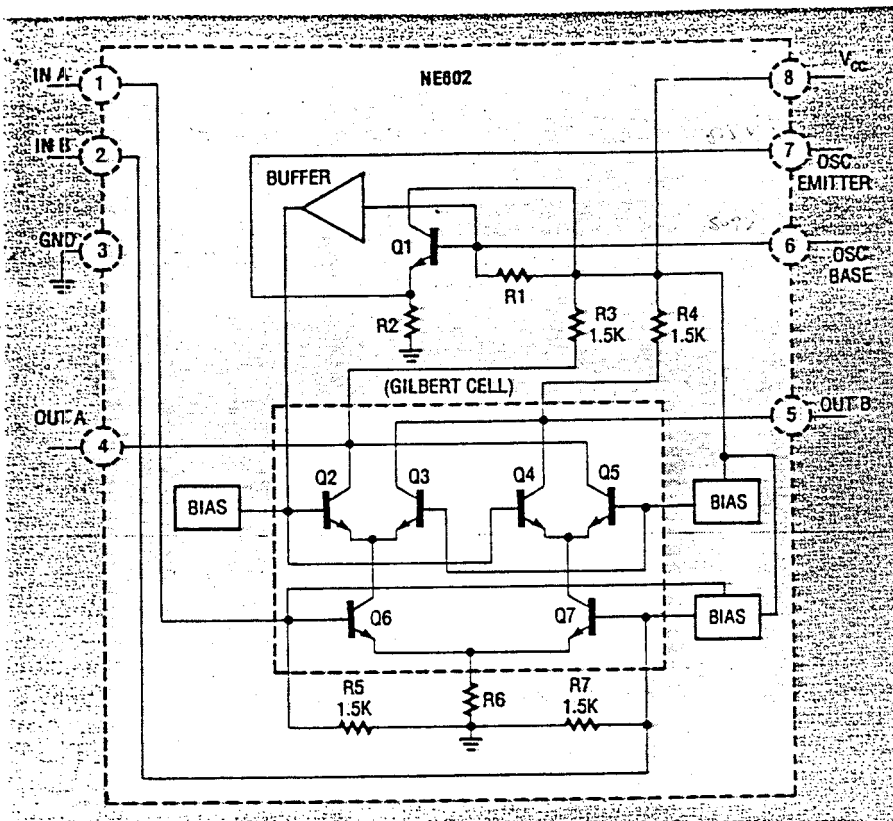

FIG. 2.—NE602 EQUIVALENT CIRCUIT WITH PINOUTS. The combination of differential amplifier Q6-Q7 and mixers Q2-Q3 and Q4-Q5 is called a Gilbert cell.

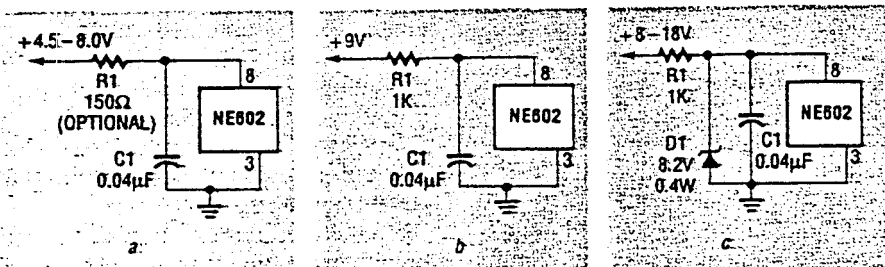

FIG. 3.—NE602 POWER SUPPLY OPTIONS. Here, (a)-(c) show an RC-filter used as both current limiter (R1) and integrator (C1), as well as for isolation. In (a), +4.5-8.0 volts DC is the normal operating range of the NE602. In (b), R1 drops voltage, and is used since a +9-volt battery can go higher, and a +9-volt wall supply can produce up to 11 volts. In (c), an +8-18 volt DC supply is regulated using 8.2-volt Zener D1.

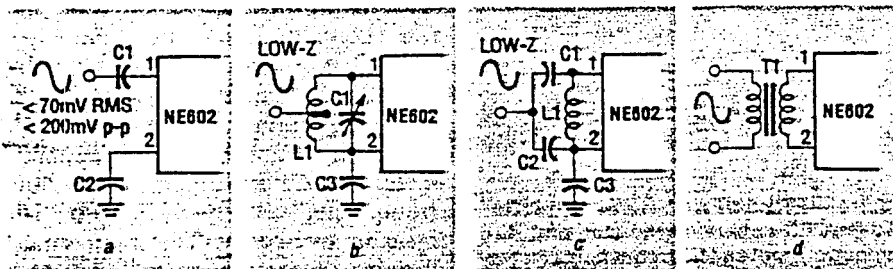

FIG. 4.—MIXER RF INPUT CONFIGURATIONS. Here, (a)-(c) are for single-ended coupling, (a) being for no impedance matching, (b) for inductive matching, (c) for capacitive matching. By contrast, (d) is for a balanced input with reduced second harmonic.

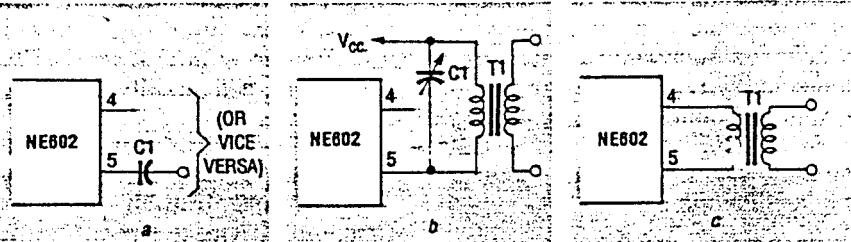

FIG. 5.—OUTPUT CONFIGURATIONS. Here, (a) is the simplest single-ended approach without impedance matching, (b) is a single-ended approach for a tuned LC circuit load, and (c) is for a balanced approach for better suppression of input and LO signals.

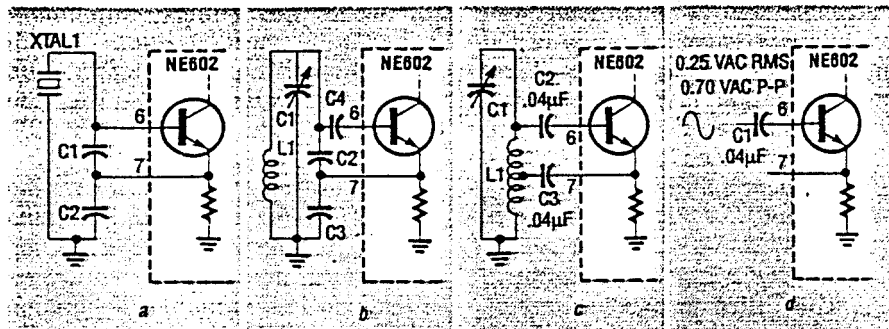

FIG. 6.—BASIC NE602 OSCILLATOR CIRCUITS: (a) is Colpitts crystal-controlled, (b) is Colpitts LC-tank-controlled, (c) is Hartley LC-tank-controlled, and (d) is controlled by an external oscillator. Many other configurations are possible.

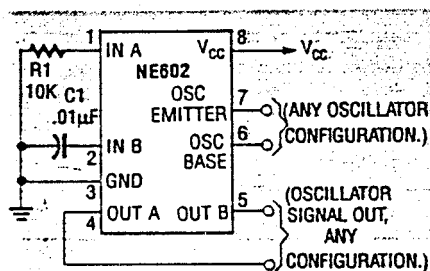

FIG. 7.—THIS IS A GENERAL CONFIGURATION for an NE602. To make an LO signal appear at out A (pin 4) and out B (pin 5), IN A (pin 1) is grounded through R1.

crystals need external capacitors (usually 32 pF) to increase their actual frequency of oscillation to their rated value. In Fig. 8, C1 is this capacitor, but it's usually larger than 32 pF and has less effect than the one depicted here.

Thus, at 10 MHz, parallel-resonant crystals oscillate about 100 parts per million (ppm) below their rated frequency, while series crystals resonate about 300 ppm above. A parallel-resonant crystal can be pulled up to its rated frequency using a small variable capacitor in series with it, as in Fig. 9, letting you adjust the oscillator as desired. However, even without this capacitor, the frequency error won't be more than 300 ppm (0.03%).

Overtone crystal oscillator

Above 20 MHz, crystals oscillate in overtone mode, and the oscillator

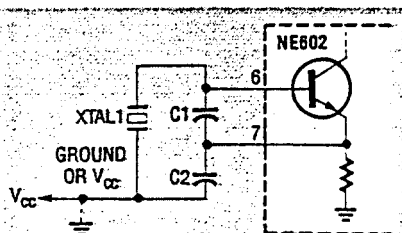

f MHz	C1=100pF/√f	C2=1000pF/f
1	100	1000
2	70	500
4	50	250
10	32	100
20	22	50

FIG. 8.—FUNDAMENTAL COLPITTS CRYSTAL OSCILLATOR. Note that the juncture of XTAL1 and C2 can go to either ground or V_{CC}.

needs a tuned LC circuit to select the desired harmonic. For example, a 27-MHz third-harmonic crystal can resonate at 9 MHz (fundamental) or 45 MHz (fifth harmonic). The NE602

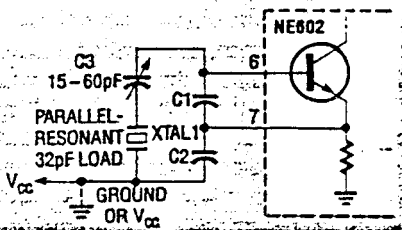

FIG. 9.—A VARIATION ON FIG. 8, including C3 to adjust the frequency of XTAL1 (parallel-resonant), bringing it up to its rated value.

data sheet recommends a modified Colpitts oscillator for overtone crystals, but the Butler oscillator in Fig. 10 gives much better results. Its crystal is series-resonant, and L₁ and C1 are tuned to the crystal frequency.

This circuit is reliable to at least 60 MHz. Just adjust L₁ and C1 until oscillation occurs. By adjusting this tuned LC circuit, you can trim the frequency by about 50 ppm; for greater variation, use a parallel-resonant crystal in series with a variable capacitor for adjustments.

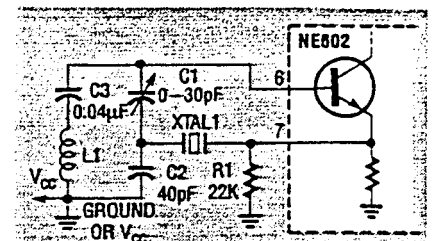

FIG. 10.—BUTLER OVERTONE CRYSTAL OSCILLATOR, with C1 as trimmer. Here: L₁=1300 μH, and both L₁ and C1 have to be tuned to the frequency of XTAL1.

Frequency doubler

Figure 11 shows a crystal-controlled frequency doubler with no tuned LC circuits. That circuit is useful in the 20–40 MHz range, but the same method could be used with overtone crystal oscillators for even higher output frequencies.

The doubling is achieved by feeding the LO from pin 7 into the mixer. The output is 2×f (where f is the oscillator fundamental frequency), while the difference frequency is zero (or DC), disappearing due to capacitive coupling.

The output still contains some energy at the LO frequency and isn't pure, but is good enough for hobbyist purposes. A tuned LC circuit can easily provide pure output. Of the oscillators shown here, this is the only one that can't be used with the mixer, because one mixer input is occupied (although you could feed a signal to the other mixer input).

Figure 12 shows a Colpitts LC oscillator using coils and capacitors. Here, L₁ forms a resonant circuit with C1 and C2 in series, plus C4 in parallel. Also, C3 blocks DC from pin 6 to V_{CC} or ground: it has little effect on the resonant frequency. Figure 12 also gives formulas for component values. At very high frequencies, a 22K resistor from pin 7 to ground (not V_{CC}) will change the bias point and increase gain.

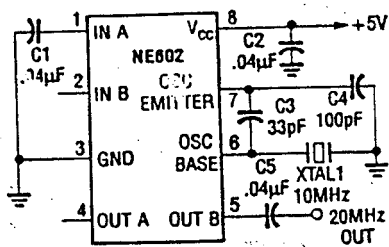

FIG. 11.—THIS FREQUENCY DOUBLER PRODUCES a sine wave at twice the frequency OF XTAL1. Note that output is taken only from out b (pin 5), while out a (pin 4) is left open.

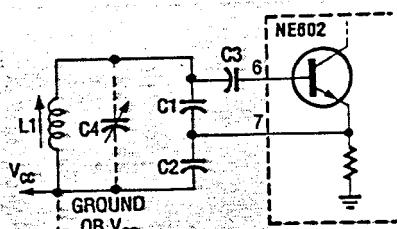

FIG. 12.—COLPITTS LC OSCILLATOR. Here: $L1=7 \mu\text{H}/f$, $C1=C2=C3=2400 \text{ pF}/f$, where f is in MHz.

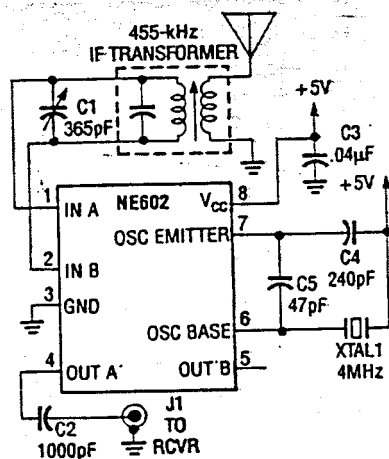

FIG. 13.—THIS CONVERTER DOWN-CONVERTS LONGWAVE signals from 350–500 kHz up to 4.35–4.5 MHz, enabling them to be received via a shortwave receiver plugged into J1.

Longwave receiver converter

Figure 13 shows a frequency converter front end for a shortwave receiver to receive longwave signals (350–500 kHz). It mixes the incoming signal with the 4-MHz signal from the LO. For example, 400 kHz incoming produces 4.4 and 3.6 MHz. The shortwave receiver will receive the signal if tuned to either frequency. The input has a tuned LC circuit to prevent spurious response.

If the receiver is set to 4.4 MHz, then without the tuned LC circuit you'd listen to 400 kHz and 8.4 MHz, because each gives a 4.4-MHz output when mixed with the LO. The tuned

LC circuit at the input selects one and rejects the other. This circuit was attached to a shortwave receiver, and immediately received several longwave navigational beacons in nearby states. A long wire antenna works, but loops pick up less noise because they are directional.

Direct-conversion receiver

A frequency converter can shift frequencies up or down. However, if you shift an RF signal down to audio, you get an audio signal. This is called direct-conversion reception, and can demodulate Single-Sideband (SSB) and Morse code Continuous-Wave (CW) transmissions. It demodulates AM, but there's a whine if the tuning isn't perfect.

Figure 14 shows such a direct-conversion receiver for the 40 meter band (7.5 MHz), that was able to receive several amateur radio stations using a 3-foot whip antenna. The design could be refined; tuning would be easier with a variable capacitor instead of an adjustable coil.

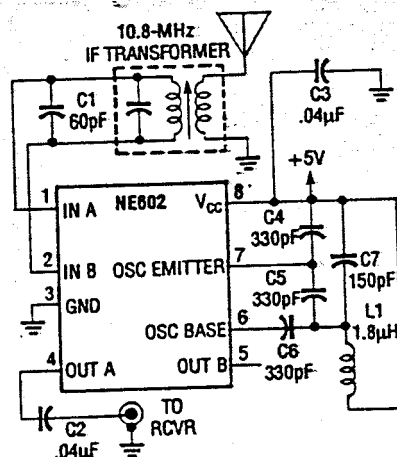

FIG. 14.—DIRECT-CONVERSION RECEIVER for the 40-meter (7-MHz) amateur radio band, where CW is directly down-converted to audio.

Conclusion

There are basically three RF circuit types—amplifiers, oscillators, and frequency converters. The NE602 makes frequency conversion easier than ever. Both it and related IC's will eventually become basic building blocks of RF design. This article has only scratched the surface of the possibilities for the NE602. In an IF section, it makes a good product detector. By mixing audio with RF, it can act as an AM or DSB modulator. By mixing audio with audio, the

NE602 can be the heart of an ultrasonic listener (by down-converting high-frequency audio) or a speech scrambler to add security to telephone conversations.

You can get NE602's at \$2.00 each, plus \$2.50 per order postage and handling per order, from the Small Parts Center, 6818 Meese Drive, Lansing, MI 48911, (517) 882-6447; there's no minimum order. They're also available from Arrow Electronics, Schweber Electronics, and many other Signetics distributors, with \$25.00 typical minimum orders. Be sure to specify whether you want the NE602N (8-pin DIP) or NE602D (surface mount package).

You also may prefer to order the NE602A, which will be replacing the NE602 imminently; it has somewhat improved intercept characteristics, resulting in less harmonic generation and intermodulation distortion. To specify the desired package type, you'd refer to the NE602AN or NE602AD. We would like to thank Phil Anzalone, Ali Fotowat, and Craig Hirtz of Signetics for their invaluable assistance in preparing this article. R-E

POWER LINE GLITCHES

continued from page 42

13–16. Figure 13 shows a normal power sinusoid, Fig. 14 shows harmonic distortion, Fig. 15 shows a brief glitch, and Fig. 16 shows a brief power outage.

Conclusion

Those graphs shown in Figs. 8–16 show only a few of many possible disturbances. Power glitches are common and readily identified. Most are easily fixed, the culprit often being poor wiring, bad grounding, or load switching—all can be corrected cheaply. The most common, practical countermeasure is to install a separate power line from the circuit-breaker box involved to the device being interfered with, like a PC.

Power monitors make identification easy, but they're generally too expensive, and would be needed too infrequently, to warrant purchase by the average hobbyist. They can, however, be rented for short periods, on an as-needed basis, letting you derive the benefits of their technology without making a major investment. R-E